

# The 2<sup>nd</sup> International Conference

of Multidisciplinary Approaches on UN Sustainable Development Goals (UNSDGs)

December 28<sup>th</sup> - 29<sup>th</sup>, 2017

at the Hotel Windsor Suites & Convention, Bangkok, Thailand

Organized by



## Contact Us

Research and Development Institute, Nakhon Pathom Rajabhat University,  
85 Malaiman Rd., Muang, Nakhon Pathom, 73000, Thailand.  
Tel. : +66 (0)34 109 300 Ext. 3909, +66 (0)34 261 053  
Fax. : +66 (0)34 261 053  
E-mail : [unsdgs2017@webmail.npru.ac.th](mailto:unsdgs2017@webmail.npru.ac.th)  
Website : <http://dept.npru.ac.th/unsdgs2017>

# The 2<sup>nd</sup> INTERNATIONAL CONFERENCE

of Multidisciplinary Approaches on UN Sustainable Development Goals (UNSDGs)



December 28<sup>th</sup> - 29<sup>th</sup>, 2017

at the Hotel Windsor Suites & Convention, Bangkok, Thailand



UNSDGs 2017



The 2<sup>nd</sup> International Conference of Multidisciplinary Approaches on UN Sustainable Development Goals (UNSDGs)



# PROCEEDINGS

## The 2<sup>nd</sup> International Conference of “Multidisciplinary Approaches on UN Sustainable Development Goals” (UNSDGs)

December 28<sup>th</sup> – 29<sup>th</sup>, 2017  
at the Hotel Windsor Suites & Convention,  
Bangkok, Thailand



## **Program and Abstracts**

### **The 2<sup>nd</sup> International Conference of “Multidisciplinary Approaches on UN Sustainable Development Goals” (UNSDGs)**

December 28<sup>th</sup> – 29<sup>th</sup>, 2017

Hotel Windsor Suites & Convention, Bangkok, Thailand

**Co-hosted by:** - The Interdisciplinary Network of the Royal Society of Thailand under the Royal Patronage of Her Royal Highness Princess Maha Chakri Sirindhorn

- Loei Rajabhat University
- Department of Medical Services, Ministry of Public Health
- Mahamakut Buddhist University
- National Office of Buddhism
- Faculty of Environment and Resource Studies, Mahidol University
- Faculty of Nursing, Prince of Songkla University
- Center for Research and Development in Community Health System, Faculty of Nursing, Khon Kaen University
- University of Kassel, the Federal Republic of Germany
- Undiknas University, the Republic of Indonesia
- Curtin University, the Commonwealth of Australia

**Editors:** Asst.Prof.Dr.–Ing.Phatcharasak Arlai  
Asst.Prof.Dr.Supoj Hengprapohm  
Dr.Udsanee Pakdeetrakulwong  
Miss Suparpitch Chanin  
Miss Ladda Khemnark

**Published by:** Research and Development Institute  
Nakhon Pathom Rajabhat University  
85 Malaiman Road, Mueang, Nakhon Pathom 73000  
Thailand  
Tel./Fax: +66 (0) 34 261053  
Website: <http://dept.npru.ac.th/unsdgs2017>  
Email: [unsdgs2017@webmail.npru.ac.th](mailto:unsdgs2017@webmail.npru.ac.th)

**Available online at:** <http://dept.npru.ac.th/unsdgs2017>

No.	Nationality	Number of Participants
1	Thai	284
2	German	6
3	Indian	3
4	American	4
5	Chinese	7
6	Filipinos	3
7	Japanese	4
8	Australian	2
9	Burmese	5
10	Pakistanis	2
11	Finns	1
12	Indonesian	4
13	Iraqis	1
14	Korean	1
15	Laotian	1
16	Sri Lankan	1
17	Taiwanese	1
<b>Total</b>	330 Participants	

#### Summary of participants

Thai participant 86.06 %

Foreign participant 13.94%

No.	Country	Number of Papers
1.	The Kingdom of Thailand	112
2.	The United States of America (USA)	2
3.	The Republic of Finland	1
4.	The Republic of Indonesia	1
5.	The Republic of the Union of Myanmar	1
6.	The Islamic Republic of Pakistan	2
7.	The Commonwealth of Australia	3
8.	The Republic of Iraq	1
9.	The Republic of Korea (South Korea)	3
10.	The Democratic Socialist Republic of Sri Lanka	1
11.	The Republic of China	1
12.	The People's Republic of Bangladesh	2
<b>Total</b>	130 papers	

#### Summary of Papers

Papers from Thailand % 86.15%

Papers from other countries % 13.84%



## **Message from Acting President of Nakhon Pathom Rajabhat University**

The 2<sup>nd</sup> International Conference of "Multidisciplinary Approaches on UN Sustainable Development Goals" (UNSDGs) is the second academic international conference of Nakhon Pathom Rajabhat University. On behalf of Acting President of Nakhon Pathom Rajabhat University, I am delighted to host and co-hosted with 11 organizations including the Interdisciplinary Network of the Royal Society of Thailand under the Royal Patronage of Her Royal Highness Princess Maha Chakri Sirindhorn, Loei Rajabhat University, Department of Medical Services, Ministry of Public Health, Mahamakut Buddhist University, National Office of Buddhism, Faculty of Environment and Resource Studies, Mahidol University, Faculty of Nursing, Prince of Songkla University, Center for Research and Development in Community Health System, Faculty of Nursing, Khon Kaen University, University of Kassel, the Federal Republic of Germany, Curtin University, Commonwealth of Australia, and Universitas Pendidikan Nasional (Undiknas University), the Republic of Indonesia.

The aims of UNSDGs is to provide a forum for academicians and professionals from various educational fields and with cross-disciplinary interests to network, share knowledge and engage in dialogue around the theme of fostering innovation and excellence in multidisciplinary approaches on UN sustainable development goals to produce a set of universally applicable goals that balances the three dimensions of sustainable development: environmental, social, and economic.

I would like to take this opportunity to express my sincere appreciation to Prof.Dr. Phra Brahmapundit, the president of Mahachulalongkornrajavidyalaya University, and Prof. Dr. rer. nat. Manfred Koch – the plenary lecturers, co-hosts, many distinguished international and Thai academicians that have presented their important research works, the conference organizing committees and all supporters who have contributed their resources to the conference with a great determination. Last but not least, I would also like to thank the working team who delicate themselves to achieve the conference.

In conclusion, I am honor to express my heartfelt appreciation to all participants, especially those of you coming from abroad, for joining us and sharing your valuable experience and ideas and wish our visitors will enjoy the conference and have a very pleasant stay in Thailand.

(Assistant Professor Somdej Ninlapan)  
Acting President of Nakhon Pathom Rajabhat University



**Message from  
Chairman of the Interdisciplinary Committee  
for Research and Development  
of the Royal Society of Thailand**

On behalf of the Chairman of the Interdisciplinary Committee for Research and Development of the Royal Society of Thailand, we have co-worked with Nakhon Pathom Rajabhat University since 2011. Herewith the President of Nakhon Pathom Rajabhat University performs as a Chairman of Western Network of the Royal Society of Thailand.

Since then, we have cooperated for publishing Journal of Thai Interdisciplinary Research until now. And I am the Editor of Journal of Thai Interdisciplinary Research.

In the present, Journal of Thai Interdisciplinary Research is indexed in the tier 1 (Science and Technology) of TCI, ASEAN Citation Index (ACI) and Google Scholar.

Moreover, the conference is mainly hosted by Nakhon Pathom Rajabhat University and the Interdisciplinary Committee for Research and Development of the Royal Society of Thailand. The selected articles will be published on the Journal of Thai Interdisciplinary Research.

Finally, I would like to express the deep appreciation to plenary lectures, keynote speakers, all participants and working staffs whom devote themselves to this conference.

I further wish the 2<sup>nd</sup> International Conference of Multidisciplinary Approaches on UN Sustainable Development Goals (UNSDGs) to be a great success and wish all participants a pleasant stay in Thailand, to have extensive and successful academic exchanges on the importance of interdisciplinary research from the conference, and safe trip back home.

(Professor Dr. med. Yongyudh Vajaradul, FRST)  
Chairman of the Royal Society of Thailand

## **Report Speech**

by Dr. Wirat Pinkaew,  
Vice president, Nakhon Pathom Rajabhat University, Thailand  
at the opening of the 2<sup>nd</sup> International Conference  
of Multidisciplinary Approaches on UN Sustainable Development Goals (UNSDGs)  
December 28<sup>th</sup>, 2017  
at the Hotel Windsor Suites & Convention, Bangkok, Thailand

Good morning, Prof. Dr. Phra Brahmapundit, the president of Mahachulalongkornrajavidyalaya University, Prof. Dr. med. Yongyudh Vajaradul, Chairman of the Interdisciplinary Committee for Research and Development of the Royal Society of Thailand, Prof. Dr. rer. nat. Manfred Koch, Faculty of Civil and Environmental Engineering, University of Kassel, Germany, fellow academicians, distinguished guests, ladies and gentlemen.

On behalf of the organizing committee of the 2<sup>nd</sup> International Conference on Multidisciplinary Approaches to Sustainable Development Goals (UNSDGs), we would like to express our gratitude to Mr. Prasit Pathummarak, Chairman of the University Council of Nakhon Pathom Rajabhat University to preside over the opening ceremony of this international conference.

With Thailand 4.0 being the Thai government's strategic vision and globally, United Nations Sustainable Development Goals being the path, the direction and destination that every country on earth are set to go. These are the themes reflected in this conference. Therefore, we would like to invite all of our partners to become part of the solution by rising up to the challenge of future shifts. The purpose of this international academic conference is to serve as an interdisciplinary exchange forum for faculties, students, researchers and academicians both here and abroad. Those who attend our event can expect to be enriched by the many interesting and relevant research topics of our time. All of the research topics both in the form of oral presentation and poster presentation have carefully been selected by experts in the fields.

Abstracts of selected research papers are published in the abstract proceedings book while the full paper can be accessed online via the conference website. All information therein will be sent to university libraries nationwide and related agencies. In addition, the full content of selected high-quality research papers will be published in the academic journal of Thai Interdisciplinary Research which are in the Thai Journal Citation Index (TCI) and ASEAN Citation Index (ACI).

This international conference covers 12 academic disciplines: (1) Sustainable Development Goals; (2) Pure and Applied Science; (3) Electrical Engineering and Technology; (4) Computer and Information Technology; (5) Medical Health Sciences and Laws; (6) Nursing; (7) Humanities and Social Sciences; (8) ASEAN Studies; (9) Water Engineering, Groundwater Hydrology and Environmental Science; (10) Hospitality and Tourism Management; (11) Interdisciplinary Research; and (12) Buddhism for Thailand 4.0.

There have been 160 articles submitted for review out of which 130 articles were selected for presentation in this conference: 107 in the form of oral presentations and 23 in the form of poster presentations.

In addition, there are as many as 65 agencies and organizations showing interests to present their ideas and articles so with amazing array of presentations during this festive seasons. The Organizing Committee invite all our academic partners and audience to please regard the timing of this international conference as a celebration of knowledge and our New Year Gifts for you.

I will now return the microphone back to the MC to announce the next step of formality.

Thank you for your attention.

Dr. Wirat Pinkaew, Vice president, Nakhon Pathom Rajabhat University, Thailand

## **Organizing Committee**

### **Chairman of UNSDGs**

Asst.Prof.Somdej Ninlapan

### **Advisory Committees**

Prof.Dr.med.Yongyudh Vajaradul

Dr.Wirat Pinkaew

### **International and national Academic Committees**

Prof.Dr.Archie A. Alexander

Prof.Dr.Grant A. Ramm

Prof.Dr.Adrian C. Sleigh

Prof.Dr.Ken Kurasaki

Prof. Dr. HongJoo Kim

Prof.Dr.Leslie Barratt

Prof.Dr.Masami MATSUDA

Prof.Dr.Wasantha Rathnayake

Prof.Viorel Sandu

Prof.Dr rer.nat.Manfred Koch

Prof.Dr.Shoichiro Hara

Prof.Dr.Thomas A.C Weiser

Prof.Dr.Warren Y. Brockelman

Assoc.Prof.Dr.Indrit Troshani

Assoc.Prof.Dr.Luh Putu Mahyuni

Asst.Prof.Dr.Bowie, Po-Yi Hsu

Dr.Amber Bajpai

Dr. Lin Min Min Myint

Dr.Meena Laiphrakpam

Dr.Benjamin C. Schulte



Dr.Dedy Syamsuar

Dr.Gordon Yan

Dr.Juniastel Rajagukguk

Dr.Nicola Palmer

Dr.Omid Ameri Sianaki

Dr.Ponnie Clark

Dr.Imran Haider

Dr.Rui Su

Dr.Samantha Chaperon

Dr.Will Barratt

Dr. Christie Yu –Ling Chang

Mrs.Ruffel Joy C. Manalo

H.E.Ambassador Kamthorn Sithtichoti

Prof.Dr.Budsaba Kanoksilapatham

Assoc.Prof.Dr.Boonyang plangklang

Assoc.Prof.Dr.Sunutra Taboonpong

Assoc.Prof.Dr.Piya Kovintavewet

Assoc.Prof.Dr.Jakrapong Kaewkhao

Assoc.Prof.Dr.Sayam Aroonsrimorakot

Assoc Prof.Dr.Singhanat Nomnian

Assoc.Prof.Dr.Sita Yiemkuntithavorn

Assoc.Prof.Dr.Tuantun Kitpaisalsakul

Asst.Prof.Dr.–Ing.Phatcharasak Arlai

Asst.Prof.Dr.Supoj Hengpraproh

Asst.Prof.Dr.Aumaporn Arlai

Asst.Prof.Dr.Hatchaichanok Buajaroen

Asst.Prof.Dr.Kamonpan Boonkit

Asst.Prof.Dr.Patarawagee Yasaka

Asst.Prof.Dr.Pitchayapa Yuenyaw

Asst.Prof.Dr.Piyaporn Tunneekul

Asst.Prof.Dr.Pragasit Sitthikul

Asst.Prof.Dr.Santi KoonKarnKhai

Asst.Prof.Dr.Suvimol Mukviboonchai

Asst.Prof.Dr.Theranun Wannasiri

Asst.Prof.Dr.Usa Noytim

Asst.Prof.Dr.Warakorn Poonsawat

Col.Archa Boongrapu

Acting 2, Lt.Pornchai Eiamsadthakul

Dr.Adisak Jaturapiree

Dr.Kairung Hengpraprom

Dr.Kitipun Boon-in

Dr.Maslin Buaban

Dr.Nipon Chuamuangphan

Dr.Nuttawan Pumdeeying

Dr.Orapun Metadilogkul

Dr.Pitiphol Pholpabu

Dr.Prapon Leksuma

Dr.Prasutr Thavornchaisit

Dr.Puvanart Keoplang

Dr.Supote Prasertsri

Dr.Thada Siththada

Dr.Thanathorn Vajirachorn

Dr.Udsanee Pakdeetrakulwong

Dr.Worachet Uttha

Mr.Nupong Phusri

Mr.Surachai Yusuk

Mr. Yanapat Yodkaew

Ms. Duangjit Sukhapabsuk

Ms. Lalana Pathomchaiwat

Ms. Nareema Sangwiman

Ms. Nilubon Kongprem

Ms. Ruja Sukpat

Ms. Thiranum Phrathum

**Assistant Secretary**

Ms. Ladda Khemnark

Ms. Suparpitch Chanin

Thai committees 56 persons

Foreign committees 32 persons

Total 88 persons

## List of Peer Reviews

H.E.Ambassador Kamthorn Sithichoti	Ministry of Foreign Affairs, Thailand
Col.Artcha Boongrapu	Ministry of Defence, Thailand
Assoc.Prof.Dr.Jakrapong Kaewkhao	Nakhon Pathom Rajabhat University, Thailand
Assoc.Prof.Dr.Smit Insiripong	Muban ChomBueng Rajabhat, Thailand
Dr. Juniastel Rajagukguk	Medan State University, Indonesia
Prof.Dr.Wasantha Rathnayake	Sabaragamuwa University of Sri Lanka Sri Lanka
Prof.Viorel Sandu	National Institute of Materials Physics, Romania
Dr. Lin Min Min Myint	School of Information Technology, Shinawatra University, Thailand
Dr. Ambar Bajpai	School of Engineering, Avantika University, Ujjain, India
Assoc.Prof.Dr.Piya Kovintavewat	Nakhon Pathom Rajabhat University, Thailand
Assoc.Prof.Dr.Phayung Meesad	King Mongkut's University of Technology North Bangkok, Thailand
Assoc.Prof.Dr.Prachyanun Nilsook	King Mongkut's University of Technology North Bangkok, Thailand
Assoc.Prof.Dr.Nuanwan Soonthornphisaj	Kasetsart University, Thailand
Associate Professor Dr. Indrit Troshani	The University of Adelaide, Australia
Dr. Dedy Syamsuar	Computer Science Faculty, Bina Darma University, Indonesia
Dr. Omid Ameri Sianaki	College of Engineering and Science, Victoria University Sydney Australia, Australia
Dr. Imran Haider	Curtin University, Australia
Dr. Orapan Methadilokul	The Medical Council of Thailand
Dr. Prasutr Thawornchaisit	Department of Medicine, Thailand
Prof.Dr.Archie A. Alexandder	Louisiana State University, United States of America
Assoc.Prof.Dr.Khanitta Nuntaboot	Khon Kaen University, Thailand
Prof. Dr.Shoichiro Hara	Kyoto University, Japan
Prof. Dr. Masami Matsuda	Tokyo Kasei-gakuin University, Japan

Assoc.Prof.Dr.Singhanat Nomnian	Mahidol University, Thailand
Assoc.Prof.Dr.Sita Yiemkuntitavorn	Sukhothai Thammathirat Open University, Thailand
Prof. Dr. Will Barratt	Roi Et Rajabhat University, Thailand
Asst.Prof.Dr.Pitchayapa Yuenyaw	Nakhon Pathom Rajabhat University, Thailand
Dr.Thada Siththada	Nakhon Pathom Rajabhat University, Thailand
Assoc.Prof.Dr.Tuantan Kitpaisalsakul	Chulalongkorn University, Thailand
Asst.Prof.Dr.Phatcharasak Arlai	Nakhon Pathom Rajabhat University, Thailand
Prof. Dr. rer. nat. Manfred Koch	University, University of Kassel, Germany
Assoc.Prof.Dr.Narin Sungrugsa	Silpakorn University, Thailand
Dr.Nipon Chuamuangphan	Nakhon Pathom Rajabhat University, Thailand
Dr. Rui Su	Middlesex University, London, United Kingdom
Dr. Nicola Palmer	Sheffield Hallam University, United Kingdom
Asst. Prof. Dr. Bowie, Po-Yi Hsu	National Kaohsiung University of Hospitality and Tourism, Taiwan
Dr. Samantha Chaperon	University of Greenwich, United Kingdom
Dr. Gordon Yan	Coventry University, United Kingdom
Assoc.Prof.Dr.Sayam Aroonsrimorakot	Mahidol University, Thailand
Dr.Meena Laiphrakpam	Mahidol University, Thailand
Asst.Prof. Warakorn Poolsawat	Nakhon Pathom Rajabhat University, Thailand
Dr. Christie Yu –Ling Chang	National Taiwan University, Taiwan

Thai reviewers 24 persons

Foreign reviewers 18 persons

Total 42 persons



**The Conference Program**  
**The 2<sup>nd</sup> International Conference**  
**of “Multidisciplinary Approaches on UN Sustainable Development Goals” (UNSDGs)**  
**December 28<sup>th</sup> – 29<sup>th</sup>, 2017**  
**at the Hotel Windsor Suites & Convention, Bangkok, Thailand**

Conference Program on December 28 <sup>th</sup> , 2017 (Day 1)	
Date/Time	Description
08.30 - 09.00	Registration
09.00 - 09.30	<b>Conference Opening</b> <u>Report:</u> Dr. Wirat Pinkaew, Vice president, Nakhon Pathom Rajabhat University, Thailand <u>Welcome Speech:</u> Prof. Dr. med. Yongyudh Vajaradul, Chairman of the Interdisciplinary Committee for Research and Development of the Royal Society of Thailand <u>Opening Speech:</u> Mr. Prasit Pathummarak President of Nakhon Pathom Rajabhat University Council, Thailand
09.30 - 10.30	<u>Plenary Lecture</u> Prof. Dr. Phra Brahmaphundit, the president of Mahachulalongkornrajavidyalaya University Topic: “Spiritual Transformation”
10.30 - 11.00	<u>Presenting a Token of Appreciation:</u> Mr. Prasit Pathummarak, President of Nakhon Pathom Rajabhat University Council for Plenary Lecture and Conference Co-organizers, (1) Dr. Phra Brahmaphundit (2) Prof. Dr. rer. nat. Manfred Koch (3) The Interdisciplinary Network of the Royal Society of Thailand under the Royal Patronage of Her Royal Highness Princess Maha Chakri Sirindhorn (4) Loei Rajabhat University (5) Department of Medical Services, Ministry of Public Health (6) Mahamakut Buddhist University (7) National Office of Buddhism (8) Faculty of Environment and Resource Studies, Mahidol University (9) Faculty of Nursing, Prince of Songkla University (10) Center for Research and Development in Community Health System, Faculty of Nursing, Khon Kaen University (11) University of Kassel, the Federal Republic of Germany (12) Curtin University, Commonwealth of Australia and (13) Universitas Pendidikan Nasional (Undiknas University), the Republic of Indonesia. <u>Commemorative Group Photo</u>
11.00 - 12.00	Plenary Lecture: Prof. Dr. rer. nat. Manfred Koch, Faculty of Civil and Environmental Engineering, University of Kassel, Germany Topic: “Flood Disasters and their Mitigation in the Wake of Climate Change with a Focus on Thailand Case Studies”
12.00 - 13.00	Lunch (Fl. G)
13.00 - 14.00	Keynote Address /Oral Presentations
14.00 - 15.00	Keynote Address /Oral Presentations
15.00 - 15.15	Poster Presentations & Coffee Break
15.15 - 17.00	Oral Presentations (continued)
18.00 - 20.00	Reception

**Conference Program on December 29<sup>th</sup>, 2017 (Day 2)**

<b>Date/Time</b>	<b>Description</b>
08.30 - 09.00	Registration
09.00 - 10.00	Keynote Address / Presentations
10.00 - 10.30	Oral Presentations
10.30 - 10.45	Coffee Break
10.45 - 12.00	Oral Presentations (continued)
12.00 - 13.00	Lunch (F.I.G)

# **Oral Presentation Program**



<b>BOARDROOM 1 (Fl. G)</b>		
<b>Session: ASEAN Studies</b>		
<b>Session Chair:</b> Asst.Prof.Dr.Pitchayapa Yuenyaw, Dr.Thada Sithhada, Ms.Lalana Pathomchaiwat and Dr.Nuttawan Pumdeeying		
<b>Dec 28<sup>th</sup>, 2017</b>		
<b>Time</b>	<b>Code</b>	<b>Title</b>
13.00 - 14.00	<b>Keynote Speaker</b>	<b>Assist. Prof. Dr. Rugphong Vongsaroj</b> <b>Topic: "Influence of Mainland China on Tourism Industry in ASEAN"</b>
14.00 - 14.15	AEC 1	<b>The Impact of ASEAN Coalition on English Teaching in Thailand</b> by Lalana Pathomchaiwat
14.15 - 14.30	AEC 3	<b>Implementation Guidelines for Electronic Waste Disposal Management in Thailand to be Sustainable Developing Country in ASEAN</b> by Phongchayont Srisuwan
14.30 - 14.45	AEC 5	<b>Weaving Southeast Asian Identities: Strengthening ASEAN Socio-Cultural Community</b> by Aryasatyani Dhyani

<b>BOARDROOM 2 (Fl.G)</b>		
<b>Session: Hospitality and Tourism Management</b>		
<b>Session Chair:</b> Dr.Thanathorn Vajirakachorn, Dr.Nipon Chuamuangphan, Dr.Maslin Buaban, Dr.Prapon Leksuma and Ms.Nilubon Kongprem		
<b>Dec 28<sup>th</sup>, 2017</b>		
<b>Time</b>	<b>Code</b>	<b>Title</b>
13.00 - 14.00	<b>Keynote Speaker</b>	<b>Dr.Thanathorn Vajirakhachorn</b> <b>Topic: "Tourism and Sustainability Development"</b>
14.00 - 14.15	TOUR 1	<b>Importance of Hotel Brand Equity in Hospitality Industry</b> by Rachata Wangchan and Kreetha Simavara
14.15 - 14.30	TOUR 2	<b>Guidelines for Management of Kew Mae Pan and Pha Mon Nature Trail, Doi Inthanon National Park, Chiang Mai Province, Northern Thailand</b> by Nareerat Thanakasem, Panjarat Samanasena, Chonticha Pansawang, Jakkrit Charoensit and Pitoon Amornwithhawatt
14.30 - 14.45	TOUR 3	<b>Comparing Performance of Centralized and Non-Centralized Safety Stock Case Study: Retail Clothing Business</b> by Supreechaya Bunmak, Nathawan Samakachan and Arisara Thaneerananon
14.45 - 15.00	TOUR 4	<b>Demand Fluctuation in The Fine Dining Restaurant Industry; Patterns, Impacts, and Management Strategies (A case study in Phuket)</b> by Wiphaporn Jobrich and Pornpisanu Promsivapallop
15.00 - 15.15	TOUR 5	<b>Can 'Tourism Product Development' Compensate the Social Cost of Carbon Pollution? : A Case Study in Sri Lanka</b> by Wasantha Rathnayake and Rajapaksha
15.15 - 15.30	TOUR 6	<b>The Potential of Agriculture based Destinations for Developing Creative Tourism: A Case Study of Ko Lad E-Tan, Nakhon Pathom Province, Thailand</b> by Maslin Buaban and Khaunyupa Srisawang

<b>BOARDROOM 2 (FI.G)</b>		
<b>Session: Hospitality and Tourism Management</b>		
<b>Session Chair:</b> Dr.Thanathorn Vajirakachorn, Dr.Nipon Chuamuangphan, Dr.Maslin Buaban, Dr.Prapon Leksuma and Ms.Nilubon Kongprem		
<b>Dec 28<sup>th</sup>, 2017</b>		
<b>Time</b>	<b>Code</b>	<b>Title</b>
15.30 - 15.45	TOUR 7	<b>Guidelines for Community Participation in the Woven Fabric Conservation for Cultural Tourism in Phai Hu Change Community in Banglane District, Nakhon Pathom Province</b> by Pimchanok Mulmit, Jitsupa Rungraung, Bootsarakorn Khunnarong, Suttipong Aiemnoo and Supansa Paethong
15.45 - 16.00	TOUR 8	<b>The Participatory Approach to Environmental Management for Tourism in Wat Klang Khu Wiang Floating Market, Sampathuan Subdistrict, Nakhon Chai Si District, Nakhon Pathom Province</b> by Tiranan Pratum
16.00 - 16.15	TOUR 9	<b>The Guidelines for Public Relations and Tourism Promotion of the Wat Tha Phut Folk Museum, Rai Khing Subdistrict, Sam Phran District, Nakhon Pathom Province</b> by Nilubon Kongprem and Prapon Leksuma
16.15 - 16.30	TOUR 10	<b>The Potential on Tourism Activities at Hot Springs in Thai-Lanna Tourism Cluster</b> by Dr.Nipon Chuamuangphan

<b>AMPAWA 1 (FI.10)</b>		
<b>Session: Sustainable Development Goals</b>		
<b>Session Chair:</b> H.E. Ambassador Kamthorn Sithichoti and Col. Artcha Boongrapu		
<b>Dec 28<sup>th</sup>, 2017</b>		
<b>Time</b>	<b>Code</b>	<b>Title</b>
13.00 - 13.15	SDGs 1	<b>Sustainable Development Goals (SDGs): 1 and 5 –Complementary towards Fulfilment of Goals through BNF grant: An Analysis among the Beneficiaries</b> by Muhammad Mahboob Ali, Kamrul Hossain and Alauddin Chowdhury
13.15 - 13.30	SDGs 2	<b>Theory on Community Banking for Empowerment of People Bangladesh: A Conceptual View</b> by Muhammad Mahboob Ali
13.30 - 13.45	SDGs 5	<b>Peaceful and Nonviolent Societies as a Sustainable Development Goal 16</b> by Ingrida Grigaitytė and Hasan Habes
13.45 - 14.00	SDGs 6	<b>UNESCO Global Geoparks: A new set of management tools for sustainable development and Satun Aspiring UNESCO Global Geopark</b> by Pakkaporn Singhwachiraworakul, Pratueng Jintasakul, Paul Grote and Narongrit Thungprue
14.00 - 14.15	SDGs 8	<b>Managing Sustainable Development</b> by Pradip Peter Dey, Ronald P. Uhlig, Laith Al Any and Mohammad Amin
14.15 - 14.30	SDGs 9	<b>Comparison Data Inventory of Two Limestone Quarries with Environmental Footprint Technique</b> by Thanapat Atikij and Sayam Aroonsrimorakot
14.30 - 14.45	SDGs 10	<b>Promoting Sustainable Development Goals through Corporate Social Responsibility (CSR) Practices: Cases of Rural Hotels in Bali, Indonesia</b> by Luh Putu Mahyuni and Teddy Prianthara

<b>AMPAWA 1 (Fl.10)</b>		
<b>Session: Pure and Applied Science</b>		
<b>Session Chair: Assoc.Prof.Dr.Jakrapong Kaewkhao, Dr.Patarawagee Yasaka and Dr.Kitipun Boon-in</b>		
<b>Dec 29<sup>th</sup>, 2017</b>		
<b>Time</b>	<b>Time</b>	<b>Time</b>
9.00 - 10.00	<b>Keynote Speaker</b>	<b>Prof. Dr. Ken Kurosaki</b> <b>Topic: "Thermoelectric Materials"</b>
10.00 - 10.15	SCI 1	<b>Effect of Cr<sub>2</sub>O<sub>3</sub> Concentrations on Physical and Optical Properties of Sodium Barium Bismuth Silicate Glasses</b> by Piyachat Meejitpaisan, Nattapon Srisittipokakun and Jakrapong Kaewkhao
10.15 - 10.30	SCI 2	<b>Study Structural, Physical and Optical Properties of Commercial Glass and Sunergy Clear Glass</b> by Pornnapha Mangthong, Nattapon Srisittipokakun, Jakrapong Kaewkhao
10.30 -10.45	SCI 3	<b>The Physical and Optical Parameters of Li<sub>2</sub>O – MO – B<sub>2</sub>O<sub>3</sub> Glasses Doped with Eu<sup>3+</sup>(MO = MgO, CaO, SrO, BaO)</b> by Benchaphorn Damdee, Jakrapong Kaewkhao and Keerati Kirdsiri
10.45 - 11.00	SCI 4	<b>Investigations on Spectroscopic Properties of Dy<sup>3+</sup> Ion in Zinc Barium Borotellurite Glasses</b> by Patarawagee Yasaka, Chananya Wongdeeying, Nisakorn Sangwanate, Pruittipol Limkitjaroenporn and Jakrapong Kaewkhao
11.00 - 11.15	SCI 5	<b>Fabrication and Study on Optical and Photoluminescence Properties of Europium Doped in Borate Glasses</b> by Kitipun Boonin, Patarawagee Yasaka and Jakrapong Kaewkhao
11.15 - 11.30	SCI 6	<b>Photon Interaction of WO<sub>3</sub>-Doped Soda Lime Borosilicate Glasses in Energy Range 1 keV to 105 keV:Theoretical Calculation</b> by Pruittipol Limkitjaroenporn, Wiraporn Hongtong and Jakrapong Kaewkhao
11.30 - 11.45	SCI 7	<b>The Photoluminescence Properties of Barium Gadolinium Borate Glasses doped with Dy<sup>3+</sup> Ions</b> by Keerati Kirdsiri, Kanthamane Kamsila and Narong Sangwanate
11.45 - 12.00	SCI 8	<b>PTR, PCR and Energy Resolution Study of BGO, CsI(Tl), and LYSO Scintillation Crystals</b> by Wasu Cheewasukhanont, Wuttichai Chaiphaksa, Pruittipol Limkitjaroenporn, and Jakrapong Kaewkhao
<b>AMPAWA 2 (Fl.10)</b>		
<b>Session: Pure and Applied Science</b>		
10.00 - 10.15	SCI 9	<b>Determination of Effective Atomic Number and Effective Electron Density of Some Local Building Materials in Nakhon Pathom Province</b> by Donlaporn Onta, Sirapong Klinhom, Wichita na Ayudhya and Keerati Kirdsiri
10.15 - 10.30	SCI 10	<b>Diversity of birds in Hlawga Park, Republic of the Union of Myanmar</b> by Aye Thant Zin, San San Myint, Myitzu Thinn Aung, Khun Aung Naing Oo, Kajornsak Jaiyawat, Chanatip Vongpraramat and Pongsarun Junshum
10.30 -10.45	SCI 11	<b>High Antibacterial Activity under Visible Light of WO<sub>3</sub>-Doped TiO<sub>2</sub> Thin Films</b> by Weerachai Sangchay and Phatcharee Phoempon
10.45 - 11.00	SCI 12	<b>Effects of CuO on Glass Prepared from Local Sand in Nakhon Pathom Province</b> by Watcharin Rachniyom, Narong Sangwanate and Jakrapong Kaewkhao

<b>AMPAWA 2 (Fl.10)</b>		
<b>Session: Pure and Applied Science</b>		
11.00 - 11.15	SCI 13	<b>A Negative Binomial-new Weighted Lindley Distribution for Count Data and Its Application to hospitalized Patients with Diabetes at Ratchaburi Hospital, Thailand</b> by Siriporn Samutwachirawong
11.15 - 11.30	SCI 14	<b>Luminescence Properties of Sm<sup>3+</sup> Ions doped Aluminium, Barium and Phosphate Glasses</b> by N. Kiwsakunkarn, Jintana Poosanapong, Yaowaluk Tariwong, Jakrapong Kaewkhao and Natthakridta Chanthima
11.30 - 11.45	SCI 15	<b>Physical and Optical Study of Alkali and Alkaline Earth Metals Based Phosphate Glasses</b> by M. Shoaib, N. Chanthima, G. Rooh and J. Kaewkhao
11.45 - 12.00	SCI 16	<b>High Performance Properties of Multi-Walled Carbon Nanotubes and Carbon Black in NR/SBR</b> by Phatcharee Phoempon, Weerachai Sangchay, Lek Sikong, Kalyanee Kooptanond and Orasa Patarapaiboolchai

<b>AMPAWA 2 (Fl.10)</b>		
<b>Session: Medical Health Sciences and Laws</b>		
<b>Session Chair:</b> Dr.Orapun Medilogkul, Dr.Prasutr Thawornchaisit, Acting2, Lt.Pornchai Eiamsadthakul		
<b>Dec 28<sup>th</sup>, 2017</b>		
<b>Time</b>	<b>Code</b>	<b>Title</b>
13.00 – 14.00	<b>Keynote Speaker</b>	<b>Dr.med.univ.Dr.rer.nat.Manfred Hartard and Mr. Dennis Bruns</b> <b>Topic: "Vibration Therapy Machines"</b>
14.00 – 15.00	<b>Keynote Speaker</b>	<b>Professor Dr.Grant A. Ramm</b> <b>Topic: "The Liver Stem Cell Niche: Role in Inflammation, Fibrogenesis and Regeneration in Chronic Liver Disease"</b>
15.00 - 15.15	MED 1	<b>Health Information Exposure, Health literacy and Health Promotion Behavior of Undergraduate Students of Kasetsart University</b> by Chalermkwan Singhwee
15.15 - 15.30	MED 2	<b>Influence of Astaxanthin on the Elicitation of Allergic Contact Dermatitis to P-Phenylenediamine: A Pilot Study</b> by Suphattra Trakanwittayarak, Jitlada Meephansan, Supitchaya Thaiwat and Suwimon Pootongkam
15.30 - 15.45	MED 3	<b>Transitional health-risk factors and associated 8-year nationwide incidence of hypertension in a Thai Cohort Study of 40,548 open university students</b> by Prasutr Thawornchaisit
15.45 - 16.00	MED 4	<b>Health-risk factors and 8-year incidence of kidney disease in Thailand: prospective findings from a large national cohort study</b> by Prasutr Thawornchaisit
16.00 - 16.15	MED 5	<b>Efficacy of combining fractional Carbon Dioxide laser and Silicone Gel in the treatment of hypertrophic scars and keloids</b> by Thanakom Sukcharoen and Suparuj Lueangarun
16.15 - 16.30	MED 6	<b>Effect of Calcipotriol on Uvb-Induced Mmp-9 In Human Skin: A Pilot Study</b> by Sasipa Limpikirati, Jitlada Meephansan and Saranyoo Ponnikorn
16.30 - 16.45	MED 7	<b>Clinical Status of Cerebral Palsy Patients Who used Cannabis Extract in Daily Life: A Survey</b> by Orapun Metadilogkul

<b>AMPAWA 2 (Fl.10)</b>		
<b>Session: Medical Health Sciences and Laws</b>		
<b>Session Chair:</b> Dr.Orapun Medilogkul, Dr.Prasutr Thavornchaisit, Acting2, Lt.Pornchai Eiamsadthakul		
<b>Dec 28<sup>th</sup>, 2017</b>		
<b>Time</b>	<b>Code</b>	<b>Title</b>
16.45 - 17.00	MED 8	<b>Pain Reduction among Patients used Cannabis extract as Self-Medication among Advanced Cancer Cases with Metastasis: A Survey</b> by Orapun Metadilogkul
17.00 - 17.15	MED 9	<b>Fasting Blood Glucose of Diabetes Mellitus Patients Who used Cannabis extract as Self-Medication: A Survey</b> by Orapun Metadilogkul

<b>AMPAWA 3 (Fl. 10)</b>		
<b>Session: The Interdisciplinary Research</b>		
<b>Session Chair:</b> Prof.Dr.med.Yongyudh Vajaradul, Dr.Waret Veerasai, Assoc.Prof.Dr.Wongchan Wongkaew and Asst.Prof.Dr.Lertsiri Bovornkitti		
<b>Dec 28<sup>th</sup>, 2017</b>		
<b>Time</b>	<b>Code</b>	<b>Title</b>
13.00 - 14.00	<b>Keynote Speaker</b>	<b>Prof. Dr. med. Yongyudh Vajaradul</b> <b>Topic: "The Interdisciplinary Research Methodology and Its Necessity for Thailand 4.0 Strategy"</b>
14.00 - 15.00	<b>Keynote Speaker</b>	<b>Prof.Dr.Warren Y. Brockelman</b> <b>Topic: "Gibbons, forests, and climate change"</b>
15.00 - 16.00	<b>Keynote Speaker</b>	<b>Dr. Supote Prasertsri</b> <b>Topic: "Higher Education for Thailand 4.0"</b>
16.00 - 16.15	ITR 1	<b>Review of Indicators on Active Ageing towards Sustainable Development in Thailand</b> by Meena Laiphrakpam and Sayam Aroonsrimorakot
16.15 - 16.30	ITR 4	<b>Evaluation of Business Simulation Laboratory Project Business Education Faculty of Management Science Nakhon Pathom Rajabhat University</b> by Pattaraporn Puisuwan, Arisara Thaneerananon and Kanchanut Nualnisachol
16.30 - 16.45	ITR 5	<b>The Strategic Planning Development for a Quality Active Ageing</b> by Rudchanok Sittivas
16.45 - 17.00	ITR 6	<b>Buddhist Institute with Creation for the Elderly Well-being Sustainable</b> by Sutthi Kabpila
17.00 - 17.15	ITR 7	<b>Local Herbs for Health Promotion: Grass Root Innovation C</b> by Poratip Chanchamsri
17.15 - 17.30	ITR 8	<b>Legal Measures to Support Coastal Communities for Sustainable Self-Governance in Global Climate Change</b> by Thitirat Itthimechai
17.30 - 17.45	ITR 9	<b>Property Management for Sustainable Livelihood of the Elderly</b> by Teerayuth Namkanisorn
17.45 - 18.00	ITR 10	<b>Grassroots Innovations with Local Foods</b> by Suthangrat Saisuwan
18.00 - 18.15	ITR 11	<b>Conflict Management between People and Forest Elephants according to the King Bhumibol's Science</b> by Somjate Ploychan

18.15 - 18.30	ITR 12	<b>Community Welfare System for the Elderly</b> by Natthawut upatham
<b>AMPAWA 3 (FI. 10)</b>		
<b>Session: The Interdisciplinary Research</b>		
<b>Session Chair:</b> Prof.Dr.med.Yongyudh Vajaradul, Dr.Waret Veerasai, Assoc.Prof.Dr.Wongchan Wongkaew and Asst.Prof.Dr.Lertsiri Bovornkitti		
<b>Dec 28<sup>th</sup>, 2017</b>		
<b>Time</b>	<b>Code</b>	<b>Title</b>
18.30 - 18.45	ITR 13	<b>Strategies for Adolescent Sexual Health Promotion based on Feminism</b> by Sumitra Niamkan
18.45 - 19.00	ITR 14	<b>Management of Coastal Fishing in the Thai-Cambodian Border for Sustainable Development</b> by Piyavut Prasitthiwed
19.00 - 19.15	ITR 15	<b>Environmental Education and Awareness among Students in India, Japan and Thailand for Sustainable Development</b> by Meena Laiphrakpam, Sayam Aroonsrimorakot and Aribam Rama Shanker

<b>PLOY (FI. 11)</b>		
<b>Session: Nursing</b>		
<b>Session Chair:</b> Asst.Prof.Dr.Hathaichanok Buajaroen, Asst.Prof.Dr.Pimsupa Shandanasotthi, Mrs. Natthaya Cherngchalard Chooprom, Asst.Prof.Dr.Theeranan Wannasiri, Ms.Laarnie D.Esteban, Ms. Labmie Lynnette Dematoque, Mrs. Ruffel Joy C. Manalo		
<b>Dec 28<sup>th</sup>, 2017</b>		
<b>Time</b>	<b>Code</b>	<b>Title</b>
13.00 - 14.00	<b>Keynote Speaker</b>	<b>Associate Prof. Dr. Khanitta Nuntaboot</b> <b>Topic: "Nursing Reform to promote Sustainable Development Goals"</b>
14.00 - 14.15	NUR 1	<b>Philippines' Public Health Nursing at a Glance</b> by Laarnie D. Esteban
14.15 - 14.30	NUR 2	<b>ASEAN Mutual Recognition Arrangement (MRA) on Nursing Services: Philippine's Challenges, Issues and Possible Way Forward</b> by Labmie Lynnette L. Dematoque
14.30 - 14.45	NUR 3	<b>Factors Related to Initiation of Cigarette Smoking Behavior among Secondary School Student in Nakhon Pathom Province</b> by Wanpen Waelveerakup, Malinee Jumrain and Prasinee Suksatapornlerte

<b>PLOY (FI. 11)</b>		
<b>Session: Nursing</b>		
<b>Session Chair:</b> Asst.Prof.Dr.Hathaichanok Buajaroen, Asst.Prof.Dr.Pimsupa Shandanasotthi, Mrs. Natthaya Cherngchalard Chooprom, Asst.Prof.Dr.Theeranan Wannasiri, Ms.Laarnie D.Esteban, Ms. Labmie Lynnette Dematoque, Mrs. Ruffel Joy C. Manalo		
<b>Dec 29<sup>th</sup>, 2017</b>		
<b>Time</b>	<b>Code</b>	<b>Title</b>
9.00 – 10.30	<b>Keynote Speaker</b>	<b>Prof. Dr.Shoichiro Hara</b> <b>Topic: "Community Evidences to support Sustainable Development Goals"</b>
10.30 – 12.00	<b>Keynote Speaker</b>	<b>Prof. Dr. Masami Matsuda</b> <b>Topic: "Sustainable Development Goals in Community"</b>

<b>MORAKOT 1 (Fl. 12)</b>		
<b>Session: Water Engineering, Groundwater Hydrology and Environmental Science</b>		
<b>Session Chair:</b> Assoc.Prof.Tuantan Kitpaisalsakul, Asst.Prof.Dr.Phatcharasak Arlai and Assoc.Prof.Dr.Sayam Aroonsrimorakot		
<b>Dec 28<sup>th</sup>, 2017</b>		
<b>Time</b>	<b>Code</b>	<b>Title</b>
13.00 – 14.00	<b>Keynote Speaker</b>	<b>Prof. Dr. rer. nat. Manfred Koch</b> <b>Topic: "The Impact of Climate Change on Streamflow and Sustainable Water Resources Management"</b>
14.00 – 14.15	WRE 1	<b>Factors Affecting Performance of Standard Application and Indicator for Greenhouse Gas Emission in Green Office, Thailand</b> by Sayam Aroonsrimorakot, Setrawut Phuynongpho and Supapan Athirot
14.15 - 14.30	WRE 2	<b>The Potential Solutions of Water Resource Problem in Cisarua Sub-District, Bogor, West Java, Indonesia</b> by M. Faisi Ikhwal and Titiek Ujjanti Karunia
14.30 - 14.45	WRE 3	<b>Multi-Objective Optimization for Flood Control Operation and Electricity Production of Nam Ngum 1 and 2 Hydropower Plants</b> by Vilandone Keophila, Anucha Promwungkwa and Kanchit Ngamsanroaj
14.45 - 15.00	WRE 4	<b>Effects of Light Intensity and Wind Velocity on the Evaporation Rate of Saturated Soil Surface</b> by Tammasak Punsasensri and Watcharapong Tachajapong
15.00 - 15.15	WRE 5	<b>Impacts of Climate Change on Irrigation Water Management by the Bhumibol Dam in Thailand</b> by Tuantan Kitpaisalsakul
15.15 - 15.30	WRE 6	<b>Application of the Tha-Chin River Model to early Flood Warning for Community Areas in the Bang Rakam Municipality, Central Thailand</b> by Phatcharasak Arlai and Manfred Koch

<b>MORAKOT 1 (Fl.12)</b>		
<b>Session: Computer and Information Technology</b>		
<b>Session Chair:</b> Dr.Supoj Hengpraprom, Dr.Kairung Hengpraprom, Dr.Worachet Uttha, Dr.Pitiphol Pholpabu, Dr.Udsanee Pakdeetrakulwong, Suksawat Sae-lim		
<b>Dec 29<sup>th</sup>, 2017</b>		
<b>Time</b>	<b>Code</b>	<b>Title</b>
9.00 - 10.00	<b>Keynote Speaker</b>	<b>Assoc. Prof. Dr. Thanachart Numnonda</b> <b>Topic: "Big Data Technology to drive Digital Economy"</b>
10.00 - 10.15	COM 1	<b>Applying an Extremely Imbalanced Technique on Big Data: Case Study of the Web Intrusion</b> by Kesinee Boonchuay, Sureerat Kaewkeeree and Youppadee Intasorn
10.15 - 10.30	COM 2	<b>A Multi-agent Approach for Semantic Annotation of Source Code Artefact</b> by Pornpit Wongthongtham, Udsanee Pakdeetrakulwong, Suksawat Sae-Lim, Worachet Uttha, Sutarat Chaonafang, Suphitcha chanrueang, Supakit Nakpomchin, Somkiat Chormuan
10.30 -10.45	COM 3	<b>Ontology-based Multi-agent Systems: An Overview of Existing Approaches</b> by Pornpit Wongthongtham, Udsanee Pakdeetrakulwong, Suksawat Sae-Lim, Atisak Chatcharoenporn
10.45 - 11.00	COM 4	<b>Multi-language Communication Protocol Model Based on Conceptual Spaces and Language Games</b> by Somjin Juntarajessadakorn, Vatinee Nuijian and Phayung Meesad

<b>MORAKOT 1 (Fl.12)</b>		
<b>Session: Computer and Information Technology</b>		
<b>Session Chair:</b> Dr.Supoj Hengpraprom, Dr.Kairung Hengpraprom, Dr.Worachet Uttha, Dr.Pitiphol Pholpabu, Dr.Udsanee Pakdeetrakulwong, Suksawat Sae-lim		
<b>Dec 29<sup>th</sup>, 2017</b>		
<b>Time</b>	<b>Code</b>	<b>Title</b>
11.00 - 11.15	COM 5	<b>Evaluation of Linux I/O Schedulers on SSD for HDFS</b> by Kritwara Rattanaopas, Sureerat Kaewkeeree, Sarapee Chunkaew and Supawadee Mak-on
11.15 - 11.30	COM 6	<b>Social Media Framework Incorporating Fuzzy Regression for Affective Design: State-of-the-art, Challenges, and Opportunities</b> by Pratima Jain, Pornpit Wongthongtham, and Kit Yan Chan
11.30 - 11.45	COM 7	<b>Service Measurement Tool for Internet Service Provider</b> by Somkiat Chormuan and Worachet Uttha
11.45 - 12.00	COM 8	<b>Ontology for Economic Performance Indicators Based on Global Reporting Initiative (GRI) G4</b> by Ilham S.Y. Yaldo and Udsanee Pakdeetrakulwong

<b>MORAKOT 2 (Fl. 12)</b>		
<b>Session: Buddhism for Thailand 4.0</b>		
<b>Session Chair:</b> Assist.Prof.Dr.Warakorn Poonswat, Dr.Puvanart Keoplang, Dr. Nathacha Thamthanapaisan, Mr.Yanapat Yodkaew		
<b>Dec 28<sup>th</sup>, 2017</b>		
<b>Time</b>	<b>Code</b>	<b>Title</b>
13.00 – 14.00	<b>Keynote Speaker</b>	<b>Mr. Charles G. Lief</b> <b>Topic: “Buddhism: Learning for Transform yourself, Transform the World”</b>
14.00 – 14.15	BUD 1	<b>Buddhism 4.0 for the “Spiritual but Not Religious”</b> by Thomas A.C Weiser
14.15 - 14.30	BUD 2	<b>Thai Buddhism 4.0: Transforming Buddhist Practices In-Depth, Inward, and Beyond</b> by Christie Yu-Ling Chang
14.30 – 14.45	BUD 3	<b>Child Growth and Development</b> by Chutarat Sathirapanya
14.45 - 15.00	BUD 4	<b>A Short History of Jin Nikāya in Thailand: Sociopolitical Perspective</b> by Bbhikṣu Shih Yuande
15.00 - 15.15	BUD 5	<b>Parents’ Hope for their Children with Special Needs</b> by Sermsep Vorapanya and Apison Parchanavon
15.15 - 15.30	BUD 6	<b>Buddhist Approaches on Welfare for a Nation</b> by Ven. Pandava
15.30 - 15.45	BUD 7	<b>Theravada Buddhism and Tea in Blang Minority Ethnic Identification: A Case Study of Laoman’e Hill Village in Xishuangbanna, Yunnan</b> by Ven. Wen'en Yan
15.45 - 16.00	BUD 8	<b>Is the Mind NOT the Brain? What is the Comparison of Mental Processing and the Computer?</b> by Chaiyen Ratnavijarn
16.00 - 16.15	BUD 9	<b>The Buddhist Effective Method for Solutions of Kāmarāga in the Modern Societies</b> by Ven. Dharma Rakshit Bhikkhu
16.15 - 16.30	BUD 10	<b>Sageliness Within and Kingliness Without: A Three-Dimensional Mandala and an Emperor’s Mindfulness Practice</b> by Jingyu Huang



16.30 – 16.45	BUD 11	<b>The Relationship between the 12 National Core Values Behaviors and Ethical Behaviors of Students in Nakhon Pathom Rajabhat University</b> by Praepat Yodkaew
16.45 - 17.00	BUD 12	<b>Buddhist CITTA Transformative Technology the Solution for the Unsustainable Development</b> by Chaiyen Ratnavijarn
17.00 - 17.15	BUD 13	<b>Happiness: Gimmick Buddhism for Thailand 4.0</b> by Natthacha Thamthanapaisarn

<b>MORAKOT 2 (Fl.12)</b>		
<b>Session: Electrical Engineering and Technology</b>		
<b>Session Chair:</b> Assoc.Prof.Dr.Piya Kovintavewat and Assoc.Prof.Dr.Santi Koonkarnkhai		
<b>Dec 29<sup>th</sup>, 2017</b>		
<b>Time</b>	<b>Code</b>	<b>Title</b>
09.00 - 09.15	EET 1	<b>Effect of Weather Change on Hydrogen Production via Electrolysis Powered by Photovoltaic System</b> by Rungchai Kaensako, Nawadee Srisiriwat and Anuchart Srisiriwat
09.15 - 09.30	EET 2	<b>Power Loss Comparison of Pulse Width Modulation Techniques Based on Space Vector Method by MATLAB/SIMULINK</b> by Kanitphan Boonsomchuae and Satean Tunyasrirut
09.30 - 09.45	EET 3	<b>Application of Artificial Neural Networks for the Wind Power Prediction in Nakhon Pathom</b> by Bopit Chainok
09.45 - 10.00	EET 4	<b>Design of Decentralized PID Controller with Root Locus Method based on Inverted Decoupling for TITO System</b> by Chananchai Wuthithanyawat, and Santi Wangnipparnto
10.00 - 10.15	EET 5	<b>Investigating Electric Vehicle (EV) Charging Station Locations for Agartala, India</b> by Somudeep Bhattacharjee Saima Batool, hampa Nandi and Udsanee Pakdeetrakulwong

<b>PAITON (Fl.33)</b>		
<b>Session: Humanities and Social Sciences</b>		
<b>Session Chair:</b> Prof.Dr.Budsaba Kanoksilapatham, Assoc.Prof.Sita Yiemkunttavorn, Assoc.Prof.Singhanat Nomnian, Asst.Prof.Dr.Pragasit Sitthitikul, Asst.Prof.Dr.Usa Noytim, Asst.Prof.Dr.Kamonpan Boonkit, Asst.Prof.Dr.Piyaporn Tunneekul, Ms.Duangjit Sukhapabsuk, Mr.Surachai Yusuks, Mr.Nupong Phusri		
<b>Dec 28<sup>th</sup>, 2017</b>		
<b>Time</b>	<b>Code</b>	<b>Title</b>
13.00 - 13.15	HUM 1	<b>The Impact of Perceived Transformational Leadership on Perceived Employee Creativity in Orchid Farming in Nakhon Pathom Province</b> by Panyindee Janjirapon, Hirannapat Minmantra and Thong-oon Woraya
13.15 - 13.30	HUM 2	<b>Determinants of Happiness in a Multicultural Setting: A Case of Chana district, Songkhla province, Thailand</b> by Nurainee Jangoe, Sarawuth Chesoh and Apiradee Lim
13.30 - 13.45	HUM 3	<b>The Comparative Study of Logistics Cost Structure for Farmers' Siamese Fighting Fish</b> by Hirannapat Minmantra, Sukcharoenpong Sompon and Ditsathaporncharoen Santi
13.45 - 14.00	HUM 4	<b>A study on the Psycho-Social Disturbance of Children who are exposed to Domestic Violence in South Korea</b> by Misook Cho

<b>PAITON (Fl.33)</b>		
<b>Session: Humanities and Social Sciences</b>		
<b>Session Chair:</b> Prof.Dr.Budsaba Kanoksilapatham, Assoc.Prof.Sita Yiemkunttavorn, Assoc.Prof.Singhanat Nomnian, Asst.Prof.Dr.Pragasit Sitthitikul, Asst.Prof.Dr.Usa Noytim, Asst.Prof.Dr.Kamonpan Boonkit, Asst.Prof.Dr.Piyaporn Tunneekul, Ms.Duangjit Sukhapabsuk, Mr.Surachai Yusuk, Mr.Nupong Phusri		
<b>Dec 28<sup>th</sup>, 2017</b>		
<b>Time</b>	<b>Code</b>	<b>Title</b>
14.00 - 14.15	HUM 5	<b>Developing Intrinsic Reward System in Digital Era of Chandrakasem Rajabhat University: Discursive Practice to Social Reproduction</b> by Chonticha Tippratun
14.15 - 14.30	HUM 6	<b>Lifestyles of Gen Y Men Consumer that Influenced the Loyalty of Fashion Products in Thailand</b> by Thatchavong Julawat, Sutasinee Siripokapiroma
14.30 - 14.45	HUM 7	<b>The Effectiveness of Public Policy Implementation for the Repayment Management Model to Student Loans Fund</b> by Opad Meechao

<b>PAITON (Fl.33)</b>		
<b>Session: Humanities and Social Sciences</b>		
<b>Session Chair:</b> Prof.Dr.Budsaba Kanoksilapatham, Assoc.Prof.Sita Yiemkunttavorn, Assoc.Prof.Singhanat Nomnian, Asst.Prof.Dr.Pragasit Sitthitikul, Asst.Prof.Dr.Usa Noytim, Asst.Prof.Dr.Kamonpan Boonkit, Asst.Prof.Dr.Piyaporn Tunneekul, Ms.Duangjit Sukhapabsuk, Mr.Surachai Yusuk, Mr.Nupong Phusri		
<b>Dec 29<sup>th</sup>, 2017</b>		
<b>Time</b>	<b>Code</b>	<b>Title</b>
09.00 - 09.15	HUM 8	<b>Reticent Factors of Thai EFL Students: a Case Study of Undergraduate Students in Faculty of Education, Phuket Rajabhat University</b> by Thanawan Kongkaw, Salaiya Hankhiew, Pratchaya Chuayjaroen, Sofiya Che-ousen, and Yawahir Dolah
09.15 - 09.30	HUM 9	<b>Service Areas of Social Studies Program, Faculty of Humanities and Social Sciences, Nakhon Pathom Rajabhat University</b> by Jitrapon Soontorn
09.30 - 09.45	HUM 10	<b>Relationships between Accounting Practices and Financial Strengths of SMEs: Reflections from Financial and Accounting Experts</b> by Supanee Injun
09.45 - 10.00	HUM 11	<b>The Academic and Vocational Service Model of Institute Vocational Education of Bangkok in Thailand</b> by Chantana Potikruprasert, Pariyaporn Tungkunan
10.00 - 10.15	HUM 12	<b>The Path Analysis of Factors Affecting Decision Making Behavior and Work Behavior of Employees in Large Sub-district Administrative Organization in Udon Thani Province, Thailand</b> by Khanisara Thanyasunthornsakun, Sawitree Boonmee, Rachata Suansawat and Pariyakron Wunnakeeree
10.15 - 10.30	HUM 13	<b>Factors Affecting the Organizational Engagement of Employees of the Bank for Agriculture and Agricultural Cooperatives (BAAC), Udon Thani Province</b> by Rachata Suansawat, Khanisara Thanyasunthornsakun, Sawitree Boonmee and Mathurin Kaewsangon
10.30 - 10.45	HUM 14	<b>The Effects of ZPD Based Scaffolding Techniques on Reading Comprehension of Thai University Students</b> by Surachai Yusuk

# **Poster Presentation Program**

<b>PETCH PAILIN ROOM (Fl.11)</b>		
<b>Session: Pure and Applied Science</b>		
<b>Session Chair: Assoc. Prof. Dr. Jakrapong Kaewkhao, Dr. Patarawagee Yasaka and Dr. Kitipun Boon-in</b>		
<b>Dec 29<sup>th</sup> 2017</b>		
<b>Time</b>	<b>Code</b>	<b>Title</b>
10.00 - 10.15	SCI 1 P	<b>Diversity of Culinary Herbs and Ethnobotany in Hlawga Wildlife Park, Yangon City, Republic of the Union of Myanmar</b> by Peangjai Jianwichayakul, Soe Soe Aung, Thanda Aye, Mya Zarli, Aye Aye Mu and Zin Mar Myint
	SCI 2 P	<b>Comparison of Radiation Interaction of Clay and Autoclaved Aerated Concrete Bricks for Radiation Shielding Properties</b> by Kittipong Siengsanoh, Pruittipol Limkitjaroenporn and Jakrapong Kaewkhao

<b>PETCH PAILIN ROOM (Fl.11)</b>		
<b>Session: Medical Health Sciences and Laws</b>		
<b>Session Chair: Dr. Orapun Metadilokul, Dr. Prasutr Thavornchaisit and Mr. Pornchai Eiamsettakul</b>		
<b>Dec 28<sup>th</sup> 2017</b>		
<b>Time</b>	<b>Code</b>	<b>Title</b>
15.00 - 15.15	MED 1 P	<b>Stress Relieving of Thai Traditional Medicine Students by using Thai Traditional Medicine</b> by Pitchayapa Attanoruk, Pitchayapha Inphrom, Jatuporn Panusnothai, Nantiya Manhmay and Sittipong Pornprasit.
	MED 2 P	<b>Factors Related to Mosquito-Borne Diseases in China-Laos Border Areas: Results from Multiple Correspondence Analysis</b> by Chao Wu, Hongning Zhou Jun Zhao, Xiaofang Guo, Quan Lv, Hongbin Li, Edward B McNeil and Virasakdi Chongsuvivatwong
	MED 3 P	<b>Formulation an Analgesic Spray Containing <i>Cleome viscosa</i> L. crude Extract</b> by Peerasa Ariyavechakul, Pилanthana Lertsatitthanakorn, Kongtana Trakarnsanga and Thien Thiraworawong <sup>4</sup>
	MED 5 P	<b>Antibacterial Activity of <i>Rafflesia kerrii</i> Meijer Extracts against Hospital Isolates of Methicillin-Resistant <i>Staphylococcus Aureus</i> (MRSA)</b> by Pitsanee Wichantuk, Pornphan Diraphat, Fuangfa Utrarachkij, Marut Tangwattanachuleeporn and Chakrit Hirunpetcharat
	MED 6 P	<b>Effect of Methotrexate on Interleukin-36<math>\gamma</math> serum levels in psoriasis: A pilot study</b> by Attawut Limsaengrat, Jitlada Meephansan and Achara Phumyen
	MED 7 P	<b>Stability Study of Prasaplai Capsule used for Clinical Efficacy Study in Postpartum Rehabilitation in Bang Pa In Hospital, Phra Nakhon Si Ayutthaya</b> by Chaisak Thanonkaew <sup>1</sup> , Lertchai Jitsaeree, Suwanna Pahasachalak, Suthima Sukreeket, Jiraporn Muangpran, Supaporn Pornpinatepong, Bunleu Sungthong and Pилanthana Lertsatitthanakorn

<b>PETCH PAILIN ROOM (Fl. 11)</b>		
<b>Session: Nursing</b>		
<b>Session Chair:</b> Assist. Prof. Dr. Hathaichanok Buajaroen, Assist. Prof. Dr.Pimsupa Shandanasotthi, Mrs. Natthaya Cherngchalard Chooprom, Asst.Prof.Dr. Theeranan Wannasiri, Ms.Laarnie D. Esteban, Ms.Labmie Lynnette Dematoque, Mrs. Ruffel Joy C. Manalo		
<b>Dec 28<sup>th</sup>, 2017</b>		
<b>Time</b>	<b>Code</b>	<b>Title</b>
15.00 – 15.15	NUR 1 P	<b>Health Literacy of Cambodian Transnational Workers in Nakhon Ratchasima Province via Social Media Online</b> by Dussadee Triyawong, Chatthong Jarupisitpaiboon, Nattineeporn Chantaranonthai, Narumon Premmasawat and Areerat Pesungnoen
	NUR 2 P	<b>The Effect of Empowerment Program on Self-Care Behaviour of Elderly People with Hypertension at Nakhon Ratchasima Province, Thailand</b> by Kornkan Phuengnam RN, M.N.S and Watcharee Sangsai RN, M.N.S
15.00 – 15.15	NUR 3 P	<b>Effects of Education to prevent Non-Communicable Diseases by using KORAT Song on the Knowledge and Self-Care Behaviors among Adults</b> by Kanyapat Niyomsat, Chatchai Daengdi ,Kornkanok Kabkhoontod, Kawinna Kaeophimai, Jugkapan Wanpugdee, Jutamas Saichan, Supaporn Chobsa-ard and Supawan Pongpanna
	NUR 4 P	<b>The Humanized Care Behaviors among Nursing Students Studying at Boromarajonani Nursing College, Thailand</b> by Thassanee Thipsungnoen, and Praphaphorn Suemram

<b>PETCH PAILIN ROOM (Fl.11)</b>		
<b>Session: Humanities and Social Sciences</b>		
<b>Session Chair:</b> Assist. Prof. Dr. Budsaba Kanoksilapatham, Assoc. Prof Dr. Sita Yiemkuntitavorn, Assoc. Prof. Dr. Singhanat Nomnian, Assist. Prof. Dr. Pragasit Sitthitikul, Assist. Prof. Dr. Usa Noytim, Assist. Prof. Dr. Kamonpan Boonkit, Assist. Prof. Dr. Piyaporn Tunneekul, Ms. Duangjit Sukhapabsuk, Mr. Surachai Yusuk and Mr. Nupong Phusri		
<b>Dec 28<sup>th</sup> 2017</b>		
<b>Time</b>	<b>Code</b>	<b>Title</b>
15.00 - 15.15	HUM 1 P	<b>Work Motivation of Myanmar Workers in the Food Processing Factory: Case Study of Kasemchai Farm Group Co., Ltd.</b> by Bencharat Buengboran, Assanee Piancharoenwong and Wisit Rittiboonchai.
	HUM 2 P	<b>Factors Affecting Work Efficiency of Employees of Nong Pho Ratchaburi Dairy Co-operative Limited (Under the Royal Patronage)</b> by Phuthai Saengchan, Darin Photangtham and Wisit Rittiboonchai.
	HUM 3 P	<b>The philosophy of sufficiency economy to happiness in the work of the staff in Bangkok</b> by Wisit Rittiboonchai.
	HUM 4 P	<b>Factors Affecting Employee good organizational Behavior Thai Sugar Industry Co., Ltd.</b> by Saowaluk Phetpankan, Wisit Rittiboonchai, Surasaek Phonghanyudh and Kaewta Poopatanapong.

<b>PETCH PAILIN ROOM (Fl.11)</b>		
<b>Session: Humanities and Social Sciences</b>		
<b>Session Chair:</b> Assist. Prof. Dr. Budsaba Kanoksilapatham, Assoc. Prof Dr. Sita Yiemkuntitavorn, Assoc. Prof. Dr. Singhanat Nomnian, Assist. Prof. Dr. Pragasit Sitthitikul, Assist. Prof. Dr. Usa Noytim, Assist. Prof. Dr. Kamonpan Boonkit, Assist. Prof. Dr. Piyaporn Tunneekul, Ms. Duangjit Sukhapabsuk, Mr. Surachai Yusuk and Mr. Nupong Phusri		
<b>Dec 28<sup>th</sup> 2017</b>		
<b>Time</b>	<b>Code</b>	<b>Title</b>
15.00 - 15.15	HUM 5 P	<b>Human Service System of Issues &amp; Tasks with South Korea: Effect on Quality of Human Life</b> by Misook Cho
	HUM 6 P	<b>A Study on the Behavior Problem of Poor Grandparenting Children in South Korea</b> by Misook Cho.
	HUM 7 P	<b>An Exploration of Science Student Teachers' Understanding of STEM Approach and Teaching Practices During Professional Teaching Practices</b> by Pinthudit Klinkajorn, Mattanee Siengsanoh and Kittipong Siengsanoh.
	HUM 8 P	<b>The Marketing Mix Factors affecting Selection Credit of the Government Savings Bank Kui Buri, Prachuap Khiri Khan Province</b> by Matinee Sudthum, Hansa Klaychanpong and Wisit Rittiboonchai.
	HUM 9 P	<b>Community Welfare: Welfare with a Cultural Background</b> by Jirachaya Jeawkok, Wanchai Dhammasaccakarn, Kasetchai Laeheem and Preedee Shoteshong.

<b>PETCH PAILIN ROOM (Fl.11)</b>		
<b>Session: Water Engineering, Groundwater Hydrology and Environmental Science</b>		
<b>Session Chair:</b> Assoc. Prof. Dr. Tuantan Kitpaisalsakul , Assist. Prof. Dr. Phatcharasak Arlai, Assoc. Prof. Dr. Sayam Aroonsrimorakot		
<b>Dec 28<sup>th</sup> 2017</b>		
<b>Time</b>	<b>Code</b>	<b>Title</b>
15.00 – 15.15	WRE 1 P	<b>Development of Indicators for the Assessment of Social, Economic and Environmental Impacts of Clean Development Mechanism (CDM) Projects in Pakistan with a Case Analysis of Pakistan's First Approved CDM Project</b> by Butt, Ayesha Aftab

<b>PETCH PAILIN ROOM (Fl.11)</b>		
<b>Session: The Interdisciplinary Research</b>		
<b>Session Chair:</b> Prof. Dr. med. Yongyudh Vajaradul, Dr. Waret Veerasai, Assoc. Prof. Dr. Wongchan Wongkaew, and Assist. Prof. Dr. Lertsiri Bovornkitti		
<b>Dec 28<sup>th</sup> 2017</b>		
<b>Time</b>	<b>Code</b>	<b>Title</b>
15.00 – 15.15	ITR 1 P	<b>Utilization of Pretreated Peanut Hulls for The Optimized Bioproduction of Cellulase by Pycnoporus Sanguineous</b> by Methus Chuwech, Nuansri Rakariyatham, Kawin Supawittayayothin, Niphorada Yawirat, Nopakarn Chandet , Jidapha Tinoi and Phakhawat Jaisin

## Table of Contents

	Page
Plenary Abstract	Page
<b>Proceedings</b>	i
<b>Session of Sustainable Development Goals (SDGs)</b>	SDG 1
Peaceful and nonviolent societies as a sustainable development goal 16	SDG 2
UNESCO Global Geoparks: A new management tools for sustainable development and Satun Aspiring UNESCO Global Geopark	SDG 8
Managing Sustainable Development	SDG 17
Promoting sustainable development goals through Corporate Social Responsibility (CSR) Practices: Cases of rural hotels in Bali, Indonesia	SDG 22
<b>Session of Pure and Applied Science</b>	SCI 1
Diversity of birds in Hlawga Nature Park Republic of the Union of Myanmar	SCI 2
Diversity of Culinary Herbs and Ethnobotany in Hlawga Wildlife Park, Yangon City, Republic of the Union of Myanmar	SCI 10
Comparison of Radiation Interaction of Clay and Autoclaved Aerated Concrete Bricks for Radiation Shielding Properties	SCI 18
A negative binomial- new weighted Lindley distribution for count data and its application to hospitalized patients with diabetes at Ratchaburi hospital, Thailand	SCI 25
<b>Session of Electrical Engineering and Technology</b>	EET 1
Investigating Electric Vehicle (EV) charging station locations for Agartala, India	EET 2
Effect of Weather Change on Hydrogen Production via Electrolysis Powered by Photovoltaic System	EET 14
Power Loss Comparison of Pulse Width Modulation Techniques Based on Space Vector Method by MATLAB/SIMULINK	EET 22
<b>Session of Computer and Information Technology</b>	COM 1
Ontology-based multi-agent systems: an overview of existing approaches	COM 2
Evaluation of Linux I/O Schedulers of HDFS on SSD	COM 12
Social media framework incorporating Fuzzy regression for affective design: state-of-the-art, challenges, and opportunities.	COM 19

Service measurement tool for Internet Service Provider	COM	28
Semantic Web-based Approach for Economic Performance Indicators Based on Global Reporting Initiative (GRI) G4	COM	36
A Multi-agent Approach for Semantic Annotation of Source Code Artefact	COM	53
<b>Session of Medical Health Sciences and Laws</b>	MED	1
Stress relieving of Thai Traditional Medicine students by using Thai Traditional Medicine	MED	2
Factors Related to Mosquito-Borne Diseases in China-Lao Border Areas: Results from Multiple Correspondence Analysis	MED	8
Effect of Methotrexate on interleukin-36 $\gamma$ serum levels in psoriasis: A pilot study	MED	17
Formulation an Analgesic Spray containing Cleome Viscosa L. crude Extract	MED	21
Influence of astaxanthin on the elicitation of allergic contact dermatitis to p-phenylenediamine: A pilot study	MED	29
Efficacy of combining fractional carbon dioxide laser and silicone gel in treatment of hypertrophic scars and keloids	MED	37
Stability Study of Prasapalai Capsule used for Clinical Efficacy Study in Postpartum Rehabilitation in Bang Pa In Hospital, PhraNakhon Si Ayutthaya	MED	43
Effect of calcipotriol on UVB-induced MMP-9 in human skin: A pilot study	MED	49
<b>Session of Nursing</b>	NUR	1
The Humanized Care Behaviors among Nursing Students Studying at Boromarajonani Nursing College,Thailand	NUR	2
Health literacy of Cambodian transnational workers in Nakhon Ratchasima province via social media online	NUR	9
The Effect of Empowerment Program on Self-Care Behaviour of Elderly People with Hypertension at Nakhon Ratchasima Province, Thailand	NUR	16
Effects of teaching with KORAT song on knowledge and self-care behaviors in prevention of non-communicable diseases among adults	NUR	21
<b>Session of Humanities and Social Sciences</b>	HUM	1
The Impact of Perceived Transformational Leadership on Perceived	HUM	2



Employee Creativity in Orchid Farming in Nakhon Pathom Province		
Determinants of Happiness in a Multicultural Setting: A Case of Chana district, Songkhla province, Thailand	HUM	6
The Comparative Study of Logistics Cost Structure for Farmers' Siamese Fighting fish	HUM	12
Developing Intrinsic Reward System in Digital Era of Chandrakasem Rajabhat University: Discursive Practice to Social Reproduction	HUM	16
The Academic and Vocational Service Model of Institute Vocational Education of Bangkok in Thailand	HUM	23
Community welfare: welfare with a cultural background	HUM	30
An Exploration of Science Student Teachers' Understanding of STEM Approach and Teaching Practices During Professional Teaching Practices	HUM	38
Factors Affecting Work Efficiency of Employees of Nong Pho Ratchaburi Dairy Co-operative Limited (Under the Royal Patronage)	HUM	42
The Effectiveness of Public Policy Implementation for the Repayment Management Model to Student Loans fund	HUM	51
Work Motivation of Myanmar Workers in the Food Processing Factory: Case Study of Kasemchai Farm Group Co., Ltd.	HUM	59
The philosophy of sufficiency economy to happiness in the work of the staff in Bangkok	HUM	65
The marketing mix factors affecting selection credit of the government savings bank kui buri, Prachuap Khiri Khan province	HUM	72
Service Areas of Social Studies Program, Faculty of Humanities and Social Sciences, Nakhon Pathom Rajabhat University	HUM	78
Reticent factors of Thai EFL students: a case study of undergraduate students in faculty of education, Phuket Rajabhat University	HUM	84
<b>Session of Water Engineering, Groundwater Hydrology and Environmental Science</b>	WRE	1
The potential solutions of water resource problem in Cisarua Sub-district, Bogor, West Java, Indonesia	WRE	2
Development of indicators for the assessment of social, economic and environmental impacts of clean development mechanism (CDM) projects in Pakistan with a case analysis of Pakistan's first approved CDM project	WRE	12
Comparison data inventory of two limestone quarries with	WRE	22

environmental footprint technique

**Session of Hospitality and Tourism Management**

TOUR 1

Comparing performance of centralized and non-centralized safety  
Stock Case Study: Retail Clothing Business

TOUR 2

Guidelines for Community Participation in the Woven Fabric  
Conservation for Cultural Tourism in Phai Hu Change Community in  
Banglane District, Nakhon Pathom Province

TOUR 8

The Guidelines for Public Relations and Tourism Promotion of  
the Wat Tha Phut Folk Museum, Rai Khing Subdistrict, Sam Phran  
District, Nakhon Pathom Province

TOUR 14

**Session of the Interdisciplinary Research**

ITR 1

Utilization of pretreated peanut hulls for the optimized bioproduction  
of cellulase by *Pycnoporus Sanguineus*

ITR 2

# **Plenary Abstracts**

# Flood Disasters and their Mitigation in the Wake of Climate Change with a Focus on Thailand Case Studies

M. Koch<sup>1,\*</sup>

<sup>1</sup>Department of Geotechnology and Geohydraulics, University of Kassel, Germany

## Abstract

Floods belong to the class of so-called hydrological disasters that include, in addition, landslides and extreme ocean waves. As such they are largely triggered by extreme meteorological/climatic events which includes storms and tropical cyclones, and on the other extreme, droughts and extreme temperatures. Because of these different possible origins of floods, it is of no surprise that recent climate change across the world has - and may have more so in the future - noticeable effects on the occurrence of floods, however, depending much on the locality of the region. Notwithstanding of numerous climate research studies carried out over recent years which unequivocally predict large temperature increase across the globe over the 21<sup>st</sup> century, the alterations of regional rainfall pattern to a more extreme behavior, which eventually would lead to more and stronger flood events, is less clear and continues to be an ongoing topic of discussion and research. Thus, although increasing temperatures are likely to lead to increasing precipitation, the effects on extreme storms are less clear. The situation is more straightforward for low-lying coastal areas, as rising sea levels in the wake of climate change will irrevocably lead to higher flood stages there.

Specifically, the year 2017, now coming to an end, has seen some huge flood disasters in various regions of the world, i.e. in Texas and Florida, both triggered by hurricanes (Harvey and Irma, respectively), South Asia (India and Bangladesh) and Southeast Asia (Malaysia, Thailand), triggered here by extended seasonal Monsoon precipitation which turned out to be stronger than normal. Indeed, as far as Southeast Asia, i.e. Thailand, is concerned, flood events appear to have been more numerous over the last few years. Again, whether this is another manifestation of climate change in the region, or just a consequence of some intermittent multi-annual or decadal variability of well-known Pacific atmospheric/oceanic indices, i.e. ENSO / El Niño-SST, which are known to strongly affect the seasonal weather pattern in the circum-Pacific coastal regions, is still a matter of debate. In fact, studies of the author show indeed strong correlative seasonally delayed tele-connections between ENSO / El Niño indices and Thailand's local weather pattern.

As large flood disasters cause huge economic losses, let alone losses of lives, - and weather extremes are impossible to be stopped or controlled -, flood mitigation or flood control becomes an urgent necessity for all stakeholders involved. In the short term, early warning systems including improved weather- and/or tropical storm track prediction, may be helpful to, at least, save human damages from subsequent flood events. However, for a successful long-term flood mitigation, an integrated flood management or control is necessary, which includes the preparation of flood-prone areal maps through observations or hydraulic modeling, reservation of flood diversion areas, construction of levees, and in central Thailand river basins, appropriate water management in the upstream reservoir/dams. Last, but not to the least, overland runoff processes should be slowed down by environmentally friendly land-use management, such as reforestation of denuded lands, or at least the cease of deforestation activities, as they have been ongoing in many natural scenic landscapes and national parks of Thailand over the last decades.

**Keywords:** Floods, climate change, extreme events, storms, hemispheric atmospheric/ocean indices, ENSO, flood mitigation, hydraulic modeling

---

\* Corresponding author; e-mail: kochm@uni-kassel.de

# **Session of Sustainable Development Goals**

# Peaceful and Nonviolent Societies as a Sustainable Development Goal 16

Ingrida Grigaitytė<sup>1,\*</sup> and Hasan Habes<sup>1</sup>

<sup>1</sup>Peace, Mediation & Conflict Research, Faculty of Education and Welfare Studies,  
Åbo Akademi University, Strangatan 2, 65100, Vaasa, Finland

## Abstract

In the light of the UN Sustainable Development Goals, there is a growing need for approaches, tools, policies and practical solutions for peaceful, just and strong societies in today's multicultural community. This paper describes a model of a peaceful society within the Närpes community in Finland by employing ethnographic participant observations and semi-structured interviews. In 2016, the ethnographic data were gathered during different occasions via the acquaintance networks and seven interviews were conducted with the experts of the areas of interest for the purpose of this research. The Närpes Model comprehends five elements; (1) the ethnic identities of the Närpes inhabitants, (2) the values of the Närpes society, (3) Närpesians' relation to the foreign cultures, (4) socioeconomic equality and stability, and (5) tight interaction among different sectors and institutions. This holistic Närpes approach reveals that promotion of peace and justice along with apprise of peoples' identities and values, positive interaction among different ethnic groups, and creation of effective and accountable institutions can make the world to be a better place. It is possible to have a peaceful and nonviolent society as in the example of Närpes model. Although Närpes is a small-scale community, the approach to achieve peace, justice and strong institution can be applied to broader societies to fulfill the challenges of extremely multicultural communities. Thus, the SDG 16 is one of the global goals, which is possible to reach worldwide by 2030, if the action is taken now.

**Keywords:** Peaceful Societies, Nonviolent Societies, Närpes model, The UN Sustainable Development Goals.

## 1. Introduction

The official end of the Millennium Development Goals in 2015 brings the world to the new era of the Sustainable Development Goals (SDGs) [1]. With the SDGs, the implementation of the goals become universal since the goals focus not only on the developing countries, but also on the developed countries to take action to provide a sustainable planet for the future generations. In order to end poverty, protect the planet, and assure people living in peace and prosperity, these 17 goals are adopted by the countries having priorities on climate change, economic inequality, sustainable consumptions, innovations, and peace and justice [2].

Although all 17 goals have different aims and targets, they are all interconnected. In order to reach the targets set out in the SDGs, the fundamental issue is to work on the goals collectively and interdependently. In this respect, not only governments but also private sectors, civil societies and citizens need to work together in order to achieve the SDGs.

Turning plans into actions and promises into reality as foreseen in the SDGs is not something that impossible to achieve, if all nations work together collaboratively. Authors of this paper focus on the SDG 16, which is promoting peace and justice with building effective and transparent institutions. This aims to create peaceful, nonviolent and sustainable societies. In this regard, the unique case of Närpes, an exceptionally peaceful community on the west coast of Finland, can be seen as an example of how to implement these goals in practice. For that reason, Närpes as a model of peaceful society that is achieving Goal 16 in the SDGs will be discussed in this paper

Närpes is a small Swedish-speaking town in South Ostrobothnia region that became well-known for its peacefulness, multiculturalism, successful integration and cohesion among the inhabitants, and very low levels of violence and crime. In 2016, approximately thirty-five different nationalities (11% of all population), with over fifteen spoken languages, reside within a community of 9387 inhabitants [3]. However, foreign population is not exactly presented in the statistical database. First, only those persons that have an A-status for staying in the country are officially registered. Second, people that acquired Finnish passports are totaled as Finnish nationals [4].

---

\* Corresponding author; e-mail: [igrigait@abo.fi](mailto:igrigait@abo.fi)

**Table 1: Närpes Population Based on the Language Background**

	Total	Finnish speakers	Swedish speakers	Other languages
	<b>9387</b>	<b>523</b>	<b>7 747</b>	<b>1 117</b>
Men	<b>4 750</b>	<b>210</b>	<b>3 951</b>	<b>589</b>
Women	<b>4 637</b>	<b>313</b>	<b>3 796</b>	<b>528</b>

Beside the metropolitan cities, Närpes was the first community that received refugees in Finland [5]. In 1988, the first Vietnamese came; in 1992, the first Bosnians arrived, in 2004 followed by labor immigration from the other Balkan countries, Eastern Europe, Central America, and in 2014 refugees from Sudan [6]. During the past year, fluctuating number of the asylum seekers and refugees from mainly Middle East reside in Närpes [7],[8].

Based on the collected statistics from the year 2010 to 2013, out of the 304 municipalities, Närpes was ranked the 11th safest place to live in Finland [9]. In 1995, the only case of homicide since 1980 took place. It was an incident caused due to the jealousy and drinking problems when a husband murdered his wife. Between the year 2000 and 2015 July, only 23 aggravated assaults were recorded [10]. Närpesians themselves feel safe in this community and are not afraid to walk in the streets in the dark. Local people say that it is quite and safe in Närpes; “our children can go to and from school unaccompanied and play safely in the parks and close by the forests”. At the moment, Närpes municipality does not have any police station. For couple of years, a police establishment in Närpes was operating twice a week as a service station, which was totally closed in the beginning of 2016 [11],[12]. In addition, recent research that looked at a drug use for the depression, need for child protection, allowances given due to the sickness, and crimes influenced by alcohol or drugs found out that out of 317 municipalities, Närpes is the 5th happiest municipality in Finland [13].

## 2. Materials and Method

In order to get the insights on the social relations between the locals and immigrants of Närpes as well as to understand the work of institutions, two complementary methodologies were employed: ethnographic participant observations and semi-structured interviews.

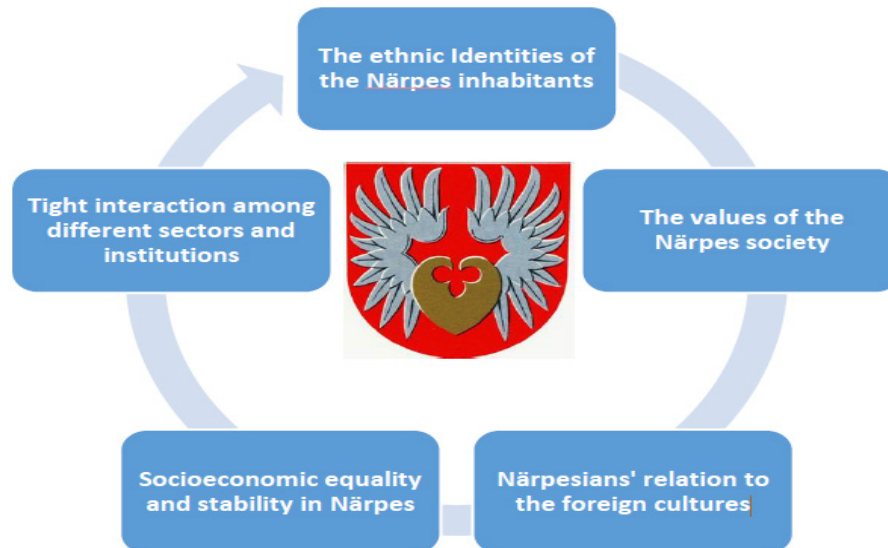
Ethnographic participant observations have been conducted since 2016. The data related to Närpes culture, its peacefulness, and Närpesians’ nonviolent behavior have been gathered and recorded, by talking with people on daily basis, and by going on the visits and attending social gatherings. Thus, it has been a possibility to conduct ethnographic observations on different occasions via the acquaintance networks. These observations were recorded on a paper in a notebook providing a commentary on the happening, interactions, and behavior of the observed people.

In 2016, semi-structured interviews were carried out with seven participants. These participants were selected via acquaintance networks based on their knowledge and familiarity of interest areas of a researcher; a 56-year-old lady that works as an integration coordinator of a Welcome office, a 74-year-old chairwoman of Närpesnejdens fredsförening [Närpes Peace Civil Society], a 37-year-old chairwoman of Ljusets kvinnor [Women of Light CSO], a 77-year-old man that worked as a primary school teacher with the first Vietnamese and Bosnian refugee kids, a 33-year-old service lady at the local employment office, a 46-year-old language and culture teacher at the local Adult Education Center, and a 27-year-old lady working as a Islam religion teacher at the local high school. Emerging themes for the interviews focused on the social cohesion, daily lives, integration processes within the community, people's behavior, and culture of a Närpes society. Prior to the interview session, interviewees were informed about the topics of the interview, rights of an interviewee, usage of the material, practical issues related to the interview session and so forth. One interview took place at the respondent’s workplace and the remaining five at the respondents’ homes. Interviews were conducted in Swedish and approximately took one hour. The interviews were audio recorded, indexed by general topic, and transcribed into electronic form using a word processor.

### 3. Results and Discussion

The Närpes model comprehends the five following components: (1) the ethnic identities of the Närpes inhabitants, (2) the values of the Närpes society, (3) Närpesians' relation to the foreign cultures, (4) socioeconomic equality and stability, and (5) tight interaction among different sectors and institutions.

**Figure 1: Närpes Model**



#### The ethnic identities of the Närpes inhabitants

In Finland, Swedish community faces culture survival challenges but yet people of Närpes are proud of their strong unique culture deriving from the local traditions and traditions brought up by the immigrants. Närpesians themselves are not true Finns or Swedes and they cannot either be purely classified under the Swedish-speaking Finn culture either due to their strong Swedish dialect or due to a great mix of cultures residing with the community.

Närpesians are a minority within the minority Swedish population among the major Finnish population. They know how it feels to be an ethnic minority within the major culture and so it is relatively easy to sympathise with the town foreigners. Especially, the younger Närpesian generation are more open to the diversity and has more willingness to create cross-cutting ties among the locals and foreigners. They tend to be less religious than their parents, they have received degrees of higher education, they have experienced working or studying abroad, and their background is a rich blend of various cultures. It is a growing phenomenon that while growing up, a child speaks three or four languages as well as encounters traditions and behavior patterns of several ethnic groups. For instance, a mother speaks Swedish to a child, a father speaks Dutch, between each other parents speak English, and a child is attending Finnish speaking school. This creation of multicultural identities have been present in Närpes for several decades, and it is one of the factors contributing to Närpesians' pragmatic openness towards the other ethnic groups.

#### The values of the Närpes society

The old Närpesian values owe to both, Swedish and Finnish cultures. The main characteristic of the Finns is their sameness; they do not like to stand out from the crowd and they mode of dress is very similar to everyone else's. Finns do not celebrate their achievements since it would be seen as bragging. They are naturally reserved, especially towards the chatty foreigners, and are likely to seem very formal and aloof. Meanwhile Swedes, are open-minded, social, and chatty in contrast to the Finns. Swedes value personal equality, they are liberal even though they are moderate and do live their cultural lives based on traditions, stability, and customs. In both cultures, there is a relative absence of social barriers – no class distinctions in education and everyday social life that minimize the gaps between the racial, social, or class superiority. Little town of Närpes, when compared to Scandinavia, has long and extensive experience of immigration, which brought up an equal society based on diversity. One of the local teachers says that “we all can be equal even though we all cannot be the same”. Närpesians value people and the strongest values noticed within their community are honesty, equality,



humbleness, modesty, privacy, calmness, directness, and integrity. Also, it is very important to obey the rules, which is also their moral and ethical code. Immigrants of Närpes see locals as civilized, calm, independent, autonomous, and silent people. But if they overcome embarrassment speaking out loudly in public, then they say what they mean and mean what they say. Immigrant people of the Närpes community often say that Finns can be shy as well as suspicious towards the strangers but they are very honest and loyal once you make friends with them.

### **Närpesians' relation to the foreign cultures**

Närpes people's relation to the foreign culture has much to do with about a century long embedded tradition of emigration and immigration. The first migration wave to the US took place in the beginning of the 20th century and during the 1960s and 1970s people migrated for the employment and education opportunities to Sweden, other Nordic countries, and bilingual towns in Finland. When it comes to immigration to the town of Närpes, it has a 29-year-long tradition of integration. In 1988, Närpes was the first Swedish-speaking municipality in Finland that received quota refugees from Vietnam followed by the Balkan countries. Later on, employment based migration from the Baltic countries, Russia, Ukraine, Belarus, Poland, Ecuador, and the Netherlands, just to name view, took place. Thus, marriage based migration brought to town people with Thai, Moroccan, or Slavic backgrounds. At the moment, Närpes municipality is offering resident places to the current quota refugees and asylum seekers. This exchange of interaction between locals and foreigners keeps on continuing. Today, it is relevantly easy for the immigrants to come to Närpes since they already have family members or friends who explored the town before them; they already know what to expect and thus, a newcomer does not have to feel alone or lonely since there are others who have similar cultural background and reasons for immigrating. Occasionally, locals and foreigners might be xenophobic, however, this does not last long since within the small scale community as Närpes is, people get to know each other fast, they interact daily, and so differences start to be seen as advantages for shaping a multicultural community.

### **Socioeconomic equality and stability in Närpes**

Finns and people from the Ostrobothnia region are known as hardworking and have deep-rooted entrepreneurial skills. This is shown in the high levels of work sufficiency and low levels of unemployment (4% unemployment), lowest in the country (13% in all Finland) [14]. In Närpes, economic situation started to progress during the past decades. During the middle of the twentieth century a large proportion of the working age Närpesians emigrated leading to unbalanced age structure. In the beginning of the twentieth first century, there was a big need for a labor force, therefore, immigration from abroad successfully met labor demands. At the moment, labor immigration is more intense than it has been ten years ago and this balances widespread emigration, especially among the youth, due to which labor needs within the sectors of agriculture, healthcare, and metal industries had emerged. These labor immigrants become employed taxpayers that occupy vacant and create new working places as well as they inspire and develop entrepreneurship. Since labor force has increased, entrepreneurs were also able to expand their businesses. Small family-based firms became well-developed companies.

Education, which is a big part of successful integration planning, also gave opportunity to town foreigners to become well-known entrepreneurs, politicians, restaurant owners, photographers, academics, and respected people not only in Närpes but also elsewhere. Immigrants agree that steady income and education is an important factor for their well-being, life quality as well as it allows them to plan their own economy and the future. This financial security also allows raising children that has opportunities to free education, healthcare, and a future in Närpes. Närpes municipality pays a great attention to education for both, adults and children. Immigrant adults can participate in language and culture courses and for immigrant children there are arranged lecturing in native language that could strengthen multicultural identity and create functional bilingualism. This positive inflow of international migration that balanced age structure allowed Närpes to become a transparent society that has transformed from emigration to immigration rural countryside.

### **Tight interaction among different sectors and institutions**

People from Närpes region are known to be as self-assertive and noblest. Day to day life affairs are handled in a tight, smooth, and client oriented manner through dialogue and communication. Within the small scale community such Närpes, errands are fixed based on a close communication between the community inhabitants, immigrants, companies, authorities, and the third sector. For instance, employers actively facilitate integration, employment office or social care services relatively easily can direct people to acquire suitable housing or schooling. People are usually aware of happenings within the community and they are quick to react to any potential problems, issues, and needs. It is relatively easy to communicate and solve problems in a small town with people you know, and so a positive circle of successful actions that manage diversity are created. A

work of a third sector, which is various CSOs, associations, non-profit organizations, and clubs means a lot to Närpes community and their identity. In Närpes, there are 108 registered associations and their networks are connected to traditions, native regions, cultural manifestations and language, as well as they provide a great number of meeting places, which is especially important to the minority. The life of a third sector also has an immense meaning in creating more coherent and interdependent society; it keeps people of different ages and cultural backgrounds active and interactive and it improves relationships and communication within and among Närpes inhabitants.

#### 4. Conclusion

There are many challenges and threats in achieving the targeted UN Global Goals worldwide. However, in the light of our case study, the Närpes model exhibits possibilities for peaceful, inclusive, and nonviolent societies in today's diverse world. This paper presents a holistic example, Närpes model, which is a successful approach to implement the SDG 16 within the small-scale Swedish community in the Finnish context. In this particular case, there are five components, which complement each other to create peaceful, inclusive, and harmonic environment for Närpes inhabitants. If this model to be applied in Finland or elsewhere in the world, the following should be considered; (1) there should be a support for creation of multicultural identities in order to have a prejudice free generation; (2) the values of Närpes inhabitants are welcoming, and so long there is a mutual respect in the society, there can be a presence of positive circles of interactions; (3) exposure to the foreign cultures through migration in the forms of labor, education, or marriage allow people to relate and understand the conditions of others; (4) providing free education and equal working opportunities for all, allow people feel secure to have a positive future; (5) close communication and cooperation within different sectors and institutions allow constructive dialogue creation among the inhabitants to keep them interdependent and solve their daily concerns peacefully. This Närpes model can be used as an example to form more peaceful, inclusive and violence-free social structures within not only the small-scale communities, but also in broader parts of the world.

#### References

- [1] United Nation. Sustainable Development Goals [Internet]. [12 Aug 2017]. Available from: <http://www.un.org/sustainabledevelopment/sustainable-development-goals/>
- [2] United Nation Development Program. Sustainable Development Goals [Internet]. [15 Aug 2017]. Available from: <http://www.undp.org/content/undp/en/home/sustainable-development-goals.html>
- [3] Tilastokeskus . Befolkning 31.12. efter Landskap, Bakgrundsländ, Härkomst, År, Kön och Ålder. [23 May 2016]. Available from: [http://pxnet2.stat.fi/PXWeb/pxweb/sv/StatFin/StatFin\\_vrm\\_vaerak/055\\_vaerak\\_tau\\_124.px/table/tableViewLayout1/?rxid=611ac405-5474-4704-b002-4155dea455cc](http://pxnet2.stat.fi/PXWeb/pxweb/sv/StatFin/StatFin_vrm_vaerak/055_vaerak_tau_124.px/table/tableViewLayout1/?rxid=611ac405-5474-4704-b002-4155dea455cc)
- [4] Poliisiammattikorkeakoulu. Tutkimus ja kehittäminen [Internet]. [10 Feb 2016]. Available from: <http://www.polamk.fi/tki>
- [5] Granholm, P. (2009). Rätt invandrare till rätt plats - det närpesiska receptet för god integration. [Report]. Ålands fredsinstitut, Finland; 2009. Available from: [http://www.peace.ax/images/stories/pdf/Det\\_nrpesiska\\_receptet\\_fr\\_god\\_integration.pdf](http://www.peace.ax/images/stories/pdf/Det_nrpesiska_receptet_fr_god_integration.pdf)
- [6] Mattila, M., & Björklund K. Tomaatteja, teollisuutta ja monikulttuurisuutta, Närpiön malli maahanmuuttajien kotouttamisessa. Turku, Finland: Painosalama; 2013.
- [7] Migri. Maahanmuuttovirasto [Internet]. [2 Feb 2016]. Available from: [http://www.migri.fi/tietoa\\_virastosta/tilastot](http://www.migri.fi/tietoa_virastosta/tilastot)
- [8] Söderman, M. Nya och gamla invånare möts på café. Syd-Österbotten [Newspaper], [19 Sep 2015]. Available from: <http://www.sydin.fi/>
- [9] Syd-Österbotten. Syd-Österbotten [Newspaper]. [14 Mar 2014]. Available from: <http://www.sydin.fi/>
- [10] Kriminologian ja oikeuspolitiikan instituutti. Tutkimus [Internet]. [14 Mar 2015]. Available from: <https://www.helsinki.fi/fi/kriminologian-ja-oikeuspolitiikan-instituutti>
- [11] Nissen, D. Polisen upphör med servicen i Närpes. Syd-Österbotten [Newspaper]. [12 Jan 2016]. Available from <http://www.sydin.fi/>
- [12] Poliisi. Polisinrättningen i Österbotten [Internet]. [9 Feb 2016]. Available from: <http://www.poliisi.fi/sv/osterbotten>
- [13] Tilastokeskus. Tilastokeskus [Internet]. [17 Mar 2015]. Available from: <http://www.stat.fi/org/index.html>
- [14] Närings-, trafik- och miljöcentralen. Österbotten: sysselsättningsöversikt [Internet]. [25 Apr 2016]. Available from: <http://www.ely-keskus.fi/documents/10191/57761/ELY+POH+Ty%C3%B6llisyyskatsaus>

+2016\_04\_sv.pdf/30631184-bb7d-4169-9f30-01dbd06e61c7 maahanmuuttajien kotouttamisessa.  
Turku, Finland: Painosalama; 2013.

## UNESCO Global Geoparks : A New Management Tools for Sustainable Development and Satun Aspiring UNESCO Global Geopark

Pakkaporn Singhwachiraworakul<sup>1,\*</sup>, Pratueng Jintasakul<sup>2</sup>, Paul Grote<sup>2</sup>, Narongrit Thungprue<sup>3</sup>

<sup>1</sup>Faculty of Business Administration, Vongchavalitkul University, Nakhon Ratchasima, 30000, Thailand

<sup>2</sup>Northeastern Research Institute of Petrified Wood and Mineral Resources, Nakhon Ratchasima Rajabhat University, Nakhon Ratchasima, 30000, Thailand

<sup>3</sup>Satun Aspiring UNESCO Global Geopark, Satun Province, 91120, Thailand

### Abstract

UNESCO Global Geopark model is a new management tool for communities to manage heritages effectively and sustainably. It is one of the best practices on sustainable development regarding to protect and promote international value on geological sites. It aims to empower local communities to balance and raise awareness on how to use their heritages sustainably for the next generation. It is best management tools for local administrative organization to lead by example and manage the area from the bottom up. Instilling the locals to care and share their heritages through public education. ‘Geo’ part of Geopark recognized as everything that mother earth and our forefather have given us including geology, biodiversity, history, cultural heritages, intangible assets such as custom, belief, myths, and traditions. Geopark has been recognized by UNESCO since 2015 after 24 years of establishment. It is a part of International Geoscience and Geopark program (IGGP) as a new tools for balancing between the conservation of natural heritage, education, infrastructures and sustainable development of socio-economy. In 2017, there are 127 UNESCO Global Geoparks from 35 countries worldwide. UNESCO Global Geoparks support 8 Sustainable Development Goals of the United Nations 2030 Agenda for Sustainable Development especially for people, and planet. Thailand started the project on geopark since 2013 by learning from the Statutes and Operational Guidelines of the UNESCO Global Geopark and international experts. Satun Geopark is the 1<sup>st</sup> National Geopark with approved and nominated by Thailand’s cabinet to apply for UNESCO Global Geopark through Thai National Commission for UNESCO since 2016. It located in Southern Thailand. It has strongly supported and collaborated by many stakeholders and strategic partners including local and central organizations. After establishing geopark, new concept of tourism – geotourism has created. Communities get new opportunities such as extra income, job creation, infrastructures, new local products which related to geology and natural resources. The Petra Islands National park has new model of mutually beneficial collaboration with local communities. Local schools have materials and program for students’ outdoor learning. They can better understand their place and heritages especially fossils and geology. Nowadays, Satun Aspiring UNESCO Global Geopark has been known as Fossil Land. It is 1 of 18 submitted applications by Member States for the nominations of UNESCO Global Geoparks. Application dossier of Satun Aspiring UNESCO Global Geopark already passed the desktop evaluation, field evaluation and recommendations on applications by the UNESCO Global Geoparks Council since September 2017. The final decision by the Executive Board of UNESCO will be decided during its spring session.

**Keywords:** Geopark, Sustainable Development, UNESCO Global Geoparks, Satun Geopark, Thailand Geopark

### 1. Introduction

Geopark is one of the best sustainable development tool for protection and promotion of geological heritages internationally by local communities involvement. Geopark concept was introduced through a global network since 1991. It took 24 years until the International Geoscience and Geoparks Programme (IGGP) was approved as a programme of UNESCO on 17 November 2015. This program comprises the International Geoscience Programme (IGCP) and the UNESCO Global Geoparks aims to promote sites of international geological value on the basis of local sustainable development. In 2017, there are 127 UNESCO Global Geoparks in 35 countries, varying in size from 57 to 12,884 km<sup>2</sup>. [1] There are 49 UNESCO Global Geoparks from 6 countries in Asia-Pacific Geopark Network (APGN) including 35 areas in People Republic of China, 8 areas in Japan, 2 areas in Indonesia, 2 areas in Republic of Korea, 1 area in Vietnam and 1 area in Malaysia.[2]

\* Corresponding author; e-mail: pakkaporn\_sin@vu.ac.th

The United Nations Educational, Scientific and Cultural Organization (UNESCO) defines UNESCO Global Geoparks as “A single, unified geographical areas where sites and landscapes of international geological significance are managed with a holistic concept of protection, education and sustainable development”. [3] Many people confuse about “Geo” which is part of Geopark. It does not mean geology but it came from Greek word. Mc Keever explained that “Geo” refers to ‘Gaia’- Earth itself, and everything that Earth has given us and every way it has shaped us including geodiversity, biodiversity, cultural diversity and even the diversity of our intangible heritage are so intimately linked.” [4] Komoo and Patzak added some details that “the geopark concept is defined as one of the sustainable development tools that can ensure balance between three main elements, namely : conservation of heritage resources; development of tourism and infrastructure; and enhancement of local participation and socio-economic development”. [5]

The Geopark concept was implemented in Thailand by the Department of Mineral Resources since 2014. Satun province accepted geopark as the tool for sustainable development of the area and established the new aspiring geopark, namely Satun Aspiring Geopark. By the strongly supported of many stakeholders and partnerships including ; local communities, travel agencies, restaurants, hotels, local communities enterprises, schools, community college, universities, provincial administrative organization, subdistrict administrative organizations, Satun Office of Natural Resources and Environment, national parks, wildlife sanctuary, Department of Mineral Resources and etc., especially the experts from Global Geoparks Network (GGN), Asia Pacific Geoparks Network (APGN), and European Geoparks Network (EGN). Satun Aspiring Geopark was established since 2014 and declared as the 1<sup>st</sup> Thailand National Geopark. The application dossier for nomination as UNESCO Global Geopark of Satun Aspiring Geopark was approved by Thai cabinet and nominated to Chief of Section, IGGP Secretary of Section on Earth Sciences and Geohazards Risk Reduction via Thai National Commission for UNESCO since 2016. Satun Aspiring UNESCO Global Geopark has international significance on the richest diversity of Paleozoic fossils, international value of the region and well known globally by geologists, paleontologists and researchers. Satun Aspiring UNESCO Global Geopark is one of the best geopark model for Thailand regarding sustainable development with bottom up approach - community based development. which concern the 2030 Agenda for Sustainable Development for all people and sectors based on societal and geographical conditions.

## 2. Objective

To study the UNESCO Global Geopark concept as the new management tools for sustainable development of Satun Aspiring UNESCO Global Geopark, Thailand.

## 3. UNESCO Global Geopark

### 3.1 Geoparks’ concept and development

Geopark is the new tool aimed to protect the geological heritages and promote sustainable development. It comes from 2 words, Geo and Park. McKeever explained that “Geo” part of Geopark refers to ‘Gaia’ – Earth itself, and everything Earth has given us and every way it has shaped us. [1] Many people get confused on geopark. It does not mean the protection and conservation of geological heritages only. It was the concept which concern the protection between socio-economic, cultural development and conservation of the natural environment for the next generation.

John said that “Philosophy behind the Geopark concept was first introduced at the Digne Convention in 1991”, aimed to protect and promote geological heritage and sustainable development through a global network and it was introduced to support national and international endeavours in Earth heritage conservation in 1997. [6,7] After that, the European Geopark Network (EGN) and the Chinese National Geoparks Network (CNGN) were created in 2000 and a year later, in 2001, EGN was placed under the auspices of UNESCO. In 2004, 17 European and 8 Chinese geoparks came together at UNESCO headquarters in Paris to form the Global Geoparks Network (GGN) where geological heritage initiatives contribute to and benefit exchange and cooperation among their membership of a global network. [7] Global Geopark Network members increase year by year until 17 November 2015, the 195 Member States of UNESCO voted to accept the creation of a new label, the new official brand, the International Geoscience and Geoparks Programme (IGGP), during the 38<sup>th</sup> General Conference in Paris. Geopark is a part of IGGP, which mainly promotes sites of international geological value on the basis of local sustainable development. This expresses governmental recognition of the importance in managing outstanding geological sites and landscapes in a holistic manner. [8]

UNESCO defines UNESCO Global Geoparks as :

...a single, unified geographical area where sites and landscapes of international geological significance are managed with a holistic concept of protection, education and sustainable development. A UNESCO Global Geopark uses its geological heritage, in connection with all other aspects of the area's natural and cultural heritage, to enhance awareness and understanding of key issues facing society, such as using our earth's resources sustainably, mitigating the effects of climate change and reducing natural disasters-related risks. By raising awareness of the importance of the area's geological heritage in history and society today, UNESCO Global Geoparks give local people a sense of pride in their region and strengthen their identification with the area. The creation of innovative local enterprises, new jobs and high quality training courses is stimulated as new sources of revenue are generated through geotourism, while the geological resources of the area are protected. [9]

UNESCO Global Geoparks aims to empower local communities and give them the opportunity to develop cohesive partnerships with the common goal of promoting the area's significant geological processes, features, periods of time, historical themes linked to geology, or outstanding geological beauty. UNESCO Global Geoparks are established through a bottom-up process involving all relevant local and regional stakeholders and authorities in the area (e.g. land owners, community groups, tourism providers, indigenous people, and local organizations). This process requires firm commitment by the local communities, a strong local multiple partnership with long-term public and political support, and the development of a comprehensive strategy that will meet all of the communities' goals while showcasing and protecting the area's geological heritage.[3]

### 3.2 UNESCO Global Geopark and the United Nations Sustainable Development Goals

The United Nations inform us on their formal website that "UN member countries adopted a set of goals to end poverty, protect the planet, and ensure prosperity for all as part of a new sustainable development agenda." [10] UN believes that the specific targets of each goal can be achieved over the next 15 years. A set of goals demonstrate the scale and ambition of this new universal Agenda called the United Nations' 2030 Agenda for Sustainable Development which is a plan of action for people, the planet, prosperity, peace and partnership. [11,12] From the UNESCO websites inform that UNESCO Global Geoparks contributing to 8 Sustainable Development Goals including [9]:

Goal 1 : End poverty in all its forms everywhere (especially target 1.5)

Disaster risk reduction is essential about ending poverty and fostering sustainable about development. The bottom-up approach of the UNESCO Global Geoparks reduces the vulnerability of local communities to extreme events and other shocks and disasters through active risk awareness and resilience training.

Goal 4 : Ensure inclusive and equitable quality education and promote lifelong learning opportunities for all (especially target 4.7)

UNESCO Global Geoparks actively educate their local communities and their visitors of all ages. They are outdoor classrooms and incubators for sustainable development, sustainable lifestyles, appreciation of cultural diversity and the promotion of peace.

Goal 5 : Achieve gender equality and empower all women and girls (especially target 5.5)

UNESCO Global Geoparks strongly emphasize the empowerment of women through educational programmes or the development of women's cooperatives which provide an opportunity for women to obtain an additional income in their own area and on their own terms.

Goal 8 : Promote sustained, inclusive and sustainable economic growth, full and productive employment and decent work for all (especially target 8.9)

The promotion of sustainable local economic development through sustainable (geo) tourism is one of the key pillars of a UNESCO Global Geopark. This creates job opportunities for the local communities through tourism, but also through the promotion of local culture and products.

Goal 11 : Make cities and human settlements inclusive, safe, resilient and sustainable (especially target 11.4)

Protecting, safeguarding and celebrating our cultural and natural heritage are the foundation of the holistic approach of the UNESCO Global Geoparks. UNESCO Global Geoparks aim to give local people a sense of pride in their region and strengthen the identification with the area.

Goal 12 : Ensure sustainable consumption and production patterns (especially target 12.8)

and 12.b)

UNESCO Global Geoparks educate and create awareness on sustainable development lifestyles. They teach the local communities and visitors to live in harmony with nature.

Goal 13 : Take urgent action to combat climate change and its impacts (especially target 13.3)

All UNESCO Global Geoparks hold records of past climate change. Through educational activities awareness is raised on the issue and people are provided with knowledge to mitigate and adapt to the effects of climate change.

Goal 17 : Strengthen the means of implementation and revitalize the global partnership for sustainable development (especially target 17.6, 17.9 and 17.16)

UNESCO Global Geoparks are all about partnership and cooperation, not only between local stakeholders, but also internationally through regional and global networks where knowledge, ideas and best practices are shared. Experienced geoparks guide aspiring geoparks to reach their full potential.

### 3.3 UNESCO Global Geoparks : protection with sustainable development

UNESCO Global Geopark promotes that best geopark should have 4 essential dimensions including geological heritage of international value, management, visibility and networking. [3]

According to the publication of UNESCO on UNESCO Global Geopark, the fundamental features which are an absolute prerequisite for an area to become a UNESCO Global Geopark including :

1) International value of Geological Heritage: This is the most important part of all geopark in order to become the UNESCO Global Geopark. UNESCO Global Geoparks must have the geological heritage of international value. This will be assessed by scientific professionals as part of the “UNESCO Global Geopark Evaluation Team”. Based on the international peer-reviewed, published research conducted on the geological sites within the area.

2) Management: UNESCO Global Geoparks are managed by a body having legal existence recognized under national legislation. This management body should be appropriately equipped to address the entire area and should include all relevant local and regional actors and authorities. UNESCO Global Geoparks require a management plan, agreed upon by all the partners, that provides for the social and economic needs of the local populations, protects the landscape in which they live and conserves their cultural identity. This plan must be comprehensive, incorporating the governance, development, communication, protection, infrastructure, finances, and partnerships of the UNESCO Global Geopark.

3) Visibility: UNESCO Global Geoparks promote sustainable local economic development mainly through geotourism. In order to stimulate the geotourism in the area, it is crucial that a UNESCO Global Geopark has visibility. Visitors as well as local people need to be able to find relevant information on the UNESCO Global Geopark. As such, UNESCO Global Geoparks need to provide information via a dedicated website, leaflets, and detailed map of the area that connects the area’s geological and other sites. A UNESCO Global Geopark should also have a corporate identity.

4) Networking: A UNESCO Global Geopark is not only about cooperation with the local people living in the UNESCO Global Geopark area, but also about cooperating with other UNESCO Global Geoparks through the Global Geoparks Network (GGN) , and regional networks for UNESCO Global Geoparks, in order to learn from each other and, as a network, improve the quality of the label UNESCO Global Geopark. Working together with international partners is the main reason for UNESCO Global Geoparks to be a member of an international network such as the GGN. Membership of the GGN is obligatory for UNESCO Global Geoparks. By working together across borders, UNESCO Global Geoparks contribute to increasing understanding among different communities and as such help peace-building processes.

According to the 4 pillars of UNESCO Global Geoparks, All pillars are very important part of all UNESCO Global Geoparks to confirm that geopark has the international value of geological heritages and managed in long term by management body legally. Management body should concern and focus on 10 key elements including : natural resources, geological hazards, climate change, education, science, culture, women, sustainable development, local community, indigenous knowledge and geoconservation. For eco-socio-economic development of the area, geotourism is key issues so visibility should be provided properly for visitors including infrastructures, interpretation panels, sign board, parking lodges, public transportation, websites, leaflets, brochures, maps and etc. UNESCO Global Geopark integrates both tangible and intangible heritages of the area together and promote as ideal destinations for educational activities but distraction or sale of original ornamental geological material is not permitted. [13] Networking is also a key feature of UNESCO Global Geopark both internal and external networking. Internal networking means the cooperation among local

stakeholders and key partners including local communities within geopark area. External networking is the collaboration between geopark and other networks included national or international networks. Networking is very important activity especially for capacity building, learning from other geopark experiences and practices, sharing the knowhow and knowledge among researchers, geologists, teachers, students, managers or local enterprises.

UNESCO has provided and published the Statutes and Operational Guidelines of the UNESCO Global Geoparks via the official website to assist the area to set up the the UNESCO Global Geopark including application dossier, self-evaluation form, template of geological and geographical summary and the timelines for UNESCO Global Geopark proposal and evaluation procedure [14] After the Aspiring Global Geopark submit the application dossier and pass the verification check. The experts form IUGS will do desktop evaluations then 2 nominated field assessors from UNESCO will visit Geopark for 3-4 days. The assessors' report will be recommend by the UNESCO Global Geoparks Council in September and decision will be finalized by the Executive Board of UNESCO during its spring session. After reward the UNESCO Global Geopark label, all geoparks shall be subjected to a thorough revalidation every 4 years.

### 3.4 UNESCO Global Geopark in Thailand : Satun Aspiring UNESCO Global Geopark

Satun province has been known widely as the destination of palaeontologists, geologists geomorphologists, and stratigraphers from around the world since 1951. It was a part of the Shan-Thai (Sibumasu) paleocontinent during the Lower and Middle Paleozoic. The Lower to Middle Paleozoic rocks with a variety of fossils outcrop in this area including the oldest fossils are represented by trilobites in the Upper Cambrian of the Tarutao Group, especially five new species of trilobite, i.e., Thailandium solum, Eosaukia buravasi, Saukiella tarudaoensis, Pagodia thaiensis, and Coreanocephalus planulatus. [15] Based on stratigraphical and paleontological studies on brachiopods, trilobites, conodonts, microvertebrates and gastropods of many paleontologists from Australia, England, Japan and the USA, it is verified that Thai fauna can be correlated with those of Myanmar, China, Australia and South America. Fossils are protected by the Fossil Protection Act, B.E. 2551(2008).

The Satun Aspiring UNESCO Global Geopark is located exclusively within Satun province, adjacent to the Andaman Sea. It covers Thung Wa, La-ngu, Manang, and part of Mueang Satun District (Tarutao National Park and Mu Ko Phetra National Park), with a total area of 2,597.21 km<sup>2</sup>.



**Figure 1** Satun Geopark Map  
Source: Department of Mineral Resources

Satun Aspiring UNESCO Global Geopark consists of four main topographical features as 1) Karst topography is karst landscape of Ordovician limestone such as monadnocks, karst towers, caves,



sinkholes, lapies, springs, waterfalls, and stromatolite lapies unique to the locality. 2) The Undulating Plain are younger sedimentary rock units (Silurian to Carboniferous including Quaternary) resulting in undulating terrain. 3) The Coastal Plain in the western and southern portion of the Satun Aspiring Geopark, is covered by Holocene alluvial sediments flowing from rivers also occur in this area to the sea. 4) Islands: All islands are located in Phetra National Park and Tarutao National Park consisting 20 islands in Phetra and La-ngu Districts and 51 islands in Mueang District, respectively. The Phetra and Tarutao islands are scenic topographic features of the proposed Geopark. Tarutao Islands is already the ASEAN heritage. Some area of geopark are protected by the National Park Act B.E. 2504 and some are managed by communities.

The population living within Satun Aspiring Geopark area, excluding Pethra and Tarutao National Parks, is about 113,110 people. In addition to ethnic Thai (including Buddhists, Muslim, and Christians), there are minority groups of indigenous people living in the proposed geopark, such as the Semung or Maniq ethnic group, which is a nomadic forest dwelling tribe thriving within inland evergreen forests and the Urak Lawoi or “Chao le” in Thai language who reside on the islands of LiPe and Adang, in the Adang Archipelago. The current population of the Maniq group in Satun Aspiring Geopark (Thungwa and La-ngu Districts) is approximately 100 people. The population of Chao le or sea dwellers is approximately 1,000 people. They live simply and independently on boats near the coastal area. The two ethnic groups live their lifestyle simply and closely connected to nature with their own languages, traditions, cultures, and beliefs

According to the rich uniqueness of geological heritages, Subdistrict Administrative Organizations, local Schools - Kamphaeng Witthaya School and Thungwa Worawit School, Satun provincial Administrative Organization, Satun office of Natural Resources and Environment, Songkhla Rajabhat University, Nakhon Ratchasima Rajabhat University Department of Mineral Resources and many stakeholders created the special event as the 1<sup>st</sup> Satun Fossil Festival, aimed to promote the fossils and geoheritages to the public in 2014. It was success, more than 30,000 visitors attended. Then all stakeholders realized that this unified area must be protected and promoted to the public for education and tourism internationally. Geopark concept presented by Department of Mineral Resources in the early of 2014. Therefore, Satun Geopark was established and celebrated as the provincial geopark since August 14<sup>th</sup>, 2014.

Satun Aspiring Geopark has the management organization which appointed by the governor of Satun province and led by Mr. Narongrit Thungprue, director of Satun Geopark. Satun Geoapark signed the memorandum of understanding in term of formal collaboration and strengthening the network among many stakeholders and partners in multi-levels from local to central government services including Provincial Administrative Organizations, Subdistrict Administrative Organizations, schools, universities, community college, research institutes, tourism agencies, national parks, wildlife sanctuary, communities, local enterprises, hotels, restaurants and etc. for the sustainability of the whole project.

Satun Geopark encourage local communities especially women group to participate the project in many dimensions including creating new products as geopark products such as the fossils and natural dye batik and bateh by Panya Batik group. New batik and bateh geopark products have the identity and create higher price which geological story and natural friendly. Chim’s melon with special taste and texture from Chim Melon Farm. It is a geopark agricultural product relates to the underground water of Karst landscape which contain high concentrate of calcium and magnesium substances. These both elements are important substances for the plants’ cell wall development. The fossil pattern on Chim’s melon creates the business extra price at least 30% per one melon. A sweet sticky rice in nepenthes pitcher plant is local traditional sweet which local community bring it back. Nepenthes pitcher plant farm has been established and opened for visitors as a learning center for 3 years. The old pitchers are cut for cooking - steamed sticky rice with coconut milk. This is traditional culture of locals. Many unique menus are created and provided by the local restaurants, geopark hotels, local homestay by Stegodon Homestay group – group of women nearby stegodon cave provide their houses as the certified homestay for visitors including local foods and some traditional cooking or handicraft short course, local geopark guides – local people who have additional trained by local community college in term of geological and natural heritage of the area. Kayaking group – local communities who have the para rubber wood farm in the geosite area. After work, they provide kayaking boat and kayaking trails for visitors. They can get additional income from kayaking service in many geosites, more than 40% additional income monthly.

Satun Geopark encourages and supports local school to get involved in this project – Thungwa Worawit school, geopark school is one of the best practiced school which integrated a regular class curriculum with local heritages education. Geological learning centre established and developed by Department of Mineral Resources then, this centre is later operated and supported by Science program of Thungwa Worawit school.

Learning centre provides education materials, exhibition and fossils which were found locally by students and teachers. According to the uniqueness of geological heritages (especially rich of fossils), some students were trained to be local guides by local geologist so they can provide some simple information on local geological heritage including the evolution of their land too. Expanding passion and knowledge from one student to other student, parents, family members and public, more people understand about their area and proud of their heritage. Raising awareness to more and more people to take care of their natural resources for next generation.

Satun Geopark has been well known by school, colleges, universities in the region. It is one of the best outdoor classroom and laboratories of Earth sciences about 500 million years ago. It is the simple evidence for students and visitors to understand the revolution of Earth and create awareness on sustainable development lifestyles, live in harmony with nature and take care of their earth for the next generations.

Satun Geopark has a strong network among the existing UNESCO Global Geoparks including international experts from UNESCO, Global Geopark Network and Asia-Pacific Geopark Network (APGN) and European Geopark Network (EGN) especially Langkawi UNESCO Global Geopark, Chinese Geopark Network and Japanese Geopark Network. Networking is very important issues for Satun Geopark development and management especially in the beginning stage of geopark establishment. Networking is the basic features to strengthen all partners and stakeholder together. It is the best practice for learning from other geopark experiences and knowledge sharing. Geopark is a dynamics process. New activities and projects need implementation and stepping forward.

Satun geopark is one of the best jigsaw to learn about our Earth evolution about 500 million years ago, the best international value outdoor classroom and laboratories of Paleozoic ocean accompany with abundant varieties of fossils. This is the heritage of all mankind. It is a sense of pride for Satun people to share with others. It should be protected and promoted globally. Therefore, on November 8<sup>th</sup>, 2016, the Thai Carbinet approved the Satun Geopark application dossier to be nominated as the UNESCO Global Geopark. The evaluation mission was done between July 24<sup>th</sup> - 29<sup>th</sup>, 2017 by the UNESCO nominated assessors from Portugal and People Republic of China. Recommendations on applications by the UNESCO Global Geoparks Council has been done since September 2017. The final decision by the Executive Board of UNESCO will be decided during its spring session.

Satun Aspiring UNESCO Global Geopark can be one of the best model for Thailand sustainable development empowering local communities involvement according to 2030 Agenda for Sustainable Development and one of the model, which support the development approach on Sufficiency Economy Philosophy (SEP) which has great relevance and wide applications for all people and sectors both poor and affluent alike based on societal and geographical conditions. [16]

#### 4. Conclusions

Geopark is the new integrated management concept which created and developed by Chinese and European networks. Global Geopark is part of the International Geoscience and Geopark program of UNESCO. UNESCO Global Geopark promotes sites of International Value and are the basis of local sustainable development. It is one of the sustainable development tools to ensure the balance between conservation of heritage, development of tourism and infrastructure and enhancement of local participation and socio-economic development. There are 127 UNESCO Global Geopark in 35 countries around the globe in 2017.

UNESCO Global Geoparks support 8 Sustainable Development Goals of the United Nations 2030 Agenda for Sustainable Development including Goal 1 : End poverty in all its forms everywhere, Goal 4 : Ensure inclusive and equitable quality education and promote life long learning opportunities for all, Goal 5 : Achieve gender equality and empower all women and girls, Goal 8 : Promote sustained, inclusive and sustainable economic growth, full and productive employment and decent work for all, Goal 11 : Make cities and human settlements inclusive, safe, resilient and sustainable, Goal 11 : Make cities and human settlements inclusive, safe, resilient and sustainable, Goal 12 : Ensure sustainable consumption and production patterns, Goal 13 : Take urgent action to combat climate change and its impacts and Goal 17: Strengthen the means of implementation and revitalize the global partnership for sustainable development.

UNESCO Global Geoparks has 4 essentials which support the aims of geopark including geological heritage of International Value, management, visibility and networking. UNESCO Global Geoparks are focusing on both tangible and intangible Resources of the area including natural resources, geological hazards, climate change, education, science, culture, women sustainable development, local and indigenous knowledge and geoconservation. In order to achieve the standard of UNESCO Global Geopark, Aspiring Geoparks should follow the Statutes and Operational Guidelines of the UNESCO Global Geoparks. Visibility is very important

part. Aspiring Geopark should provide the visibility in the area for visitors and local communities. Management requires a solid, efficient, flexible and capable structure, system and process which cover protection, promotion, education, socio-economic development and progress of the geopark.

Satun Aspiring UNESCO Global Geopark, located in Southern Thailand with a total area of 2,597.21 km<sup>2</sup> is the 1<sup>st</sup> Thai National Geopark nominated as the UNESCO Global Geopark by Thai government in 2016. It was formed by the requirement of communities, aimed to protect and promote their heritage sustainably. It is action from the bottom up. It took at least 3 years to reach the UNESCO Global Geopark criteria by the strongly support of many stakeholders and strategic partner including the Satun governor office, Satun office of Natural Resources and Environment, Provincial Administrative Organization, 14 subdistrict Administrative Organizations, 2 subdistrict municipalities, Department of Mineral Resources, national parks, wildlife sanctuary, universities, community college, schools, local enterprises, hotels, restaurant, travel agencies, local communities and etc. Satun UNESCO Global Geopark has a strong network among the existing UNESCO Global Geopark including international experts from UNESCO, Global Geopark Network and Asia-Pacific Geopark Network (APGN) and European Geopark Network (EGN)

### Acknowledgements

We would like to send our sincere gratitude to the president of Vongchavalitkul University, president of Nakhon Ratchasima Rajabhat University, director general of Department of Mineral Resources, the Japan Geopark Network, the Asia-Pacific Geopark Network and UNESCO Global Geopark Secretariate for supporting on geopark establishment in Thailand and important information.

### References

- [1] Mc Keever P. UNESCO Global Geoparks. *GeoExPro* : The favourite petroleum geoscience magazine. 2017. 14(1) : 74
- [2] Asia Pacific National Geoparks, APGN Geoparks. 2017. [cited 17 July 2017]. Available from : [http://asiapacificgeoparks.org/?page\\_id=78](http://asiapacificgeoparks.org/?page_id=78)
- [3] UNESCO. UNESCO Global Geoparks. 2017. [cited 17 July 2017]. Available from : <http://unesdoc.unesco.org/images/0024/002436/243650e.pdf>
- [4] Mc Keever,P. UNESCO Global Geoparks. *GeoExPro* : The favourite petroleum geoscience magazine. 2017. 14(1) : 74
- [5] Komoo,I and Patzak, M. Global Geopark Network : An Integrated Approach for Heritage Conservation and Sustainable Use, in Leman, M.S, Reedman, A and Chen, S.P (eds) Southeast and East Asia Geoheritage Conservation, Bangi: LESTARI UKM: 1-13.
- [6] Jones, C. 2008. Geological Society of London, special Publications. , 300, 273-277, [cited 11 July 2017]. Available from : <http://sp.lyellcollection.org/content/300/1/273>
- [7] Hashim HS, Azia Sarah, Aziz, Rahimah Abdul. Conservation with development : showcasing Langkawi GEOapark. *Planning Malaysia Conservation with development: Focus on Langkawi*. 2011; 1-24
- [8] IUGS - Geoheritage Task Group (GTG). Some announcements regarding global geoheritage matters at the end of 2015. *The new ProGeo Newsletter* : Number 1 2017. [cited 17 July 2017]. Available from : <http://geoheritage-iugs.mnhn.fr/index.php>
- [9] UNESCO. UNESCO Global Geoparks. 2016. [cited 1 July 2017] Available from : <http://unesdoc.unesco.org/images/0024/002477/247741E.pdf>
- [10] United Nations. Sustainable Development Goals. 2017. [Cited 19 July 2017] Available from : <http://www.un.org/sustainable-development/sustainable-development-goals>
- [11] United Nations. Resolution adopted by the General Assembly on 25 September 2015. 2015. [Cite 19 July 2017] Available from : [http://www.un.org/ga/search/view\\_doc.asp?symbol=A/RES/71/Lan](http://www.un.org/ga/search/view_doc.asp?symbol=A/RES/71/Lan)
- [12] UNESCO. UNESCO Global Geopark contributing to the Sustainable Development Goals. 2017. [cited 17 July 2017]. Available from : <http://unesdoc.unesco.org/images/0024/002436/243650e.pdf>
- [13] Zouros,N. and Valiakos, I., 2010. Geoparks Management and Assessment. *Bulletin of the Geological Society of Greece*, 2010 and *Proceeding of the 12th International Congress*, Patras,May, 2010.
- [14] UNESCO. UNESCO Global Geoparks. 2017. [cited 17 July 2017] Available from : <http://www.unesco.org/new/en/natural-sciences/environment/earth-sciences/unesco-global-geoparks/>
- [15] Kobayashi, T., 1957, Up per Cambrian fossils from peninsular Thailand, *Jour. Faculty of Science, Tokyo University*. 2(10) 3, p.367-382.
- [16] Sithtichoti K. Sufficiency Economy Philosophy : a Practical Approach toward the United Nations

Sustainable Development Goals. Proceeding international conference of multidiscipline approach on UN Sustainable Development Goals (UNSDGs 2016) . 2016. [cited 17 July 2017]. Available from : [http://dept.npru.ac.th/unsdgs2017/data/files/Full%20proceedings%20UNSDGs%202016\\_1.pdf](http://dept.npru.ac.th/unsdgs2017/data/files/Full%20proceedings%20UNSDGs%202016_1.pdf).

# Managing Sustainable Development

Pradip Peter Dey<sup>1,\*</sup>, Ronald P. Uhlig<sup>1</sup>, Laith Al Any<sup>1</sup>, Mohammad Amin<sup>1</sup>

<sup>1</sup>Bhaskar Raj Sinha, Hassan Badkoobehi  
School of Engineering and Computing, National University,  
3678 Aero Court, San Diego, CA, San Diego, California, USA

## Abstract

Appropriate management strategies can be advanced for sustainable development using broad-based development strategies that benefit most humans throughout the world for the foreseeable future without causing harm to humanity, resources and environment. Gradually new approaches to development are taking place in the increasing number of wind turbines and solar panel installations, planting new trees and introducing eco-literacy curricula in schools and in many other intuitive ways. Sustainable development may be relatively slow, but it does not do long term harm to environment and humanity. Any nation can play a leading role in developing management strategies for sustainable development with good local applications within a global framework. Population groups in various parts of the world practiced in sustainable development before industrialization, elements of which can be revived now. Modern technology of war, internal combustion engines, deforestation, toxic waste, and other assaults on sustainability often cause long term harm to our environment and dampen our spirit of sustainable development. Despite these obstacles, peoples are rededicating themselves to replace wars by peace and hate by love for the planet and humanity and measurable progress towards sustainable development goals. Sustainable development needs to be supported by careful selection of technology, investment in peace, education and research. Deceptive paradoxical claims about accelerated development should be rejected and their impact on environment needs to be investigated. Development of mathematical models of sustainability for specific applications can be key to identifying which variables to manage for the best results. Research on sustainable development is challenging, because it requires robust multidisciplinary approaches and without a large multidisciplinary team of experts it is difficult to treat various research aspects adequately. However, collaborative research teams of experts can be created taking participants from multiple nations and disciplines in order to serve humanity with a long term view of sustainable development.

**Keywords:** air pollution, automobiles, environment, economy, global warming

## 1. Introduction

From our collective knowledge and experience of the past few thousand years we have come to realize that we have a profound relationship with Planet Earth: we need the Earth as the Earth needs us. We need the Earth for sustainable development so that our next generation can live on it without facing catastrophic environmental disasters. The Earth needs us to take friendly actions for cleaning its air and environment for sustaining habitat for life. Every nation wants to achieve and maintain healthy economic development with strong GDP (gross domestic product) growth. However, high GDP growth rates must not be an end in themselves. For example, high GDP growth accompanied by high growth in environmental hazards is not desirable. It is always important to consider potential side effects of growth processes. For example, processes which cause cancer or other health hazards to us or our children, are not likely to be acceptable. In a shared environment, wealth creation that is accompanied by damaging each-other's children's long term health or potentials, is not acceptable. We live in a society. We depend on each-other in so many ways. We share the air we breathe, the seasonal changes, and the planet earth in so many intricate ways that are often not immediately perceived. In consideration of these shared interests, concerns, potentials and risks, we need to reconsider our global citizenship, shared responsibilities, and sustainable development goals. When we think about development we must take into consideration related issues such as possible chemical hazards, climate change, environmental consequences and long-term benefits.

---

\* Corresponding author; e-mail: apdey@nu.edu

Human groups often do not agree on these issues. However, collegial discussions with mutual respect need to be conducted for the benefit of all. Hopefully, our discussions will lead to better understanding of each other's concerns as well as information exchange and exchange of mutually beneficial ideas. The problem is global and we need to appeal to global citizenship. The United Nations and other organizations often sponsor multicultural events for better understanding of the relationships among environmental concerns, economic development, social progress and health and human issues [1].

The spirit of humanity, to which we aspire, rises to challenges and sacrifices for the good of the coming generations. The UN 2030 Agenda for Sustainable Development says, "We are determined to protect the planet from degradation, including through sustainable consumption and production, sustainably managing its natural resources and taking urgent action on climate change, so that it can support the needs of the present and future generations" [1]. This can be considered, without any hostile feelings, as one of the perspectives among many others without any prejudgments.

The fact that our concerns are shared is fundamental. In addressing shared concerns we need to listen to each other. During the industrial revolution impacts on the environment, such as air pollution, were noticed even by common people. Air pollution increased rapidly with the growth of coal consumption and rapid growth of the automobile industry and other factors. According to David Wallace-Wells, unless there is a significant change to how billions of humans conduct their lives, "parts of the Earth will likely become close to uninhabitable, and other parts horrifically inhospitable, as soon as the end of this century" mainly due to climate change [2]. Many scientists who study the subject give similar warnings about internal combustion engines, use of coal, deforestation, global warming etc. with some variations. At the same time, excellent progress on reducing air pollution has been made in some parts of the world, and this should be encouraging to those parts of the world that are currently plagued with severe pollution.

In this paper, we suggest some mechanisms for developing management strategies that can be effective in reducing the impact of climate change and promoting sustainable growth. Information technology will play an important role in raising awareness about climate change. We discuss below the development of detailed mathematical models to identify specific variables that can be managed to improve sustainability. Using Information Technology to disseminate how the models work may also help in exchange of ideas and coordinating actions of various groups towards achieving the goals stated in United Nations documents [1].

The sustainable development paradigm comes with many studies. It presents a workable "alternative that supports economic viability and healthy ecosystems by modifying consumption patterns and implementing a more equitable social framework" in a pragmatic way [3]. Scientific studies about environment and climate change come with some range of uncertainties. Reasoning with uncertainties presents some challenges. However, our goal is to benefit from these studies with proper understanding and manage the risks. We want to prevent deterioration of the ecosystems on which we depend for our well-being. Taking the uncertainties into proper perspective from multiple studies is important.

## 2. Review of literature with perspectives

Robust exchange of ideas, views and information on sustainable development is important. Conferences, debates, journal articles, books and magazines should raise sustainable development issues and will allow scientists, engineers, policy makers and political leaders to participate in the discussions. Management of sustainable development is extremely challenging and requires carefully developed well-balanced approaches.

Most experts believe that "the popular interest in management as a discipline and a field of study is fairly recent" [4, page 12]. However, there were several pioneers such as Henry Gantt who developed planning and control techniques with a chart, popularly known as the Gantt chart as early as 1919 [5].

Modern concepts of management were developed in the U.S.A. after World War II and these are currently taught all over the world in institutions of higher education. The four main management functions one may learn in school are "planning, organizing, leading, and controlling" [6, page 5]. One may argue for adding to the list more functions and skills such as communicating, decision making, meeting ethical standards, analytical thinking, coaching, listening, negotiating, visioning and mitigating risks. There are many perspectives on sustainable development and one must be ready to listen to others to find common ground, because it is through the shared views and concepts that initial progress can be made.

One of the challenges for sustainable development is coordinating regional and national development with international institutions and other nations because some aspects of sustainable development requires global cooperation [1, 7, 8]. The United Nations published several articles related to the goals of sustainable development [1, 7, 8]. It continues to sponsor important conferences and symposia addressing very important issues about sustainability. The United Nations conferences provided forums for discussing important issues and for exchanging ideas about managing development. It became apparent that there might not be any centralized global management strategies acceptable to all nations as national leaders were primarily interested in serving their national interests only. The United Nations continued its efforts in coordinating the

development of the distributed decentralized management strategies in a global framework. In the meantime, various global conferences allowed discussions of the global nature of issues of climate change and related challenges of sustainable development. One example is the Earth Summit held in Rio de Janeiro in 1992 as the United Nations Conference on Environment and Development (UNCED) [9]. The United Nations Agenda 21 started some useful debates and critical thinking about sustainable development with objectives such as “To promote patterns of consumption and production that reduce environmental stress and will meet the basic needs of humanity;” [10]. Making statements about global sustainable development goals the United Nations promoted constructive thinking about management issues in this area. As a result, there is a better understanding of the issues today and a greater awareness that The United Nations is calling on everybody to play a role in meeting the sustainable development goals.

We can all benefit from good examples. There are some excellent examples that can be followed in order to replicate their success in many areas. Sweden, Denmark and Norway are among the top performers in sustainable development making excellent progress towards UN (United Nations) 2030 sustainable development goals [11]. “Asia-Pacific’s top performers Japan, Singapore and Australia rounded off the list at 18th, 19th and 20th, respectively” [11]. There are opportunities for following some of the management strategies of these countries with appropriate adjustments for local applications.

Nevertheless, it is inevitable that some will feel threatened by proposed management changes, and some may actually be threatened. Ways need to be identified to phase in changes needed for sustainability so that organizations and individuals can absorb the changes without being forced into a position of having their “backs against a wall.” If they believe the changes endanger their survival they will fight. This implies compromise, and is part of what the authors meant above when they talked about “listening to each other.” Unfortunately, some of the current debate is more like a war than a dialog. Everyone loses in a war.

An important aspect of managing sustainable development is to manage waste and environmental aspects. Management of recycling plastics, metallic cans, containers, and used clothing helps our environment in addition to bringing awareness of sustainability to the general public. Many K-12 schools participate in recycling projects where students’ involvement is encouraged. Some schools have an introductory course on sustainability that introduces certain basic aspects of the field in a proper context. Students who develop interests in this area may pursue an undergraduate degree in sustainability which is offered in many colleges and universities. One of the largest global recycling industries that has come into being over the last several decades is recycling of used clothing. The size of this global industry is estimated at over US\$4 billion today [12]. This is one example of upcycling - the process of changing and transforming waste materials into good products for better environmental value [13]. So-called eWaste is another example. Creatively developing new products from old electronic components is demonstrating excellent service to many communities in several parts of the world. Upcycling creatively makes a positive impact on the environment. Developing appropriate management strategies in more industrial sectors for upcycling will contribute towards more and better sustainable development goals.

### **3. A mathematical model of sustainability**

Most of us have an intuitive understanding of sustainability and we are motivated to have some sustainable development goals for ourselves for our own benefits. We all practice sustainability all the time on an individual basis. To do otherwise would be foolish. We manage our finances so that we do not run out of funds. We conserve our clothing so that it will last until we have sufficient funds to replace worn out items. We manage our food, so that we have enough to last until we can replenish our supply. These few examples are sufficient to illustrate that managing sustainability is a natural and instinctive practice for survival on an individual basis. On an individual basis, we do this precisely, typically using budgets for ourselves and our families. We consider various ways in which we could spend our money and then make choices among the various alternatives. This is a relatively primitive form of mathematical modeling. Problems arise when we begin to address sustainability collectively. It is at that point that competition arises for resources whether or not they can be replenished. One person, group, or nation seeks to use a resource faster than it can be replenished, usually to gain short term profit. At a macro level, non-sustainable practices are counterproductive, because, while they may produce high levels of profit for a short time, they then produce zero or negative profits after resources are depleted. One issue is what is meant by “short time”. For sustainability, “short term” probably implies decades and sometimes even centuries. Another issue is whether the resource being depleted is renewable, in other words temporary depletion versus permanent depletion.

From this perspective, the process of sustainability can be viewed as an economic issue, driven by depletion rates, time constraints, cost constraints, and renewability constraints. The time constant is related to the time to replenish key resources being consumed or to find acceptable alternatives (such as replacement). This may be a linear process, or it may involve some more complex relationship. Ideally, we can look at a simple equation stating that the amount we use of a particular resource over a particular time must not be greater than the amount of resource that can be replenished in the same amount of time. This can be stated as:

$$\int_{t_1}^{t_2} D(t)dt \leq \int_{t_1}^{t_2} R(t)dt$$

Where  $D(t)$  = the depletion as a function of time for a resource and  $R(t)$  = the replenishment as a function of time for the resource.  $t_1$  = the starting point in time for sustainable management of the resource and  $t_2$  = the end point for a particular management period. The variables, “ $D(t)$ ” and “ $R(t)$ ”, can be quite complex functions, reflecting various approaches to production and to replenishing or replacing resources that are being consumed over the same time period. This simple equation can be extended to multiple resources, but it must be at the heart of any sustainable management practice. Both sides of the equation are functions not only of time, but of many other variables as well.

Managing the quantity of a resource is only part of the picture. Costs must also be addressed. Businesses seek to minimize the cost of processing resources, and this drives things like economic lot sizes, which, in turn, drives the form of the function for “ $D(t)$ ” in the equation above. From a societal perspective, the cost of replenishment must not exceed the cost of consuming (or depleting) a particular resource. However, the cost of replenishment may not be a cost to the organization which is using the resource; it may be a cost to another organization, or even to a single country. As a result, there may not be a business motivation for ensuring that depletion and replenishment are synchronized.

Cost is a powerful motivation for sustainability on an individual basis, but when the cost accrues to someone other than the individual or organization using up the resource, that missing or mismatched cost motivation makes sustainable management practices difficult. This implies that the integration on the left side of the equation (the depletion side) must go over all individuals and organizations contributing to the depletion, while the integration on the right hand side of the equation must go over all who are concerned with the corresponding replenishment and/or replacement processes. This implies that, in addressing sustainability, we must take a “big picture” view of the process, or at least a “bigger picture” view than is apparent to many organizations.

If the “cost of replenishment” is viewed as a cost to society, it may be treated as a cost to an entire country. It may then be possible to transfer the cost to the organization(s) responsible for the depletion. This could be in the form of taxes, but taxation is a very contentious process, and fraught with political issues. Carbon offsets are an example of an only slightly less contentious approach to transferring responsibility for the cost of “depletion” in the form of pollution of the atmosphere, to entities responsible for the depletion. In this case, we are all responsible for production of excess  $CO_2$  but some activities produce much more  $CO_2$  than others.

True management of sustainability requires identification of a correct set of variables for each side of the equation. In reality the process is too complicated to be reduced to such a simple equation. Instead, each side of the equation must be replaced with mathematical simulations of the depletion process on the left hand side and the replacement or repair process on the right hand side. By developing such simulation models, we can analyze variables on both side of the equation to identify the most important ones; these will be the variables that we seek to manage. Exploring options for the variables requires complex simulation models, using information technology.

A number of simulation models for sustainability have been developed, and more are needed in the future. One example is the work done by Jason Phillips in applying a mathematical model of sustainability to an environmental impact assessment of iron ore opencast mines. This very detailed work, employing the Folchi method [14], suggests how mathematical models can be developed to identify critical variables to be managed for sustainability [15]. Another example is the work done Galal and Moneim [16] in their mathematical analysis of an optimal sustainable product mix for the process industry. They devised a complex mathematical model “to help decision makers in setting up their product mix and other vital operating parameters, so as to maximize manufacturing sustainability.” These are but a few of many encouraging examples of detailed mathematical models for managing specific aspects of sustainability. Technology will help in the process of sustainable development in many ways [17].

A geoengineering approach to reduction of global warming is considered by some scientists [18-19] which involves spraying reflective particles into the stratosphere using airplanes or tethered balloons. A “simple model to account for the potential effectiveness of solar radiation management” is presented in [18]. Cost-effectiveness is considered to be one of the main advantages of this approach; however, it has potential environmental risks.



#### 4. Conclusions

A consensus on sustainable development is likely to emerge soon. However, deeper understanding of underlying commonalities among multiple threads and viable models is being achieved due to persistent efforts. Such models represent a modest beginning of sustainable development that is underway in many parts of the world with enormous potentials. Its long-term implications include some profound socioeconomic transformations with global supports for building healthy ecosystems. Managing sustainable development is challenging; however, it also presents opportunities for the future. One of the challenges is that the fruits of sustainable development cannot be usually realized in a short period, because it often takes decades to see measurable effects. So, now is the time to get started. We have a profound realization that we need to work together with everybody in a cooperative friendly manner for a very long time in order to achieve our brilliant goals. Let our sustainable development journey begin with joy. A possible direction of study could be further development of a model of sustainable development management.

#### References

- [1] United Nations. Transforming our world: the 2030 Agenda for Sustainable Development; 2015. Retrieved on July 15 from: <https://sustainabledevelopment.un.org/post2015/transformingourworld>
- [2] Wallace-Wells, D. The Uninhabitable Earth, New York Magazine, July; 2017.
- [3] Edwards, A. R. The Sustainable Revolution. New Society Publishers; 2005.
- [4] Drucker, P. Management (Revised Edition), Harper Collins, New York; 2008.
- [5] Gantt, H. Organizing for Work, Harcourt, Brace, and Howe, New York; 1919.
- [6] Nelson, B. & Economy, P. The Management Bible, John Wiley & Sons, Hoboken; 2005.
- [7] Mochizuki, Y. Educating for Transforming Our World: Revisiting International Debates Surrounding Education for Sustainable Development, Current Issues in Comparative Education (CICE), Volume 19, Issue 1, Fall 2016. Retrieved July 14, 2017 from: [http://www.tc.columbia.edu/cice/current-issue/09\\_Mochizuki.pdf](http://www.tc.columbia.edu/cice/current-issue/09_Mochizuki.pdf)
- [8] United Nations, Sustainable Development Goals; 2016. Retrieved July 12, 2017 from <http://www.un.org/sustainabledevelopment/sustainable-development-goals/>
- [9] United Nations. The Earth Summit: United Nations Conference on Environment and Development (UNCED). Retrieved July 12; 2017 from <http://www.un.org/geninfo/bp/enviro.html>
- [10] United Nations. Conference on Environment & Development: Agenda 21; 1992. Retrieved July 11, 2017 from: <https://sustainabledevelopment.un.org/content/documents/Agenda21.pdf>
- [11] World Economic Forum. Which countries are achieving the UN Sustainable Development Goals fastest? March; 2017. Retrieved July 26, 2017 from: <https://www.weforum.org/agenda/2017/03/countries-achieving-un-sustainable-development-goals-fastest/>
- [12] LeBlanc, R. Social Implications of Exporting Second Hand Clothing to Developing Countries, downloaded Aug. 30; 2017 from <https://www.thebalance.com/exporting-old-clothes-2878008>
- [13] McDonough, W. & Braungart, M. The Upcycle: Beyond Sustainability - Designing for Abundance, North Point Press; 2013.
- [14] Folchi, R. Environmental impact statement for mining with explosives: a quantitative method, in: I.S.E.E 29th Annual Conference on Explosive and Blasting Technique, Nashville, Tennessee, USA, February 2-5; 2003
- [15] Phillips, J., The application of a mathematical model of sustainability to the results of a semi-quantitative Environmental Impact Assessment of two iron ore opencast mines in Iran, Applied Mathematical Modelling, Vol. 37, Issues 14-15, 1; Aug 2013, pages 7839-7854
- [16] Galal, N.M. and Moneim, A.F.A., A Mathematical Programming Approach to the Optimal Sustainable Produce Mix for the Process Industry, Sustainability; 2015, 7, 13085-13103; doi:10.3390/su71013085
- [17] Vergragt, P. J. How Technology Could Contribute to a Sustainable World, Tellus Institute; 2006. Retrieved July 26, 2017 from: [http://www.greattransition.org/archives/papers/How\\_Technology\\_Could\\_Contribute\\_to\\_a%20Sustainable\\_World.pdf](http://www.greattransition.org/archives/papers/How_Technology_Could_Contribute_to_a%20Sustainable_World.pdf)
- [18] Moreno-Cruz, J., Rieke, K. & Keith, D. A simple model to account for regional inequalities in the effectiveness of solar radiation management, Climatic Change, 110: 649-668, 2012.
- [19] Keith, D. & Weisenstein, D. K. Solar geoengineering using solid aerosol in the stratosphere, Atmos. Chem. Phys. Discuss., 2015.

# Promoting Sustainable Development Goals through Corporate Social Responsibility (CSR) Practices: Cases of Rural Hotels in Bali, Indonesia

Luh Putu Mahyuni<sup>1,\*</sup>, I.B Teddy Prianthara<sup>2</sup>

<sup>1</sup>Universitas Pendidikan Nasional (Undiknas University), Jl. Bedugul 39, Sidakarya, Denpasar, Bali, Indonesia 80225

<sup>2</sup>Universitas Pendidikan Nasional (Undiknas University)

## Abstract

Sustainability issue is gaining its significance worldwide as the United Nation sets 17 sustainable development goals (SDGs) to be achieved by 2030. Various approaches have been undertaken by many countries to promote SDGs. Many studies have also been conducted to find out the appropriate model, mechanism and method in promoting SDGs. The aim of this paper is to investigate how SDGs are promoted through CSR practices. Case studies of three big rural hotels in Bali, Indonesia were conducted. The results show that the three hotels align their business and social goals through long-term partnerships with the local society. By doing so, the economy of the local society thrives as the hotels grow. Some prominent practices are: (1) assisting the locals in cultivating organic fruits and vegetables to ensure the continuity of supply of organic produces for the hotels' restaurant, (2) green-bank initiative whereby the locals are assisted in reducing, reusing and recycling the wastes to maintain the cleanliness of the hotels environment, (3) employing the locals to obtain support from the local society, (4) English course program for the locals to enable better interaction between the hotel guests and the locals. CSR practices of the three hotels have contributed to the effort to combat poverty and hunger, improve the health and wellbeing, improve quality education, promote decent work and economic growth. However, promoting the 17 SDGs requires not only the private sectors but also the government efforts. This paper contributes to the body of knowledge related to the SDGs by revealing how SDGs could be promoted through CSR practices. This paper also shows that it is possible to align business and social goals through CSR practices.

**Keywords:** sustainable development goals, corporate social responsibility practices, rural hotels, emerging economy

## 1. Introduction

On September 25th 2015, the United Nations (UN) sets 17 Sustainable Development Goals (SDGs) to be achieved by 2030. The goals are: 1. No poverty, 2. Zero hunger, 3. Good health and well-being, 4. Quality education, 5. Gender equality, 6. Clean water and sanitation, 7. Affordable and clean energy, 8. Decent work and economic growth, 9. Industry, innovation and infrastructure, 10. Reduce inequalities, 11. Sustainable cities and communities, 12. Responsible consumption and production, 13. Climate action, 14. Life below water, 15. Life on land, 16. Peace, justice and strong institution, 17. Partnerships for the goals. The UN stresses the importance of involvement of many parties, such as governments, private sectors, NGOs and civil society in reaching the goals by 2030.

The academia and researchers contribute in promoting SDGs by conducting research to investigate various approaches, models and mechanisms applied to promote SDGs. One stream of research related to this matter is research on Corporate Social Responsibility (CSR). Although the number of research on CSR has increased significantly in the last few decades, until now there is no agreed single definition of CSR. The definition of CSR spans from a mere philanthropy activities [1-3] to a complex business strategy [4, 5]. However, the components of CSR are consistently being discussed in the literature, such as concern for economics, legal, ethical, people/ stakeholders and the environment. Among those definitions, the CSR definition used by The Commission of the European Communities is the most cited [6, 7]. CSR is defined as “a concept whereby companies integrate social and environmental concerns in their business operations and in their interactions with their stakeholders on a voluntary basis” [6]. This paper adopts CSR definition defined by The Commission of the European Communities.

The concept of CSR is closely related to the idea of sustainability whereby a company bears responsibility to *take full account of its current and future economic, social and environmental impacts*. Hence,

---

\* Corresponding author; e-mail: lpmahyuni@gmail.com

*investigating CSR practices of certain companies could reveal alternative method in promoting UN SDGs. With this regard, this paper contributes by revealing how UN SDGs are promoted through CSR practices.*

## 2. Objective

The objective of this paper is to investigate how Sustainable Development Goals (SDGs) are promoted through Corporate Social Responsibility Practices (CSRPs)

## 3. Methods

In order to achieve the objective of this paper, case studies were conducted on three big rural hotels in Bali. Two hotels are located in Ubud - Gianyar and one hotel is located in Manggis - Karangasem. Ubud is well known as a favourite tourist destination for spiritual retreats and holistic healings. Most hotels in Ubud are located along the bank of the Ayung River. Manggis is famous for its pristine beaches and authentic traditional culture. Big rural hotels are chosen as the object of the case studies for several reasons: 1. Big hotels bring about greater impact to the society and the natural environment, 2. Rural hotels are much dependent on the natural environment, and 3. As most rural hotels are nested in traditional villages, maintaining harmonious relationship with the locals is very important for these hotels. By choosing big hotels that have great dependency on the natural environment and the local society, rich information related to Corporate Social Responsibility Practices (CSRPs) is expected can be obtained.

Case study is one type of qualitative study which focus on investigating certain issue or problem exist in certain setting or context [8]. In a case study, certain phenomenon is explored deeply through in-depth data collection from various sources of data. This study collects data through hotels' websites and interviews with hotels' general managers. All participants had been informed prior to the interview that they are guaranteed anonymity. This procedure is applied to minimise social desirability bias, i.e., the participants possibly inaccurately answer questions to present themselves in a more favourable light [9]. The interviews ranged from 45 to 90 minutes in duration. The interviews were conducted in English, Bahasa Indonesia, and some Balinese language. The translations of the interview transcripts to English were checked by a professional translator.

The interview transcripts were coded with the help of NVivo11. Segments of the interview transcripts were then organised according to the core themes identified and quotations that represent a particular theme were extracted from these transcript segments to add richness to the findings.

## 4. Results and Discussion

### 4.1. The Context of Bali

Bali is one of 33 provinces in Indonesia. Administratively, the province of Bali is divided into nine regions, namely Denpasar, Badung, Gianyar, Klungkung, Karangasem/ Amlapura, Bangli, Buleleng/ Singaraja, Tabanan and Jembrana/ Negara. Denpasar is the capital city of the Bali province. The locations of the regions are circled in Figure 1.



**Figure 1.** Bali Map (Source: [www.balitravelhound.com](http://www.balitravelhound.com)).

The tourism industry has been the major driver of the economy of Bali. The number of international tourists visit Bali is almost 92% of the total population of Bali and made up 40% of the total international visitors visit Indonesia [10]. As such, it is clear that Bali has been the main driver of the tourism industry in Indonesia. Hence, the context of Bali is significant for tourism research in Indonesia.

Although the vast development of mass tourism in Bali brings benefits to the economy of Bali, it also creates numerous problems. The problems can be categorised as social, cultural and environmental problems. Therefore, it is very important to investigate the hotels efforts in maximising their contribution to the local society and economy without imposing negative impacts to the environment. Such efforts are discussed deeply in the following sub sections.

#### 4.2. Case 1

Hotel 1 promotes itself as a premium residential health retreat combining holistic healing with exceptional villa accommodation. The hotel is located along the bank of the Ayung River where the natural environment is still pristine. It is also nested in the traditional Balinese villages. The hotel management realises the importance of preserving the natural beauty of its environment and maintaining harmonious relationship with the local society in ensuring the sustainability of the hotel operation. As stated by the general manager, *“I think definitely nowadays more people will come to a resort if they know you care about the environment. They are coming more if they know that you have got the CSR programs in place”*. In general there are two types of Corporate Social Responsibility (CSR) practised by the hotel, namely CSR to the local society and CSR to the environment.

The hotel employs many local people. More than 75% of total staff are local people living in the surrounding villages. This policy is driven by motivation to support the villages by providing the opportunity to the locals to get a better future. The hotel also contributes to the economy of the local society by supporting the local entrepreneurs. The hotel is committed to source hotel supplies from the local community, *“We’re buying products from local suppliers so we’re supporting local entrepreneurs. We’re not gonna sourcing outside from Bali. It’s a sort of social responsibility in terms of taking care about local production plus reducing the footprint as well”*. Besides contributing to the economy of the local society, the hotel also actively engages in various educational programs, such as health education, English language and literacy, and support for primary schools and kindergartens.

In terms of effort to preserve the environment, the hotel involves the local farmer. The hotel provides technical assistance and support for the local farmers to produce organic produces. By doing so, the hotel could ensure sustainable supply of organic produces for its kitchen, at the same time fosters the economic growth of the villages and contributes to the environment preservation effort. The hotel is also committed to use natural products only in its property. It is not just because it is good for the environment but also because it is expected by the guests, *“When you go to the room you’ll find that we don’t use any chemical. We try to use natural products as much as possible. Our guests frequently ask what kind of product you use for cleaning, what kind of product you use for mosquitos for example”*.

In case 1, the management of the hotel practises CSR as a strategic means to ensure the sustainability of the hotel operation and at the same time contribute to the society and the environment. The hotel has contributed in promoting sustainable development goals by: 1. Providing jobs and supporting the local entrepreneurs, therefore contibuted in combating poverty and promoting sustainable economic growth, 2. Delivering health education to the locals, hence promoting good health and well-being, 3. Offering support for primary schools and kindergartens → promoting quality education, 4. Promoting organic farming and using natural products → action to minimise the impact of climate change.

#### 4.3. Case 2

Similar to hotel 1, hotel 2 is also located beside the Ayung River. It is surrounded by lush forest greenery and working rice paddies. The hotel market itself as a special place to restore body, mind and soul. The management acknowledges the interdependencies of the hotel with its surrounding. The general manager stated, *“The successful of the company depends on the surrounding, the local community, the taxi drivers, the people that do the rafting, the art gallery, the restaurant, the local villagers, suppliers and vendors. We are relying on these people. They need us also. It’s a kind of mutual benefit. In the long run everybody gains and that’s how the company thinks. We cannot work in the environment and being selfish. That’s a short term. Maybe in the short term it helps but in the long run you start to get isolated”*. With this understanding in mind, the hotel engages in several CSR practices that bring benefits to the hotel, the society and the environment. Similar to hotel 1, hotel 2 also employs many local people and support local entrepreneurs by sourcing from within the community, as mentioned by the general manager, *“We’ve got 209 employees here, 207 are Balinese and we are the only two foreigners”*. Partnership with the local farmers is also practised by hotel 2. The hotel assists the farmers to cultivate rosela and cashew nut on dry and unproductive lands. By doing so, the hotel improves the economy of the local farmers and at the same time saves significant amount of money by buying produces from the local

farmers instead of importing from other areas. In terms of contribution in promoting health and well-being, the hotel is committed to regularly conducting events to raise money for cancer research in Indonesia, *“Every year we do run to collect money to support research on cancer in Indonesia”*

To sum-up, hotel 2 contributes in promoting the UNSDGs, particularly combating poverty, promoting decent work and economic growth, good health and well-being, and minimising the impact of climate change by employing the locals, supporting the local entrepreneurs, assisting the local farmers to cultivate high value produces and raising money for cancer research.

#### 4.4. Case 3

Hotel 3 is a seaside resort in Manggis, nestled between the sea and Mount Agung. Unlike hotel 1 and hotel 2, the management of hotel 3 did not explicitly acknowledge the importance of living in harmony with the locals and the environment to the success of hotel operation in the long-run. Even though it is not explicitly acknowledged, the hotel conducts various practices to maintain good relationship with the locals and to preserve the environment. As well as hotel 1 and 2, hotel 3 also employs many local people, supports local entrepreneurs, promotes health and well-being, supports local kindergartens and uses eco-friendly products.

Hotel 3 has 2 unique programs related to the effort to preserve the natural environment, namely: green-bank initiative and coral-reef conservation program. In the green-bank initiative, the hotel educates the locals to do reduce, reuse and recycle their own wastes. The hotel also assists the villagers to make handicrafts from recycle materials and then sells their products in the hotel. The general manager explained, *“We train the locals to create handicrafts from recycle papers. We are also committed to promote and sell their handicrafts through all hotel chains”*. By doing so, the hotel could maintain the cleanliness of the hotel environment and obtains support from the locals. Hotel 3 has high concern on preserving the coral-reefs, as diving and snorkeling program is the hotel’s most favourite tour program. To align business and environmental concern, hotel 3 invites their guests to participate in the coral-reefs conservation program while enjoying diving and snorkeling.

#### 5. Conclusions

This paper shows that the United Nation Sustainable Development Goals (UNSDGs) could be effectively promoted through Corporate Social Responsibility Practices (CSRPs). Analysis of the three cases of big rural hotels in Bali – Indonesia reveals that the hotels could significantly contribute to the effort to combat poverty, to achieve zero hunger, to promote good health and well-being, to promote quality education, to promote decent work and economic growth, to minimise the impact of climate change, and to preserve life below water by engaging in CSR practices. Interestingly, by engaging in certain CSR practices the three hotels could align their business and social goals. This paper focuses on the private sectors contribution only in reaching the UNSDGs. To be more effective, efforts to promote the UNSDGs need to involve many parties, such as government, academia, NGOs and civil society. Future research could explore further how various parties promoting the UNSDGs.

#### References

- [1] Bowen, H.R., *Social Responsibilities of the Businessman*. 1953, New York: Harper and Row.
- [2] Davis, K., *Understanding the Social Responsibility Puzzle: What Does the Businessmen Owe to Society?* *Business Horizons*, 1967. 10: p. 45-50.
- [3] Preston, L.E. and J.E. Post, *Private Management and Public Policy: The Principle of Public Responsibility*. 1975, Englewood Cliffs, NJ: Prentice Hall.
- [4] Porter, M.E. and M.R. Kramer *The link between competitive advantage and corporate social responsibility*. *Harvard Business Review*, 2006. 1-13.
- [5] Porter, M.E. and C. Van Der Linde, *Green and Competitive*. *Harvard Business Review* 1995. 73 (5): p. 120-134.
- [6] Dahlsrud, A., *How Corporate Social Responsibility is Defined: An Analysis of 37 Definitions*. *Corporate Social Responsibility and Environmental Management*, 2008. 15: p. 1-13.
- [7] Gokulsing, R.D., *CSR matters in the development of Mauritius*. *Social Responsibility Journal*, 2011. 7(2): p. 218-233.
- [8] Creswell, J.W., *Qualitative inquiry and research design*. 2nd ed. *Choosing among five approaches*. 2007, Thousand Oaks, California: Sage publication.
- [9] Reimann, F., et al., *Local Stakeholders and Local Legitimacy: MNEs' Social Strategies in Emerging Economies*. *Journal of International Management* 2012. 18: p. 1-17.

- [10] BPSIndonesia. Growth of Tourism and National Transportation December 2014. 2015 [cited 2015; Available from: [http://www.bps.go.id/website/brs\\_ind/brsInd-20150202181818.pdf](http://www.bps.go.id/website/brs_ind/brsInd-20150202181818.pdf).

# **Session of Pure and Applied Science**

# Diversity of birds in Hlawga Park, Republic of the Union of Myanmar

Aye Thant Zin<sup>1</sup>, San San Myint<sup>2</sup>, Myitzu Thinn Aung<sup>2</sup>, Khun Aung Naing Oo<sup>2</sup>,  
Kajornsak Jaiyawat<sup>3</sup>, Chanatip Vongpraramat<sup>3</sup> and Pongsarun Junshum<sup>1,3,\*</sup>

<sup>1</sup>Department of Zoology, Mawlamyine University, Mawlamyine, Republic of the Union of Myanmar

<sup>2</sup>Department of Zoology, University of Yangon, Yangon, Republic of the Union of Myanmar

<sup>3</sup>Department of Biology, Faculty of Science and Technology, Thepsatri Rajabhat University, Lopburi, 15000, Thailand

## Abstract

Hlawga Park, 22 miles (35 km) north of Yangon was chosen as study site. This study lasted from June 2014 to May 2015. Twenty five study sites were selected for record the bird species. Point count method was utilized to study the birds. One hundred and twenty nine species belonging to 45 families of 17 orders were recorded during the study period. Of these recorded species 99 species were terrestrial birds and 30 species were waterbirds. In the recorded waterbirds, Ciconiformes was the largest order with 10 species and Passeriformes was the largest order comprising 66 species in the terrestrial birds. In these 27 species were migratory species and 102 species were resident. Shannon Weiner Diversity Index was 2.21, Simpson's index was 0.72, Shannon evenness was 0.46 respectively. Number of bird species was largest in November and smallest in July. Species number of birds gradually declined in monsoon. In present study, maximum observed species were *Dendrocygna javanica*, *Anastomus oscitans*, *Anas poecilorhyncha* and *Garrulax pectoralis*. In total 129 bird species comprised one endemic species, three near-threatened and one endangered were identified.

**Keywords:** Diversity of birds, Hlawga Park, Diversity Index

## 1. Introduction

Myanmar has been wildly regarded as one of the biodiversity richest countries in the Asia and Pacific Region. Biodiversity is very special for our welfare since it is the major component of life supporting system. With extraordinary tropical variation, there is an unusual ecological diversity and these ecosystems are home to numerous species of fauna and flora. Myanmar supports at least 1,096 bird species, a greater diversity than any other country in mainland Southeast Asia. Despite its high species richness, Myanmar's avifauna contains six national endemic species: Hooded Treepie (*Crypsirina cucullata*), White-browed Nuthatch (*Sitta victoriae*), White-throated Babbler, (*Turdoides gularis*), Burmese Bushlark (*Mirafra microptera*), Jerdon's Minivet (*Pericrocotus albifrons*) and Burmese Tit (*Aegithalos sharpie*) [1]. Four hundred and thirty-three species of birds are recorded in Yangon. In these fourteen species are globally threatened and one species are introduced from other place [2].

## 2. Materials and Methods

**2.1 Study Area:** Hlawga Park is situated in 17°00'17"N 96°06'44"E. It is a National Park located in Mingaladon, Yangon Division, Myanmar. It is 22 miles (35 km) north of Yangon. The area of the park is 623-hectare, includes Wildlife Park, 313 hectare, a mini-zoo, 25-hectare and a buffer zone, 267-hectare. First established as an Environmental Education Center in 1982, the National Park is a popular day-trip destination with Yangonites and ecotourists [3].

The Hlawga Park is in coastal Yangon Division, and has a monsoonal climate. Annual average rainfall is about 240 cm most of which is received between late May and October. The coolest months are from November to February (average high: 32°C and average low: 18°C) and the hottest months are from March to May (average high: 37°C and average min: 24°C). The mean relative humidity is 87%. The vegetation type of Hlawga Park is Semi-evergreen forests, Mixed deciduous forests and Swamp forests [3].

**2.2 Study period:** This study was conducted from June 2014 to May 2015. Twenty five study sites were selected for record the bird species. Data records were taken starting from 6:00 am and continued until 11:00 am. Species abundance and population sizes of the birds were noted on monthly basis using point count method. Point count method was conducted [4].

To establish a representative collection of Myanmar indigenous wild life species of birds, and to measure the richness, evenness and diversity of bird species, Hlawga Park is selected as study site.

\* Corresponding author; e-mail: pjunshum@gmail.com



### 2.3 Methodology:

**Point count:** Point count method was utilized to study the birds in Car parking, Gate 1, Gate 4, Gate 6, Gate 9, Kan Tha ya, Dam 1, Dam 4, Dam 5, Dam7, Dam 8, Lake near Dam 7, plain near Dam 7, Picnic site 1, Picnic site 2, Picnic Site 3, Picnic Site 4, feeding place 1, feeding place 2, Lake in Buffer Zone, Buffer Zone , Log cabin 1, Log cabin 2, mini Zoo, and other place. When a bird is spotted, size, color, behavior, call and time were recorded [5, 6].

**Shannon-Weiner Index:** Species evenness, richness, and diversity indices as Shannon-Weiner [7] and Simpson Index were used to evaluate the bird species diversity [8]. The value of Shannon-Weiner Diversity Index usually falls between 1.5 and 3.5, only rarely it surpasses 4.5. A value near 4.6 would indicate that the numbers of individuals are evenly distributed between all the species. Equitability or evenness index value was computed using Shannon's equitability index (J') method [9].

### 3. Results and discussion

One hundred and twenty nine species belonging to 45 families of 17 orders were recorded during the study period. Of these recorded species 99 species were terrestrial birds and 30 species were waterbirds. In the recorded waterbirds, Ciconiformes was the largest order with 10 species and Passeriformes was the largest order comprising 66 species in the terrestrial birds. In these 27 species were migratory species and 102 species were resident [5,6].

**Table 1** Bird species recorded during the period of study

No.	Common name	R / M	Scientific name	Family	Order
1	Quail	R	<i>Coturnix</i> sp.	Phasianidae	Galliformes
2	Red Junglefowl	R	<i>Gallus gallus</i>	Phasianidae	Galliformes
3	Green Peafowl	R	<i>Pavo muticus</i>	Phasianidae	Galliformes
4	Lesser Whistling-Duck	R	<i>Dendrocygna javanica</i>	Anatidae	Anseriformes
5	Spot-billed Duck	R	<i>Anas poecilorhyncha</i>	Anatidae	Anseriformes
6	Cotton Pygmy-goose	R	<i>Nettapus coromandelianus</i>	Anatidae	Anseriformes
7	Little Grebe	R	<i>Tachybaptus ruficollis</i>	Podicipedidae	Podicipediformes
8	Lineated Barbet	R	<i>Megalaima lineata</i>	Megalaimidae	Piciformes
9	Coppersmith Barbet	R	<i>M. haemacephala</i>	Megalaimidae	Piciformes
10	Green Bee-eater	R	<i>Merops orientalis</i>	Meropidae	Coraciiformes
11	Blue-tailed Bee-eater	R	<i>M.philippinus</i>	Meropidae	Coraciiformes
12	Chestnut -headed Bee-eater	R	<i>M. leschenaulti</i>	Meropidae	Coraciiformes
13	White-throated Kingfisher	R	<i>Halcyon smyrensis</i>	Alcedinidae	Coraciiformes
14	Black capped Kingfisher	R	<i>Halcyon pileata</i>	Alcedinidae	Coraciiformes
15	Drongo Cuckoo	R	<i>Surniculus lugubris</i>	Cuculidae	Cuculiformes
16	Indian Cuckoo	R	<i>Coccyz micropterus</i>	Cuculidae	Cuculiformes
17	Plaintive cuckoo	R	<i>Cacomantis merulinus</i>	Cuculidae	Cuculiformes
18	Violet Cuckoo	R	<i>Chrysococcyx xanthorhynchus</i>	Cuculidae	Cuculiformes
19	Asian Koel	R	<i>Eudynamis scolopacea</i>	Cuculidae	Cuculiformes
20	Green-billed Malkoha	R	<i>Phaenicophaeus tristis</i>	Cuculidae	Cuculiformes
21	Greater Coucal	R	<i>Centropus sinensis</i>	Cuculidae	Cuculiformes
22	Dollarbird	R	<i>Eurystomus orientalis</i>	Coraciidae	Coraciiformes
23	Grey headed Parakeet	R	<i>Psittacula finchii</i>	Psittacidae	Psittaciformes

**Table 1 (continued)** Bird species recorded during the period of study

No.	Common name	M/R	Scientific name	Family	Order
24	Blossom-headed Parakeet	R	<i>Psittacula roseata</i>	Psittacidae	Psittaciformes
25	Asian Palm swift	R	<i>Cypsiurus balasiensis</i>	Apodidae	Apodiformes
26	House Swift	R	<i>Apus affinis</i>	Apodidae	Apodiformes
27	Asian barred Owlet	R	<i>Glaucidium cuculoides</i>	Strigidae	Strigiformes
28	Green Imperial Pigeon	R	<i>Ducula aenea</i>	Columbidae	Columbiformes
29	Mountain Imperial Pigeon	R	<i>D. badia</i>	Columbidae	Columbiformes
30	Orange-breasted Green Pigeon	R	<i>Treron bicincta</i>	Columbidae	Columbiformes
31	Thick-billed Green Pigeon	R	<i>T. curvirostra</i>	Columbidae	Columbiformes
32	Spotted Dove	R	<i>Streptopelia chinensis</i>	Columbidae	Columbiformes
33	Red collared Dove	R	<i>S. tranquebarica</i>	Columbidae	Columbiformes
34	Common Moorhen	R	<i>Gallinula chloropus</i>	Rallidae	Gruiformes
35	Common Coot	R	<i>Fulica atra</i>	Rallidae	Gruiformes
36	White-breasted Waterhen	R	<i>Amaurornis phoenicurus</i>	Rallidae	Gruiformes
37	Bronze-winged Jacana	R	<i>Metopidius indicus</i>	Jacanidae	Charadriiformes
38	Green Sandpiper	M	<i>Tringa ochropus</i>	Charadriidae	Scolopacidae
39	Common Sandpiper	M	<i>Actitis hypoleucos</i>	Charadriidae	Charadriiformes
40	Curlew Sandpiper	M	<i>Calidris ferruginea</i>	Charadriidae	Charadriiformes
41	Black-winged Stilt	M	<i>Himantopus himantopus</i>	Recurvirostridae	Charadriiformes
42	Little ringed Plover	M	<i>Charadrius dubius</i>	Charadriidae	Charadriiformes
43	Red –wattled Lapwing	R	<i>Vanellus indicus</i>	Charadriidae	Charadriiformes
44	Osprey	M	<i>Pandion haliaetus</i>	Pandionidae	Falconiformes
45	Crested Serpent Eagle	R	<i>Spilornis cheela</i>	Accipitridae	Falconiformes
46	Black Kite	R	<i>Milvus migrans</i>	Accipitridae	Falconiformes
47	Shikra	R	<i>Accipiter badius</i>	Accipitridae	Falconiformes
48	Oriental Honey Buzzard	R	<i>Pernis ptilorhynchus</i>	Accipitridae	Falconiformes
49	Little Egret	R	<i>Egretta garzetta</i>	Ardeidae	Ciconiformes
50	Purple Heron	R	<i>Ardea purpurea</i>	Ardeidae	Ciconiformes
51	Great Egret	R	<i>Casmerodius albus</i>	Ardeidae	Ciconiformes
52	Intermediate Egret	R	<i>Mesophoyx intermedia</i>	Ardeidae	Ciconiformes
53	Cattle Egret	R	<i>Bubulcus ibis</i>	Ardeidae	Ciconiformes
54	Chinese Pond Heron	R	<i>Ardeola bacchus</i>	Ardeidae	Ciconiformes
55	Black -crowned Night-Heron	R	<i>Nycticorax nycticorax</i>	Ardeidae	Ciconiformes

**Table 1 (continued)** Bird species recorded during the period of study

No.	Common name	M/R	Scientific name	Family	Order
56	Oriental Darter	R	<i>Anhinga melanogaster</i>	Phalacrocoracidae	Pelecaniformes
57	Little Cormorant	R	<i>Phalacrocorax niger</i>	Phalacrocoracidae	Pelecaniformes
58	Indian Cormorant	R	<i>P. fuscicollis</i>	Phalacrocoracidae	Pelecaniformes
59	Glossy Ibis	R	<i>Plegadis falcinellus</i>	Threskiornithidae	Ciconiformes
60	Spot-billed Pelican	R	<i>Pelecanus philippensis</i>	Pelecanidae	Pelecaniformes
61	Asian Openbill	R	<i>Anastomus oscitans</i>	Ciconiidae	Ciconiformes
62	Woolly-necked Stock	R	<i>Ciconia episcopus</i>	Ciconiidae	Ciconiformes
63	Blue winged Pitta	R	<i>Pitta moluccensis</i>	Pittidae	Passeriformes
64	Brown Shrike	M	<i>Lanius cristatus</i>	Laniidae	Passeriformes
65	Gray -backed Shrike	M	<i>L. tepbronotus</i>	Laniidae	Passeriformes
66	Black Drongo	M	<i>Dicrurus macrocercus</i>	Dicruridae	Passeriformes
67	Ashy drongo	M	<i>D. leucophaeus</i>	Dicruridae	Passeriformes
68	Greater Racket-tailed Drongo	R	<i>D. paradiseus</i>	Dicruridae	Passeriformes
69	Lesser Racket-tailed Drongo	R	<i>D. remifer</i>	Dicruridae	Passeriformes
70	Spangle Drongo	R	<i>D. bottentottus</i>	Dicruridae	Passeriformes
71	Crow- billed drongo	M	<i>D. annectans</i>	Dicruridae	Passeriformes
72	Bronze Drongo	R	<i>D. aeneus</i>	Dicruridae	Passeriformes
73	Racket-tailed Treepie	R	<i>Crypsirina temia</i>	Corvidae	Passeriformes
74	House Crow	R	<i>Corvus Splendens</i>	Corvidae	Passeriformes
75	Large-billed Crow	R	<i>C. macrorhynchos</i>	Corvidae	Passeriformes
76	Black-naped Oriole	M	<i>Oriolus chinensis</i>	Oriolidae	Passeriformes
77	Slender-billed Oriole	R	<i>O. tenuirostris</i>	Oriolidae	Passeriformes
78	Common Iora	R	<i>Aegithina tiphia</i>	Irenidae	Passeriformes
79	Rosy minivet	R	<i>Pericrocotus roseus</i>	Campephagidae	Passeriformes
80	Swinhoe's minivet	M	<i>P. cantonensis</i>	Campephagidae	Passeriformes
81	Ashy minivet	M	<i>P. divaricatus</i>	Campephagidae	Passeriformes
82	Black -naped monarch	M	<i>Hypothymis azurea</i>	Muscicapidae	Passeriformes
83	Asian browned Flycatcher	M	<i>Muscicapa dauurica</i>	Muscicapidae	Passeriformes
84	Brown -streaked Flycatcher	R	<i>M. williamsoni</i>	Muscicapidae	Passeriformes
85	Taiga Flycatcher	M	<i>Ficedula parva</i>	Muscicapidae	Passeriformes
86	Grey-headed Canary Flycatcher	R	<i>Culicicapa ceylonensis</i>	Muscicapidae	Passeriformes
87	Orange headed Thrush	R	<i>Zootbera citrina</i>	Muscicapidae	Passeriformes
88	Tickel's Blue Flycatcher	R	<i>Cyornis tickelliae</i>	Muscicapidae	Passeriformes
89	Blue-throated Flycatcher	R	<i>C. rubeculoides</i>	Muscicapidae	Passeriformes

**Table 1 (continued)** Bird species recorded during the period of study

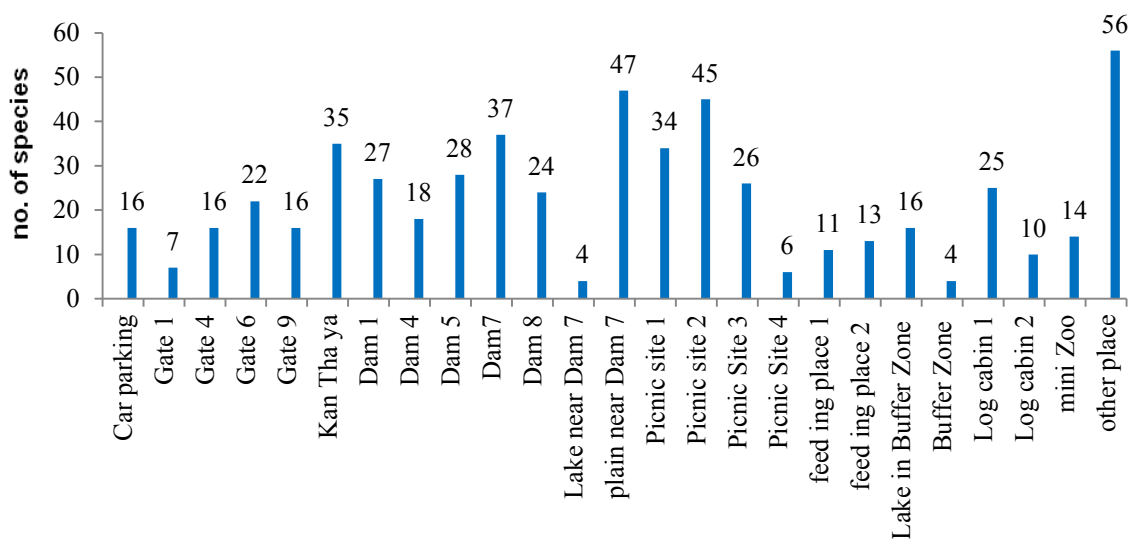
No.	Common name	R/ M	Scientific name	Family	Order
90	Oriental magpie Robin	R	<i>Copsychus saularis</i>	Turdidae	Passeriformes
91	White-rumped Shama	R	<i>C. malabaricus</i>	Turdidae	Passeriformes
92	Chestnut-tailed Starling	R	<i>Sturnus malabaricus</i>	Sturnidae	Passeriformes
93	Common myna	R	<i>Acridotheres tritis</i>	Sturnidae	Passeriformes
94	Jungle myna	R	<i>A. fuscus</i>	Sturnidae	Passeriformes
95	White-vented myna	R	<i>A. cinereus</i>	Sturnidae	Passeriformes
96	Crested Myna	M	<i>A. cristatallus</i>	Sturnidae	Passeriformes
97	Barn Swallow	M	<i>Hirundo rustica</i>	Hirundinidae	Passeriformes
98	Black-winged cuckoo-shrike	R	<i>Coracina melaschistos</i>	Campephagidae	Passeriformes
99	Black-headed Bulbul	R	<i>Pycnonotus atriceps</i>	Pycnonotidae	Passeriformes
100	Black-crested Bulbul	R	<i>P. melanicterus</i>	Pycnonotidae	Passeriformes
101	Red-whiskered Bulbul	R	<i>P. Jocosus</i>	Pycnonotidae	Passeriformes
102	Red-vented Bulbul	R	<i>P. cafer</i>	Pycnonotidae	Passeriformes
103	Stripe-throated Bulbul	R	<i>P. finlaysoni</i>	Pycnonotidae	Passeriformes
104	Streak eared Bulbul	R	<i>P. blanfordi</i>	Pycnonotidae	Passeriformes
105	Brown Prinia	R	<i>P. polychroa</i>	Pycnonotidae	Passeriformes
106	Plain Prinia	R	<i>Prinia inornata</i>	Sylviidae	Passeriformes
107	Common Tailorbird	R	<i>Orthotomus sutorius</i>	Sylviidae	Passeriformes
108	Dark-necked Tailorbird	R	<i>O. atrogularis</i>	Sylviidae	Passeriformes
109	Arctic Warbler	M	<i>Phylloscopus borealis</i>	Sylviidae	Passeriformes
110	Dusky Warbler	M	<i>Phylloscopus fuscatus</i>	Sylviidae	Passeriformes
111	Two-barred Greenish Warbler	M	<i>P. plumbeitarsus</i>	Sylviidae	Passeriformes
112	White crested Laughing Thrush	R	<i>Garrulax leucolophus</i>	Leoithrichidae	Passeriformes
113	Greater Necklaced Laughing Thrush	R	<i>G. pectoralis</i>	Leoithrichidae	Passeriformes
114	Lesser Necklaced Laughingthrush	R	<i>G. monileger</i>	Leoithrichidae	Passeriformes
115	Abbott's Babbler	R	<i>Malacocinla</i>	Pellorneidae	Passeriformes
116	Puff throated Babbler	R	<i>Pellorneum ruficeps</i>	Pellorneidae	Passeriformes
117	White-throated Babbler	R	<i>Turdoides gularis</i>	Timallidae	Passeriformes
118	Scarlet-backed Flowerpecker	R	<i>Dicaeum cruentatum</i>	Dicaeidae	Passeriformes
119	Ruby-cheeked Sunbird	R	<i>Chalcoparia ingalensis</i>	Nectariniidae	Passeriformes
120	Olive-backed Sunbird	R	<i>Nectarinia Jugularis</i>	Nectariniidae	Passeriformes

**Table 1 (continued)** Bird species recorded during the period of study

No.	Common name	R/ M	Scientific name	Family	Order
121	Purple Sunbird	R	<i>Cinnyris siaticus</i>	Nectariniidae	Passeriformes
122	Paddyfield Pipit	M	<i>Anthus Rufulus</i>	Motacillidae	Passeriformes
123	Olive-backed Pipit	M	<i>A. hodgsoni</i>	Motacillidae	Passeriformes
124	Forest Wagtail	M	<i>Dendronanthus indicus</i>	Motacillidae	Passeriformes
125	White wagtail	M	<i>Motacilla alba</i>	Motacillidae	Passeriformes
126	Grey wagtail	M	<i>M. cinerea</i>	Motacillidae	Passeriformes
127	Eurasian Tree Sparrow	R	<i>Passer Montanus</i>	Ploceidae	Passeriformes
128	Scaley breasted munia	R	<i>Lonchura punctulata</i>	Ploceidae	Passeriformes
129	White rumped munia	R	<i>L. Striata</i>	Ploceidae	Passeriformes

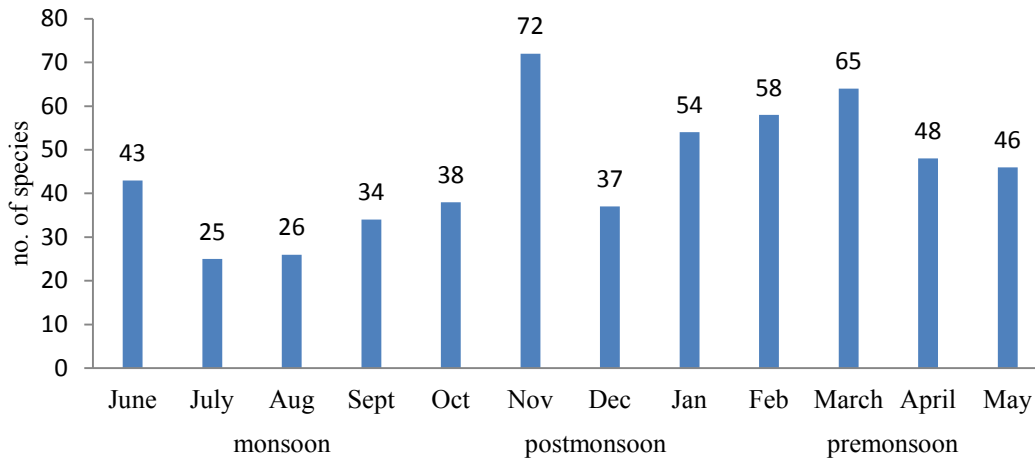
**Remark:** R=resident, M=migrant

One hundred and twenty nine species were monthly recorded. Of these 47 species of birds were sighted in plain near Dam 7 and 45 species were in picnic site 2 (Figure 1). The relative abundance of bird species might be related to the available of food and habitat condition. Whereas Win [10] recorded 147 species of terrestrial birds and 34 species of aquatic birds in her study period at Hlawga Park. Bird watching and counting were conducted monthly for two years starting from 2000 to September 2002. Community structure, resource utilization, habitat preference and seasonal occurrence of birds were also recorded.



**Figure 1** Bids species recorded in each study site in Hlawga Park

Number of bird species was largest in November and smallest in July (Figure 2). Seasonal change of bird species occurred due to the movement of migratory birds. Species number of birds gradually declined in monsoon. These results are in agreement to Paker *et al.* [11] who also observed similar bird species diversity was higher during spring and fall because of the presence of migrating bird species, and found that most bird species were found where trees and shrubs species richness was high.



**Figure 2** Monthly occurrence of bird species in Hlawga Park

Evenness of bird species compare in the month of 2014 June to 2015 May was 0.95 in 2014 June and 0.86 in 2014 August. Shannon Weiner Index value encountered avifauna was estimated to be 3.56 in 2014 June and 3.28 in 2014 August as shown in Table 2.

**Table 2.** Diversity of avian-fauna of Hlawga Park

Month	Diversity index (Shannon Weiner Index)	Equitability index (Evenness j')	species richness index
2014 June	3.56	0.95	0.97
July	2.67	0.83	0.89
August	2.43	0.75	0.80
September	2.45	0.695	0.83
October	2.23	0.62	0.79
November	2.75	0.64	0.80
December	0.84	0.23	0.29
2015 January	1.17	0.29	0.38
February	1.28	0.32	0.54
March	1.55	0.37	0.51
April	2.47	0.64	0.83
May	3.28	0.86	0.94

In present study, maximum observed species were *Dendrocygna javanica* (1490), *Anastomus oscitans* (1000), *Anas poecilorhyncha* (100) and *Garrulax pectoralis* (55). Least observed Species of birds (n=1) were Quail, *Coturnix* sp., Lineated Barbet, *Megalaima lineate*, Large hawk Cuckoo, *Hierococyx sparverioides*, Indian Cuckoo, *Coculus micropterus*, Violet Cuckoo, *Chrysococyx Xanthorhynchus*, Asian Koel, *Eudynamis scolopacea*, Dollarbird, *Eurystomus orientalis*, Blossom-headed parakeet, *Psittacula roseate*, Red collared Dove, *Streptopelia tranquebarica*, Common Moorhen, *Gallinula chloropus*, Common Coot, *Fulica atra*, Bronze-winged Jacana, *Metopidius indicus*, Green Sandpiper, *Tringa ochropus*, Crested Serpent Eagle, *Spilornis cheela*, Black Kite, *Milvus migrans*, Bronze Drongo, *Dicrurus aeneus*, Hooded Treepie, *Crypsirina cucullata*, Asian Browned Flycatcher, *Muscicapa dauurica*, Brown-streak Flycatcher, *M. williamsoni*, Orange headed Thrush, *Zootbera citrina* and Blue-throated Flycatcher, *Cyornis rubeculoides*.

Of these recorded species 102 species were terrestrial birds and 28 species were waterbirds. In the recorded waterbirds, Ciconiformes was the largest order with 10 species and Passeriformes was the largest order comprising 66 species in the terrestrial birds. In these 26 species were migratory species and 104 species were resident. Whereas Zin [12] undertook for two years (July 2002 to June 2004) on species richness and distribution of birds around Yangon area. Eight study sites were selected around Yangon area. Waterbirds of 45 species and 121 species of terrestrial birds were recorded.

In total 129 bird species of Hlawga Park comprised two endemic species, four near-threatened and one endangered were identified according to Avibase - Bird Checklists of the World [2] as shown in Table 3.

**Table 3.** Status of birds in Hlawga Park

Common name	Scientific name	Status
Green Peafowl	<i>Pavo muticus</i>	Endangered
Blossom-headed Parakeet	<i>Psittacula roseata</i>	Near-threatened
Darter	<i>Anhinga melanogaster</i>	Near-threatened
Spot-billed Pelican	<i>Pelecanus philippensis</i>	Extirpated Near-threatened
White-throated Babbler	<i>Turdoides gularis</i>	Endemic

#### 4. Conclusions

One hundred and twenty nine species belonging to 45 families of 17 orders were recorded during the study period. In these 27 species were migratory species and 102 species were resident. Shannon Weiner Diversity Index was 2.21 Simpson's index was 0.72, Shnnon evenness was 0.46 respectively. Number of bird species was largest in November and smallest in July. Species number of birds gradually declined in monsoon. In total 129 bird species comprised one endemic species, three near-threatened and one endangered were identified. However one of the foremost threats to bird population in the Hlawga Park was monkey. Number of monkey population size was found to be high gradually. They destruct bird nests and eat bird eggs. For the stability of species and population of birds, control the monkey population size and protecting natural habitat is to be needed.

#### Acknowledgements

Thanks for the funding support from the bureau of the budget of Thailand.

#### References

- [1] Nyi Nyi Kyaw. National Biodiversity Strategy and Action Plan (2015-2020). The Republic of the Union of Myanmar, Ministry of Environmental Conservation and Forestry; 2015
- [2] Lepage D. Avibase - Bird Checklists of the World, Myanmar [internet]. [cited 2014 December 24]. Available from: <http://avibase.bsc-eoc.org/checklist.jsp?region=MM&list=howardmoore>
- [3] Wikipedia. Hlawga National Park. [internet]. [cited 2014 December 24]. Available from: [https://en.wikipedia.org/wiki/Hlawga\\_National\\_Park](https://en.wikipedia.org/wiki/Hlawga_National_Park)
- [4] Bibby CJ, Bugess ND, Hill DH. Bird Census techniques. London: Acedamic press; 1992.
- [5] King B, woodcock M, Dickinson EC. A field guide to the birds of South east Asia. Hong Kong: South China. Printing Co; 1984.
- [6] Robson C. A field guide to the birds of Thailand and South East Asia. UK: New Holland Publishers; 2008.
- [7] Shannon CE, Weaver W. The Methemathical Theory of Communication. Urbana, Illinois: University of Illinois Press; 1949.
- [8] Simpson EH. Measurement of diversity. *Nature*. 1949;163: 688.
- [9] Bibi F, Ali Z. Measurement of diversity indices of avian communities at Taunsa Barrage Wildlife Sanctuary, Pakistan, *The Journal of Animal and Plant Sciences*. 2013; 23(3): 469-474.
- [10] Win KS. A study of the avian community of Hlawga Wildlife Park. [dissertation]. Zoology Department, Yangon University; 2003.
- [11] Paker Y, Yom-Tov Y, Alon-Mozes T, Barnea A. The effect of plant richness and urban garden structure on bird species richness, diversity and community structure. *Landscape and Urban Planning*. 2014; 122: 186-195.
- [12] Zin AT. Species richness and distribution of avifauna around Yangon area. [dissertation]. Zoology Department, Yangon University; 2005.

# Diversity of Culinary Herbs and Ethnobotany in Hlawga Wildlife Park, Yangon City, Republic of the Union of Myanmar

Peangjai Jianwitchayakul<sup>1,\*</sup>, Soe Soe Aung<sup>2</sup>, Thanda Aye<sup>3</sup>, Mya Zarli<sup>3</sup>, Aye Aye Mu<sup>3</sup> and Zin Mar Myint<sup>3</sup>

<sup>1</sup> Department of Agriculture, Thepsatri Rajabhat University, Thailand

<sup>2</sup> Department of Botany, University of Mandalay, Myanmar

<sup>3</sup> Department of Botany, University of Yangon, Myanmar

## Abstract

This research studies, the diversity of culinary herbs and ethnobotany in Hlawga Wildlife Park in Yangon City, Republic of the Union of Myanmar from July, 2013 to October, 2014. A walking survey of plant diversity and three sizes of exploration blocks of the forest areas are conducted: 400 square meters, 16 square meters and 1 square meter, to collect data on trees, shrubs, climbers, and herbaceous plants. The survey revealed that there are 29 families, 59 genera and 62 species of plants. The plants with density, frequency, dominance, relative density, relative frequency, relative dominance and importance value index are *Microcos paniculata* L., *Gmelina arborea* Roxb., and *Markhamia stipulata* (Wall.) Seem. eg. K. Schum. from the interview with the locals, the results revealed that there are 5 types of plants according to their utilities and some are used for multiple purposes as follows: 1) culinary herbs: 8 families 9 genera 9 species; 2) edible plants: 9 families 16 genera 17 species; 3) medicinal plants: 9 families 11 genera 11 species; 4) construction materials: 17 families 25 genera 25 species; and 5) other purposes: 20 families 30 genera 31 species. The parts of plants which widely used are stems. The parts of plants which widely used for consumption are fruits. Medicinal plants also used in the treatment of hematologic diseases.

**Keywords:** culinary herbs, ethnobotany, Hlawga Wildlife Park

## 1. Introduction

Myanmar, a country with strong cultural heritage, is the largest in South-East Asia. This country is rich in diversified flora and fauna and has unique traditional medicine (TM) culture, which plays an indispensable role in promoting the health care system. A rich heritage of traditional medicine knowledge and the use of plants as medicine still exist in Myanmar which have been inherited from earlier generation [1].

Hlawga Wildlife Park is located in Mingladon Division, Yangon City, Republic of the Union of Myanmar. The area of this park is 1540 acres comprising a wildlife park, a buffer zone and a mini-zoo including other various recreation centers. It is at 17°00'17"N96°06'44"E. There is more than 295 species of plant in Hlawga which is a significant source of medicinal plant supply. [2]

Ethnobotany is the local traditional knowledge of utilizing indigenous plants, such as for foods, medicines and tools which local people have been practicing for a long time. The utilization of plant species found in nature varies in each region [3]. The development of ethnobotany is expected to bring significant economic benefits, and scientific research is required to provide the evidence base for the development of the active ingredients of traditional medicines. Ethnobotany also protects cultural heritage, inspire more studies of traditional medicines, and provides a basis for the discovery of new drug [4].

Today, rapid socioeconomic development, continued deforestation and environment degradation in many parts of Myanmar result depletion of medicinal plants and their associated knowledge. Therefore, the main objective of this study is to assess the diversity of ethnobotany plants used by local people in Yangon for the conservation of biological resources and their sustainable utilization.

---

\* Corresponding author; e-mail: peangjai04@hotmail.com



## 2. Materials and methods

1. The study area is conducted in Hlawga Wildlife Park, Yangon City, Republic of the Union of Myanmar between July, 2013 to October, 2014.

2. To study the ecology of culinary herbs and ethnobotany in 15 exploration blocks using purposive random sampling. The classification and analysis techniques of Kutintara (1998) [5] are applied to analyze the density, frequency, dominance, relative density, relative frequency, relative dominance and importance value index of plants.

3. Collect voucher specimens and transfer to the laboratory for further identification. Plants specimens are identified as belonging to families and species base on Flora of Thailand, Flora of the Malay Peninsular, Flora of British India and specialists.

4. Studies the utilization of plant using the knowledge and wisdom of local citizen and folk medicine by interview and rapid ethnobotanical appraisal (REA).

## 3. Results and discussion

### Ethnobotany plants

The studies in diversity of culinary herbs and ethnobotany in Hlawga Wildlife Park, Yangon City, Republic of the Union of Myanmar revealed that there are 29 families, 59 genera, and 62 species which divided into 6 groups according to life form such as tree, small tree, scandent shrubs, climbing and herb. The useful plants species are mostly trees of 43 species where as 10 are shrubs, 4 are scandent shrubs, 3 are climbing and 1 for shrub and herb (Table 1).

The Hlawga Wildlife Park is dry evergreen forest. The plants with highest density, frequency, relative dominance, relative frequency, dominance, relative dominance and importance value index are *Microcos paniculata* L., *Gmelina arborea* Roxb. and *Markhamia stipulata* (Wall.) Seem. ex K. Schum. The results of interview in the utilization of plants indicated that there are 5 categories as follows; 1) culinary herbs: 8 families 9 genera 9 species; 2) edible plants: 9 families 16 genera 17 species; 3) medicinal plants: 9 families 11 genera 11 species; 4) construction materials: 17 families 25 genera 25 species; and 5) other purposes: 20 families 30 genera 31 species (Table 1). Additionally, some are used for multiple purposes with various parts of plant as root, stem, leaf, flower, fruit, seed, and whole plant (Table 2).

**Table 1** The classification of plant by the utilization of local resident and habit

Category	Taxonomic rank			Number of species categorized by habit					
	Families	Genera	Species	Tree	Small tree	Shrub	Scandent	Climbing	Herb
All ethnobotanical	29	59	62	43	10	1	4	3	1
Culinary Herb	8	9	9	3	3	1	-	1	1
Edible	10	16	17	12	5	-	1	1	1
Medicinal	9	11	11	6	2	2	1	-	-
Construction materials	17	25	25	21	3	-	-	1	-
Other purposes	20	30	31	27	2	1	-	1	-

Notes: Some species overlapped among these five categories

**Table 2** The utilization composition of plant in Hlawga Wildlife Park, Yangon City, Republic of the Union of Myanmar

Category	No. of species of plant parts						
	Root	Stem	Leaf	Flower	Fruit	Seed	Whole plant
Culinary Herb	1	3	6	-	3	-	1
Edible	-	-	2	3	14	-	-
Medicinal	-	5	1	-	3	1	1
Construction materials	-	25	-	-	-	-	-
Other purposes	1	25	-	1	4	-	-

### Culinary Herbs

From the results, there are 8 families, 9 genera 9 species of culinary herbs. The most parts which widely used are leaf (*Combretum latifolium* Blume, *Bridelia tomentosa* Blume., *Tamarindus indica* Linn., *Clatoxylum neriifolium* Kurz, *Microcos paniculata* L., *Premna amplexens* Wall., *Clerodendrum serratum* Spreng.), fruit (*Bridelia tomentosa* Blume., *Microcos paniculata* L.), root (*Combretum latifolium* Blume) and whole plant (*Peperomia pellucida* (L.) H.B.R., *Premna amplexens* Wall.), respectively (Table 3). There are 7 species of culinary herbs that found in Thailand but not utilize as culinary herb in Myanmar (*Spondias mangifera* Willd., *Bridelia ovata* Decne., *Terminalia bellerica* (Gaertn.) Roxb., *Careya arborea* Roxb., *Senna siamea* (Lam.) Irwin & Barneby, *Ziziphus rugosa* Lam., *Bauhinia acuminata* L.) [6-12].

### Edible Plants

From the results, there are 9 families, 16 genera 17 species of edible plants. The most parts which widely used are fruit (*Swintonia floribunda* Griff., *Spondias mangifera* Willd., *Stereospermum neuranthum* Kurz, *Terminalia bellerica* (Gaertn.) Roxb., *Baccaurea flaccida* Muell. Arg., *Bridelia ovata* Decne., *Dalbergia volubilis* Roxb., *Bauhinia acuminata* L., *Flacourtia cataphracta* Roxb., *Neolitsea umbrosa* (Nees) Gamble, *Artocarpus chaplasha* Roxb., *Ficus glomerata* Roxb., *Ziziphus rugosa* Lam., flower (*Radermachera glandulosa* (Blume) Miq., *Markhamia stipulata* (Wall.) Seem. ex K. Schum., *Senna siamea* (Lam.) Irwin & Barneby) and leaf (*Dalbergia lakhonensis* Gagnep, respectively (Table 3). The use of edible plant is closely similar in Thailand [6, 7, 9, 10].

### Medicinal Plants

From the results, there are 9 families, 11 genera 11 species of herbal plants. The most parts which widely used are bark and wood (*Holarrhena pubescens* Wall. ex G. Don, *Dipterocarpus alatus* Roxb., *Salacia chinensis* L., *Celtis tetrandra* Roxb., *Gmelina arborea* Roxb.), fruit (*Holigarna kurzii* King, *Phyllanthus emblica* L., *Bridelia ovata* Decne.), seed (*Cassia fistula* L.), leaf (*Uvaria cordata* Schum. & Thonn.), and whole plant (*Chromolaena odorata* (L.) R.M.), respectively (Table 3). The 18 species are not reported as medicinal plants in Myanmar but applied in Thailand (*Strychnos nux-vomica* L., *Vitex peduncularis* Wall., *Mitragyna rotundifolia* Roxb., *Ficus hispida* Linn. L. f., *Lannea coromandelica* (Houtt.) Merr., *Spondias mangifera* Willd., *Markhamia stipulata* (Wall.) Seem. ex K. Schum., *Garuga pinnata* Roxb., *Schleicera oleosa* (Lour.) Oken, *Diospyros ehretioides* Wall., *Salacia chinensis* L., *Butea monosperma* (Lam.) Kuntze, *Garcinia cowa* Roxb., *Lagerstroemia floribunda* Jack, *Ixora pubirama* Bremek., *Nephelium ramboutan-ake* (Labill.) Leenh., *Celtis tetrandra* Roxb., *Gmelina arborea* Roxb.). The 3 species have same properties *Chromolaena odorata* (L.) R.M., *Bridelia tomentosa* Blume. and *Phyllanthus emblica* L. [8-12].

### Construction materials

From the results, Bignoniaceae (3 genera, 3 species) and Euphorbiaceae are the most common tree for timber in making houses and utensil (Table 3). The 6 species have the same utilization as Thailand (*Dipterocarpus alatus* Roxb., *Neolitsea umbrosa* (Nees) Gamble, *Lagerstroemia floribunda* Jack, *Homalium tomentosum* Benth., *Berrya ammonilla* Roxb. and *Celtis tetrandra* Roxb.) [13].

### Other Purposes

From the results, there are 31 species of plants are used for other purposes. The most common purposes are to sculpture the Buddha images; 3 species (*Syzygium cumini* (L.) Skeels, *Ziziphus rugosa* Lam., *Ixora pubirama* Bremek.), to make dyeing color for textile and hair; 3 species (*Holigarna kurzii* King, *Anogeissus acuminata* Wall., *Engelhardtia spitata* Blume), to make refreshment; 2 species (*Strychnos nux-vomica* L., *Ficus hispida* Linn. L. f.), to make bird food; 1 specie (*Vitex peduncularis* Wall.) and to make fishing bait; 2 species (*Butea parviflora* Roxb., *Strychnos nux-vomica* L.) (Table 3). The use of plant is similar to Thailand except *Holigarna kurzii* King, *Anogeissus acuminata* Wall. and *Engelhardtia spitata* Blum [13].

**Table 3** Ethnobotanical plants in Hlawga Wildlife Park area used by villagers

Families/Species	Habit	Category					Plants/Application
		Cu	Ed	Me	Co	Ot	
<b>Anacardiaceae</b>							
1. <i>Holigarna kurzii</i> King	T			+		+	Stems , barks and leaves for relieve inflammation pain and fever Bark for dye
2. <i>Lannea coromandelica</i> (Houtt.) Merr.	T					+	Wood for firewood
3. <i>Swintonia floribunda</i> Griff.	T		+				Fruits were eaten
4. <i>Spondias mangifera</i> Willd.	T		+				Fruits were eaten
<b>Annonaceae</b>							
5. <i>Uvaria cordata</i> Schum. & Thonn.	S			+			Leaves for catarrh
<b>Apocynaceae</b>							
6. <i>Alstonia scholaris</i> (L.) R. Br.	T	+					Bark for bakery and for carminative and Malaria
7. <i>Holarrhena pubescens</i> Wall. ex G. Don	ST			+			Fruits and fruits for indigestion, dysentery, flatulence
<b>Asteraceae</b>							
8. <i>Chromolaena odorata</i> (L.) R.M.	S			+			Whole plant for wound healing
<b>Bignoniaceae</b>							
9. <i>Markhamia stipulata</i> (Wall.) Seem. ex K. Schum.	T		+			+	Flowers and fruits use for vegetable salad, Wood for constructions
10. <i>Radermachera glandulosa</i> (Blume) Miq.	T		+			+	Flowers and fruits use for vegetable salad, Wood for constructions and firewood
11. <i>Stereospermum neuranthum</i> Kurz	T		+			+	Leaves were eaten, Wood for constructions and fire wood
<b>Burseraceae</b>							
12. <i>Garuga pinnata</i> Roxb.	T					+	Wood for firewood
<b>Combretaceae</b>							
13. <i>Anogeissus acuminata</i> Wall.	T					+	Bark for dye

14. <i>Combretum latifolium</i> Blume	C	+			Leaves were eaten, Roots for anaplastic thyroid cancer
15. <i>Terminalia bellerica</i> (Gaertn.) Roxb.	T			+	Fruits used for fuel oil
<b>Crypteroniaceae</b>					
16. <i>Crypteronia paniculata</i> Blume	T			+ +	Wood for constructions and firewood
<b>Dipterocarpaceae</b>					
17. <i>Dipterocarpus alatus</i> Roxb.	T		+ + +		Barks use for external lotion, Wood for constructions and firewood
<b>Ebenaceae</b>					
18. <i>Diospyros ehretioides</i> Wall.	T			+ +	Wood for constructions and firewood
<b>Euphorbiaceae</b>					
19. <i>Baccaurea flaccida</i> Muell. Arg.	T		+ +		Fruits were eaten, Wood for constructions
20. <i>Bridelia ovata</i> Decne.	ST		+ +		Fruits were eaten, Wood for constructions
21. <i>Bridelia tomentosa</i> Blume.	ST	+		+	Leaves were eaten, Fruit for blood disease, Wood for firewood
22. <i>Phyllanthus emblica</i> L.	T		+		Fruits for common cold, fever, common cold, fever, tonic, stomatic, antipyretic, hair tonic, anti-inflammatory, peptic ulcer, dyspepsia, digestive, wound healing, detoxification and rejuvenation
23. <i>Salacia chinensis</i> L.	Scan S			+	Roots, barks, stems for antidiabetics, rheumatism, skin disease
<b>Fabaceae</b>					
24. <i>Albizia odoratissima</i> (L. f.) Benth.	T			+	Wood for firewood
25. <i>Bauhinia acuminata</i> L.	ST		+		Leaves were eaten
26. <i>Butea monosperma</i> (Lam.) Kuntze	T			+	Wood for firewood
27. <i>Butea parviflora</i> Roxb.	C			+	Fruits were bait for fishing
28. <i>Cassia fistula</i> L.	T			+	Fruits and seeds for constipate
29. <i>Dalbergia laxonensis</i> Gagnep	T		+	+	Young leaves were eaten, Wood for fire wood
30. <i>Dalbergia volubilis</i> Roxb.	C			+	Wood for constructions

31. <i>Senna siamea</i> (Lam.) Irwin & Barneby	T		+		+	Flowers were eaten, Wood for firewood
32. <i>Tamarindus indica</i> Linn	T	+			+	Leaves and fruits were eaten, Fruits for digestive, carminative and laxative Wood for constructions
<b>Flacourtiaceae</b>						
33. <i>Flacourtia cataphracta</i> Roxb.	T		+		+	Fruits were eaten, Wood for constructions
34. <i>Homalium tomentosum</i> Benth.	T				+	Wood for constructions and firewood
<b>Hypericaceae</b>						
35. <i>Clatoxylum neriifolium</i> Kurz	T	+				Leaves were eaten and for laxative
36. <i>Garcinia cowa</i> Roxb.	T				+	Wood for constructions and firewood
<b>Juglandaceae</b>						
37. <i>Engelhardtia spitata</i> Blume	T				+	Barks were used dye for hair and clothes
<b>Lauraceae</b>						
38. <i>Neolitsea umbrosa</i> (Nees) Gamble	ST		+		+	Fruits were eaten, Wood for constructions
<b>Lecythidaceae</b>						
39. <i>Careya arborea</i> Roxb.	T				+	Wood for constructions
<b>Loganiaceae</b>						
40. <i>Strychnos nux-vomica</i> L.	T				+	Roots for brew and baits for fishing
<b>Lythraceae</b>						
41. <i>Duabanga grandiflora</i> Walp.	T				+	Wood for constructions and firewood
42. <i>Lagerstroemia floribunda</i> Jack	T				+	Wood for firewood and charcoal
<b>Moraceae</b>						
43. <i>Artocarpus chaplasha</i> Roxb.	T		+		+	Leaves were eating, Wood for firewood
44. <i>Ficus glomerata</i> Roxb.	T		+		+	Fruits were eaten, Wood for constructions
45. <i>Ficus hispida</i> Linn. L. f.	ST		+		+	Fruits were eaten, Wood for constructions
<b>Myrtaceae</b>						
46. <i>Cleistocalyx nervosum</i> (DC.) Kosterm.	T				+	Wood for firewood
47. <i>Syzygium cumini</i> (L.) Skeels	T				+	Wood used to sculpture the Buddha images
<b>Piperaceae</b>						
48. <i>Peperomia pellucida</i> (L.) H.B.R.	H	+				Whole plant were eaten, Whole plant for asthma

**Rhamnaceae**

49. *Ziziphus rugosa* Lam. ST + + Fruits were eaten, Fruits were used to sculpture the Buddha images

**Rubiaceae**

50. *Ixora pubirama* Bremek. S + Flowers were used for worship to Buddha  
 51. *Mitragyna rotundifolia* Roxb. T + + Wood for constructions and firewood  
 52. *Stephegyne parvifolia* Korth. T + + Wood for constructions and firewood

**Sapindaceae**

53. *Nephelium ramboutanake* (Labill.) Leenh. T + + Fruits were eaten, Wood for constructions

54. *Schleicera oleosa* (Lour.) Oken ST + Fruits for menstrual disorder

**Sterculiaceae**

55. *Pterospermum semisagittatum* Buch.-Ham. T + + Wood for constructions and firewood

**Tiliaceae**

56. *Berrya ammonilla* Roxb. T + Wood for constructions

57. *Microcos paniculata* L. ST + Fruits were eaten, leaves used for wound cleaning lotion

**Ulmaceae**

58. *Celtis tetrandra* Roxb. T + Seeds used for indigestion

**Verbenaceae**

59. *Clerodendrum serratum* Spreng. S + Leaves were eaten and menstrual disorder

60. *Gmelina arborea* Roxb. T + + Flowers for blood disease, Wood for constructions

61. *Premna amplexans* Wall. ST + Leaves were eaten, Whole plants for menstrual disorder

62. *Vitex peduncularis* Wall. T + + Wood for constructions, Fruits for feeding birds

**\*Remark** Cu: Culinary Herbs, Ed: Culinary Plant, Me: Herbal Plant, Co: trees for timber in making houses and utensils, Ot: plants for other purposes

**4. Conclusions**

Myanmar has a rich biodiversity including plant genetic resources which result from altitude and climate also rich heritage of traditional knowledge of the use of plants as medicine. However, only 29 families, 59 genera and 62 species of plants used were recorded in Hlawga Wildlife Park which are lower than expected compares to the rich of natural resources. This might result from the change in the life style of people in new generation. However, the result of study would be benefit as fundamental knowledge to discover new medicine.

**Acknowledgements**

We are very grateful to Bureau of the budget, The Prime Minister's Office for providing research funding. We also thank all the officers in Hlawga Wildlife Park and all participants for their cooperation.

## References

- [1] Awale S, Linn TZ, Than MM, Swe T. The healing art of traditional medicines in Myanmar. *J. Trad Med.* 2006;23: 47-68.
- [2] Wikipedia. Hlawga Wildlife Park. Online resources [cited 2012 July 12]. Available from : <[https://en.wikipedia.org/wiki/Hlawga\\_National\\_Park](https://en.wikipedia.org/wiki/Hlawga_National_Park)>
- [3] Santasombat Y. Biodiversity and indigenous knowledge for sustainable development. Chiang Mai ; Chiang Mai University. 2001. (in Thai)
- [4] Chang N, Luo Z, Li D and Song H. Indigenous uses and pharmacological activity of traditional medicinal in Mouth Taibai, (Online) Available from; <https://doi.org/10.1155/2017/8329817>. 2017.
- [5] Kutintara U. Ecology fundamental basics in Forestry. Bangkok ; Kasetsart University. 1998. (in Thai).
- [6] Thailand Institute of Scientific and Technological Research. Edible plants in Sakaerat I. Bangkok; SE-EDUcation. 2008. (in Thai).
- [7] Thailand Institute of Scientific and Technological Research. Edible plants in Sakaerat II. Bangkok; SE-EDUcation. 2009. (in Thai).
- [8] Phonsena P. Medicinal plants in Khao Hin Son herb garden. Prachinburi; Jetanaromphan. 2007. (in Thai).
- [9] Suksri S, Premcharoen S, Thawatphan C, Sangthongprow S. Ethnobotany in Bung Khong Long Non-Hunting area, Northeast Thailand. *Kasetsart J. (Nat. Sci.)* 39;519-533.
- [10] Pawaputanon Na Mahasarakham P. Plant diversity and ethnobotanical studies at Bung Cheelong fresh water swamp forest. Bangkok; Kasetsart University. 2002. (in Thai).
- [11] Khuankaew S, Srithi K, Tiansawat P, Inta A, Wangpakakapattanawong P. Ethnobotanical study of medicinal plants used by Tai Yai in Northern Thailand. *Journal of Ethnopharmacology* 151, 829-838.
- [12] Inta A. Ethnobotany and crop diversity of Thai Lue and Akha commun lies in upper Northern Thailand and the Xishuangbanna Dai autonomous prefecture, China. Chiang Mai; Chiang Mai University. 2008.
- [13] Veasommai U, Kavduengtian P. Wild tree in Thailand I. Bangkok; H N group. 2004. (in Thai).

## Comparison of Radiation Interaction of Clay and Autoclaved Aerated Concrete Bricks for Radiation Shielding Properties

Kittipong Siengsanoh<sup>1,2\*</sup>, Pruittipol Limkitjaroenporn<sup>2,3</sup>, and Jakrapong Kaewkhao<sup>1,2</sup>

<sup>1</sup>Physics Program, Faculty of Science and Technology, Nakhon Pathom Rajabhat University, Nakhon Pathom, 73000, Thailand

<sup>2</sup>Center of Excellence in Glass Technology and Materials Science (CEGM), Nakhon Pathom Rajabhat University, Nakhon Pathom, 73000, Thailand

<sup>3</sup>Industrial Physics Program, Faculty of Science and Technology, Nakhon Pathom Rajabhat University, Nakhon Pathom, 73000, Thailand

### Abstract

This research studied the radiation interaction of gamma rays with clay and autoclaved aerated concrete bricks. The clay and autoclaved aerated concrete bricks were determined by used gamma rays spectrometer with Compton scattering arrangement for energy variation and analyzed the composition by X-ray Fluorescence Spectroscopy (XRF). The results were determined mass attenuation coefficient values from theory by WinXCom program and experiment respectively. The  $Z_{\text{eff}}$  and the  $N_{\text{el}}$  value were studied for radiation shielding properties of the clay and autoclaved aerated concrete bricks. This research was found that the clay brick had good radiation properties than autoclaved aerated concrete. The experimental values had good agreement with theoretical values.

**Keywords:** autoclaved aerated concrete, clay brick, mass attenuation coefficient

### 1. Introduction

Humans have studied and researched in many ways. To make advances in science and technology Science and technology have a role in human's daily life in both industrial aspect agricultural aspect medical aspect including how to use the ray to preserving food by using solar powered oven ,Nuclear power plant by using radioactive substances ,X-raying ,Radiation destroys cancer cells , MRI or CT Scan and so on[1]. As mentioned Radiation is very useful to humans ,However we have to know and understand the correct way to using because radiation also dangerous to a creature, for example, the explosion of nuclear reactor of Chernobyl nuclear power plant in Ukraine on date 26 April 1986 and Earthquake in Japan on date 11 March 2011 which makes reactor lack of coolant the increasing of heat is making melt and radiation leakage ,but radiation is a particular that unable to be known by the human senses, so it unable to know that you already got radiation into your body or not for the safety a person who concern about radioactive need to find the solution to protect damage from radioactive for reduce risk from receiving radioactive by unreasonable based on the principle from International Radiation Protection Organization ALARA (As Low As Reasonably Achievable) by spend the least time to work Use the longest distance and use radiation shielding for protect the body to gain the excessive radiation standard[2]. Nowadays for prevent X-ray and gamma rays materials used for radiation shielding include lead, concrete, steel[3]. From the principle as said so study Interaction between gamma rays and clay bricks and autoclaved aerated concrete. Which used for housing to study radiation shielding properties [4].

In the present there is a high amount of usage gamma rays. It needs to prevent the danger of gamma rays, coupled with the utilization. The residency or house in the present are made from clay bricks or and autoclaved aerated concrete, hence house is a very important factor for prevent radiation that cannot be avoided such as Living near industrial plants or a place where the source of radiation[5]. This research takes 2 of clay bricks and autoclaved aerated concrete to study interaction between ray with clay bricks and autoclaved aerated concrete.

---

\* Corresponding author; e-mail: first\_f@windowslive.com



## 2. Research objective

2.1 Study radiation interaction between clay and autoclaved aerated concrete bricks for radiation shielding properties.

2.2 Compare the value from experiment and theory values of clay and autoclaved aerated concrete bricks.

## 3. Materials and methods

### 3.1 Measurement of physical properties of samples

The samples, while the measurement of physical properties was measured density of samples following the relation:

$$\rho = \frac{W_a}{W_a - W_b} \rho_b \quad (1)$$

where  $\rho$  is density of sample,  $W_a$  is the weight of sample in air,  $W_b$  is the weight of sample in water and  $\rho_b$  is the density of water.

The analysis of element composition to identify the weight percent in the samples were measured with X-ray fluorescence spectrometer (XRF), Minipal-4, Panalytical. XRF is helpful and accurate analytical instrument widely used for determining element composition in unknown materials. The present weight percent of element composition of samples.

### 3.2 Gamma-ray shielding studies procedure

The shielding properties of samples were calculated with two processes, first: theoretical calculation were calculate with WinXCom program, second: experimental calculation were calculation with the data from experimental procedure.

#### 3.2.1 Theoretical and Experimental calculation

In this part, the data from XRF, weight percent of element composition of each samples were input in WinXCom. The mass attenuation coefficient ( $\mu_m$ ) in unit (cm<sup>2</sup>/g) were calculated with energy range from 223 - 662 keV, based on the rule of mixture:

$$\mu_m = \sum_i w_i (\mu_m)_i \quad (2)$$

where  $W_i$  is the weight fraction of element  $i$  in samples and  $(\mu_m)_i$  is mass attenuation coefficient for individual element  $i$  in samples. The value of mass attenuation coefficient  $\mu_m$  depends on density of the samples, can be used to determine the total atomic cross-section ( $\sigma_{t,a}$ ) following relation:

$$\sigma_{t,a} = \frac{(\mu_m)_{soils}}{N_A \sum_i^n (w_i / A_i)} \quad (3)$$

where  $N_A$  is Avogadro's number and  $A_i$  is the atomic weight of each element  $i$  of the samples. Furthermore, the total cross-section ( $\sigma_{t,el}$ ) is following relation:

$$\sigma_{t,el} = \frac{I}{N_A} \sum_i^n \frac{f_i A_i}{Z_i} (\mu_m)_i = \frac{\sigma_{t,a}}{Z_{eff}} \quad (4)$$

where  $f_i$  is the number of atoms of element  $i$  relative to the number of atom of all elements in samples,  $Z_i$  is the atomic number of element  $i$  in element composition in samples and  $Z_{eff}$  is effective atomic number of samples explain with following relation:

$$Z_{eff} = \frac{\sigma_{t,a}}{\sigma_{t,el}} \quad (5)$$

The electron density ( $N_e$ ) can be defined as the number of electrons per unit mass, and it can be mathematically written as follows [4-9]:

$$N_e = \frac{\mu_m}{\sigma_{t,el}} \quad (6)$$

#### 4. Results and discussion

1. The component element of samples by XRF are result show in table 4.1 and 4.2.

**Table 4.1** clay bricks's component elements

Compound	Si	K	Ca	Ti	Mn	Fe	Zn	Rb	Sr	Zr	Pb
Conc (%)	48.38 7	13.27 5	4.985	3.058	0.476	28.98 8	0.095	0.297	0.055	0.255	0.128

**Table 4.2** autoclaved aerated concrete brick's component elements

Compound	Si	K	Ca	Ti	Mn	Fe	Cu	Zn	Rb	Sr	Zr
Conc (%)	13.77 6	1.073	78.162	0.547	0.098	6.013	0.025	0.039	0.031	0.139	0.098

2. The density of samples by Archimedes is principle with 4-position scales from AND company model HR-200 are show in Table 4.3.

**Table 4.3** The average density of samples

Sample (brick)	Density (g/cm <sup>3</sup> )
AAC	2.5241
Clay	2.5239

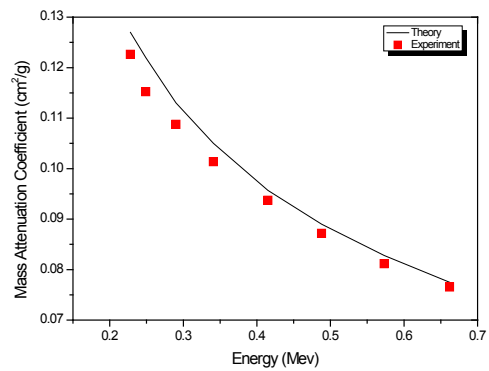
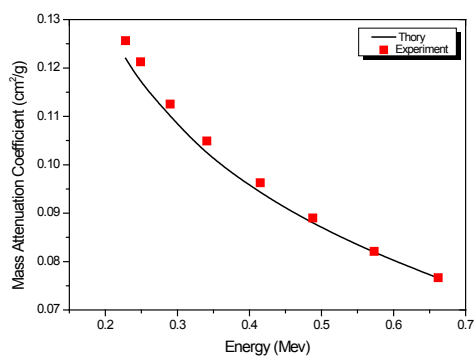
3. The mass attenuation coefficient of clay and autoclaved aerated concrete bricks for theoretical and experimental values are show in Table 4.4, Figure 1 and Table 4.5, Figure 2 respectively.

**Table 4.4** Mass attenuation coefficient,  $\mu_m$  of clay brick

Energy (Mev)	Theoretical value, $\mu_m$ (cm <sup>2</sup> /g)	Experimental value, $\mu_m$ (cm <sup>2</sup> /g)
0.228	1.22E-01	1.21E-01
0.249	1.17E-01	1.17E-01
0.29	1.10E-01	1.09E-01
0.341	1.02E-01	1.02E-01
0.415	9.41E-02	9.41E-02
0.488	8.78E-02	8.74E-02
0.573	8.18E-02	8.11E-02
0.662	7.66E-02	7.61E-02

**Table 4.5** Mass attenuation coefficient of autoclaved aerated concrete

Energy (Mev)	Theoretical value, $\mu_m$ (cm <sup>2</sup> /g)	Experimental value, $\mu_m$ (cm <sup>2</sup> /g)
0.228	1.27E-01	1.27E-01
0.249	1.22E-01	1.19E-01
0.29	1.13E-01	1.12E-01
0.341	1.05E-01	1.04E-01
0.415	9.57E-02	9.57E-02
0.488	8.90E-02	8.86E-02
0.573	8.28E-02	8.21E-02
0.662	7.75E-02	7.71E-02



**Figure 1** Mass attenuation coefficient and energy of clay brick (left) and autoclaved aerated concrete (right)

The mass attenuation coefficient and energy of clay brick and autoclaved aerated concrete were decrease with increasing gamma-rays energy. The two samples had same trend. The clay brick has more mass attenuation coefficient at all of the same gamma-rays energy.

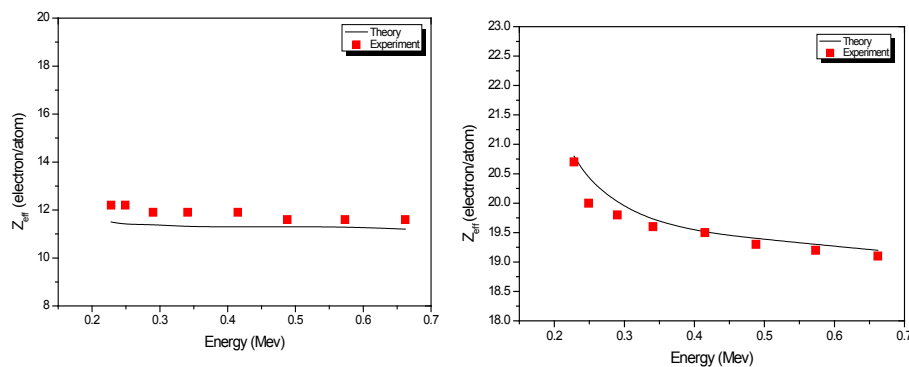
4. The effective atomic number of clay and autoclaved aerated concrete bricks for theoretical and experimental values are show in Table 4.5, Figure 3 and Table 4.6, Figure 4 respectively.

**Table 4.6** Effective atomic number,  $Z_{eff}$  value of the clay bricks.

Energy (Mev)	Theoretical value, $Z_{eff}$ (electron/atom)	Experimental value, $Z_{eff}$ (electron/atom)
0.25	1.14E+01	1.14E+01
0.29	1.14E+01	1.13E+01
0.34	1.13E+01	1.13E+01
0.42	1.13E+01	1.13E+01
0.49	1.13E+01	1.12E+01
0.57	1.13E+01	1.12E+01

**Table 4.7** Effective atomic number,  $Z_{eff}$  value of the bricks of autoclaved aerated concrete.

Energy Mev	Theoretical value, $Z_{eff}$ (electron/atom)	Experimental value, $Z_{eff}$ (electron/atom)
0.23	2.08E+01	2.07E+01
0.25	2.04E+01	2.00E+01
0.29	2.00E+01	1.98E+01
0.34	1.97E+01	1.96E+01
0.42	1.95E+01	1.95E+01
0.49	1.94E+01	1.93E+01



**Figure 2** Effective atomic number,  $Z_{eff}$  value and energy of the clay bricks(left) and autoclaved aerated concrete(right)

The effective atomic number and energy of clay brick has small decrease with increasing gamma-rays energy and autoclaved aerated concrete was clearly decrease with increasing gamma-rays energy. The autoclaved aerated concrete has more effective atomic number at all of the same gamma-rays energy.

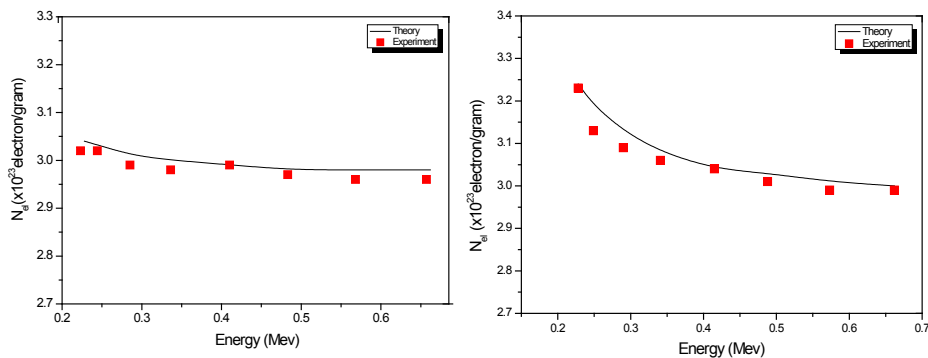
5. The electron density of clay and autoclaved aerated concrete bricks for theoretical and experimental values are show in Table 4.8, Figure 5 and Table 4.9, Figure 6 respectivel

**Table 4.8** Electron density,  $N_{el}$  value of clay bricks.

Energy (Mev)	Theoretical value, $N_{el}$ ( $\times 10^{23}$ electron/gram)	Experimental value, $N_{el}$ ( $\times 10^{23}$ electron/gram)
0.228	3.04	3.02
0.249	3.03	3.02
0.29	3.01	2.99
0.341	3.00	2.98
0.415	2.99	2.99
0.488	2.98	2.97
0.573	2.98	2.96
0.662	2.98	2.96

**Table 4.9** Electron density,  $N_{el}$  value of autoclaved aerated concrete.

Energy (Mev)	Theoretical value, $N_{el}$ ( $\times 10^{23}$ electron/gram)	Experimental value, $N_{el}$ ( $\times 10^{23}$ electron/gram)
0.23	3.24	3.23
0.25	3.19	3.13
0.29	3.13	3.09
0.34	3.08	3.06
0.42	3.04	3.04
0.49	3.03	3.01

**Figure 3** Electron density,  $N_{el}$  value and energy of clay bricks(left) and autoclaved aerated concrete.(right).

The electron density and energy of clay brick has small decrease with increasing gamma-rays energy and autoclaved aerated concrete was clearly decrease with increasing gamma-rays energy. The autoclaved aerated concrete has more electron density at all of the same gamma-rays energy.

## 5. Conclusions

This research has made an experiments for study interaction between radiation of gamma-rays and the clay brick aerated bricks to compare that which one has a best radiation shielding property from 2 samples are clay brick and aerated brick without chemical added then begin the experiments study property of both bricks the result can be concluded that

Property of clay brick and aerated brick from component analysis in both samples of bricks by using spectrometer x-rays energy distribution type. The result of chemical component in samples found high amount of Si, Ca and Fe which are the main components of both bricks, but clay brick has Pb(0.128%) which not found in aerated brick and aerated brick contain Cu(0.025%) which this not available in clay brick.

Density ( $\rho$ ) of clay brick and aerated brick from measurement of density of clay brick and aerated brick sample by used Archimedes' s principle with 4-position scales obtain the density of clay brick is 1.7 density value is 2.5241 and density of aerated brick is 1.8 density value is 2.5239 respective.

Mass attenuation coefficient from measurement of gamma-rays spectrometer then calculate mass attenuation coefficient of experiment and compare from theory which get from program winxcom we found that mass radioactive attenuation coefficient of clay brick and aerated brick are in the energy period 0.228, 0.249, 0.29, 0.341, 0.415, 0.488, 0.573, 0.662 respective. The result shows that clay brick has a better shielding property than aerated brick.

## Acknowledgements

The authors are grateful to thank Prof. L. Gerward, Technical University of Denmark for WinXCom software. J. Kaewkhao, Center of Excellence in Glass Technology and Materials Science (CEGM). I would like to thanks Nakhon Pathom Rajabhat University (NPRU).

## References

- [1] Tamil Nadu, India, Department of Physics, SSN College of Engineering, Kalvakkam, Chennai- 603110, Tamilnadu, India. Department of Physics, Government Arts College, Tiruvanmalai-606603, Tamilnadu, India. Radiation Safety Section, Radiological Safety Division, Indira Gandhi Centre for Atomic Research, Kalpakkam 603102, Measurements of Natural Gamma Radiations and Effects of Physico-Chemical Properties in Samples of Yelagiri Hills, Tamilnadu India with Statistical Approach, *Procedia Earth and Planetary Science*, November 2015, Pages 531 – 538
- [2] David Beamish, British Geological Survey, Enhancing the resolution of airborne gamma-ray data using horizontal gradients, *Journal of Applied Geophysics*, Volume 132, 7 July 2016, Pages 75–86
- [3] Ramon Casanovas, Elena Prieto, Marçal Salvadó, Calculation of the ambient dose equivalent  $H^*(10)$  from gamma-ray spectra obtained with scintillation detectors, *Applied Radiation and Isotopes*, Volume 118, 27 August 2016, Pages 154–159
- [4] N. Karunakara, Assessment of ambient gamma dose rate around a prospective uranium mining area of South India – A comparative study of dose by direct methods and sample radioactivity measurements, *Results in Physics*, Volume 4, 1 March 2014, Pages 20–27
- [5] A.M. El-Khayatt, M.A. Al-Rajhi, Analysis of some lunar sample and rocks samples in terms of photon interaction and photon energy absorption, *Advances in Space Research*, Volume 55, Issue 7, 1 April 2015, Pages 1816-1822.

# A negative binomial-new weighted Lindley distribution for count data and its application to hospitalized patients with diabetes at Ratchaburi hospital, Thailand

Siriporn Samutwachirawong<sup>1,\*</sup>

<sup>1</sup> Section of Statistics, Faculty of Science, Maejo University, San Sai, Chiang Mai 50290, Thailand

## Abstract

The Poisson distribution plays a central role in count data analysis. The most important characteristic of the Poisson distribution is its mean and variance must be equal. In practice, the count data often exhibit the overdispersion, which is the variance is greater than the mean. The negative binomial distribution offers a remedy to this problem. Moreover, the mixed negative binomial distribution is an alternative to count data with overdispersion. The objectives of research are to proposed new distributions for count data, namely, the negative binomial-new weighted Lindley distribution, to derive parameter estimation of the proposed distribution by using the maximum likelihood estimation and to compare efficiencies of the proposed distribution with other distributions. This research found that the negative binomial-new weighted Lindley distribution, obtained by mixing the negative binomial distribution with the new weighted Lindley distribution is another mixed negative binomial distribution that provided an appropriate fit for count data with overdispersion. Some characteristics of the proposed distribution, such as mean, variance, the coefficient of skewness and kurtosis are derived. Finally, application of the proposed distribution for the number of hospitalized patients with diabetes at Ratchaburi hospital, Thailand is presented.

**Keywords:** overdispersion, count data analysis, mixed negative binomial distribution, new weighted Lindley distribution

## 1. Introduction

The count data are non-negative integers, such as the number of hospitalizations, the number of H5N1 outbreaks reported in Thailand, the number of doctors visited per year, and the number of trips taken per year. The most popular method to model count data is the Poisson distribution. The Poisson distribution was introduced by S. D. Poisson. The Poisson distribution should have been named after Bortkiewicz in 1898, the data give the number of soldiers killed by being kicked by a horse each year in each of 14 cavalry corps over a 20-year period. Bortkiewicz showed that those numbers follow the Poisson distribution, mean is equal to variance [1]. Indeed, equidispersion is referred to equality of mean and variance; equidispersion will play a crucial role in further discussion. Besides, there are other categories of dispersion which are overdispersion, variance is greater than the mean and underdispersion, variance is smaller than the mean [2].

Regarding to an importance of dispersion, Greenwood and Yule [3] derived a mixture of Poisson distribution with the mean distributed as a gamma distribution, called the negative binomial (NB) distribution. The NB distribution has become increasingly popular because of a more flexible alternative to the Poisson distribution; especially, when it is doubtful whether the strict requirements, for the Poisson distribution will be satisfied [4]. In addition, the NB distribution can be mixed with other distributions to be an alternative distribution of overdispersed data. It has been shown that the mixed negative binomial distribution provided a better fit to count data compared to the NB distribution, such as the NB-Pareto [5], the NB-inverse Gaussian [6], the NB-Lindley [7], the NB-beta exponential [8], the NB-generalized exponential [9], the NB-crack distribution [10] and the NB-Erlang distribution [11].

The Lindley distribution has been generalized by many researchers in recent years. Ghitany and *et al.* [12] investigated Lindley distribution in the context of reliability analysis. Subsequently, a weighted Lindley (WL) distribution is proposed for modelling survival data. The WL distribution has the property that the hazard rate (mean residual life) function exhibits bathtub (upside-down bathtub) or increasing (decreasing) shapes. Applications of the WL distribution to real survival data are presented. The new weighted Lindley (NWL) distribution was recently introduced by Asgharzadeha and *et al.* [13]. It is a two parameter continuous distribution used in lifetime data. A random variable  $X$  follows the NWL distribution with parameters  $\alpha > 0$  and  $\beta > 0$ . Its the probability density function (pdf) is

---

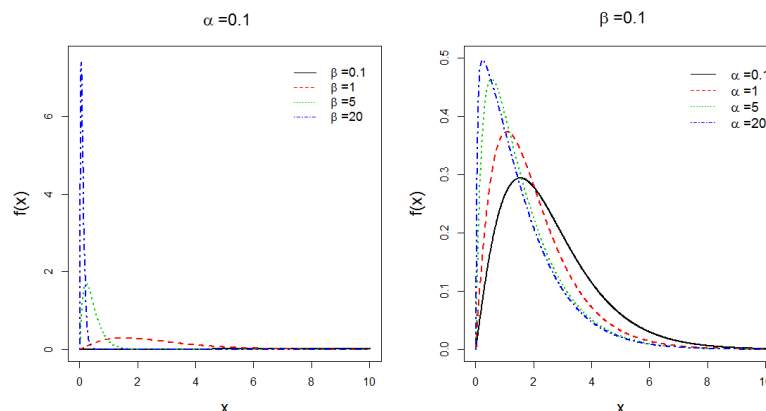
\*Corresponding author; e-mail: siriporn\_sm@mju.ac.th

$$f(x) = \frac{\beta^2(1+\alpha)^2}{\alpha\beta(1+\alpha) + \alpha(2+\alpha)}(1+x)(1-\exp(-\alpha\beta x))\exp(-\beta x), \text{ for } x > 0.$$

Let  $X \sim \text{NWL}(\alpha, \beta)$ , then its moment generating function (mgf) of  $X$  is given by

$$M_X(t) = \frac{\beta^2(1+\alpha)^2}{\alpha\beta(1+\alpha) + \alpha(2+\alpha)} \left\{ \frac{\beta-t+1}{(\beta-t)^2} - \frac{\beta(1+\alpha)-t+1}{\beta(1+\alpha)-t^2} \right\}.$$

Some plots of the NWL pdf with some specified values of  $\alpha$  and  $\beta$  are shown in Figure 1.



**Figure 1** Some pdf plots of the NWL distribution

In this research, a discrete distribution which represents as an alternative distribution for overdispersed count data, namely the negative binomial- new weighted Lindley (NB-NWL) distribution has been developed. The NB-NWL distribution is a mixture of the NB and NWL distributions. Some of the characteristics of the proposed distribution can be studied through factorial moments, e.g., mean, variance, skewness, and kurtosis. The parameters of the proposed distributions are estimated by using the maximum likelihood estimation (MLE). A real data set is the number of hospitalized patients with diabetes at Ratchaburi hospital, Thailand. The proposed distribution is compared performance with Poisson and NB distributions.

## 2. Research objectives

- 2.1 To propose the negative binomial-new weighted Lindley distribution for overdispersed count data.
- 2.2 To derive the parameter estimation of the proposed distributions by using the MLE method
- 2.3 To compare efficiencies of the proposed distribution with other distributions for count data analysis.

## 3. Materials and methods

### 3.1 The materials are as follows

- 1) High performance personal computer for running the coded program.
- 2) R language version 3.4.1 [14] for using in application study.

### 3.2 The methods are as follows

- 1) The pmf and some properties of the NB-NWL distribution will be investigated.
- 2) The estimated of parameters of the NB-NWL distribution will be derived by the MLE method.
- 3) Random variate generation of the NB-NWL distribution is derived.
- 4) Application of the NB-NWL distribution to real data set has been studied by comparing to the

Poisson and NB distributions using the Kolmogorov-Smirnov (K-S) from the dgof package [15] and estimated log-likelihood (LL).

## 4. Results and discussion

In this section presents results of the research. It provides the probability mass function (pmf) of the proposed distribution. Moreover, some characteristics, some plots of the pmf with various values of parameters, parameter estimation, random variate generation, and application of the proposed distribution to real dataset are included in each part.



4.1 The negative binomial- new weighted Lindley distribution

**Definition 4.1** Let  $X|\lambda$  be a random variable following a NB distribution with parameters  $r$  and  $p = \exp(-\lambda)$ ,  $X|\lambda \sim \text{NB}(r, p = \exp(-\lambda))$ . If  $\lambda$  is distributed as the NWL distribution with positive parameters  $\alpha$  and  $\beta$ , denoted by  $\lambda \sim \text{NWL}(\alpha, \beta)$ , then  $X$  is called a NB-NWL random variable.

**Theorem 4.1** Let  $X \sim \text{NB-NWL}(r, \alpha, \beta)$ . The pmf of  $X$  is given by

$$f(x; r, \alpha, \beta) = \binom{r+x-1}{x} \sum_{j=0}^x \binom{x}{j} (-1)^j \frac{\beta^2(1+\alpha)^2}{\alpha\beta(1+\alpha) + \alpha(2+\alpha)} \left\{ \frac{\beta+r+j+1}{(\beta+r+j)^2} - \frac{\beta(1+\alpha)+r+j+1}{[\beta(1+\alpha)+r+j]^2} \right\}, \quad x = 0, 1, 2, \dots$$

where  $\alpha$  and  $\beta > 0$ .

**Proof.** If  $X|\lambda \sim \text{NB}(r, p = \exp(-\lambda))$  and  $\lambda \sim \text{NWL}(\alpha, \beta)$ , then the pmf of  $X$  can be obtained by

$$f(x) = \int_0^\infty f_1(x|\lambda)g(\lambda; \alpha, \beta)d\lambda, \text{ where } f_1(x|\lambda) \text{ is express as}$$

$$\begin{aligned} f_1(x|\lambda) &= \binom{r+x-1}{x} \exp(-\lambda r)(1-\exp(-\lambda))^x, \\ &= \binom{r+x-1}{x} \sum_{j=0}^x \binom{x}{j} (-1)^j \exp(-\lambda(r+j)). \end{aligned}$$

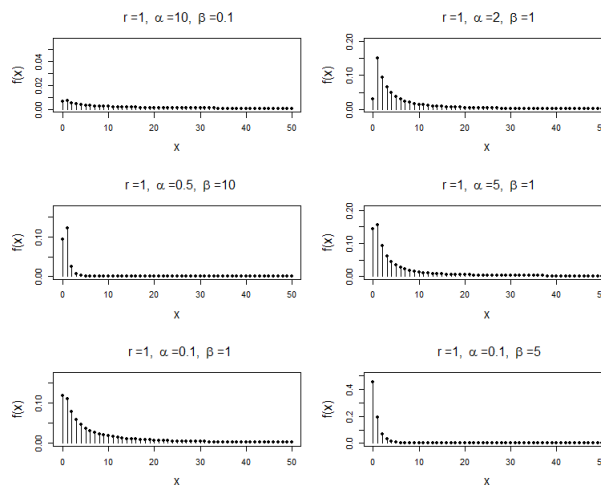
By substituting  $f_1(x|\lambda)$  into  $f(x) = \int_0^\infty f_1(x|\lambda)g(\lambda; \alpha, \beta)d\lambda$ , we obtain

$$\begin{aligned} f(x) &= \binom{r+x-1}{x} \sum_{j=0}^x \binom{x}{j} (-1)^j \left( \int_0^\infty \exp(-\lambda(r+j))g(\lambda; \alpha, \beta)d\lambda \right), \\ &= \binom{r+x-1}{x} \sum_{j=0}^x \binom{x}{j} (-1)^j M_\lambda(-r+j). \end{aligned}$$

Substituting the mgf of the NWL distribution in the equation above, the pmf of the NB-NWL( $r, \alpha, \beta$ ) is given as

$$f(x; r, \alpha, \beta) = \binom{r+x-1}{x} \sum_{j=0}^x \binom{x}{j} (-1)^j \frac{\beta^2(1+\alpha)^2}{\alpha\beta(1+\alpha) + \alpha(2+\alpha)} \left\{ \frac{\beta+r+j+1}{(\beta+r+j)^2} - \frac{\beta(1+\alpha)+r+j+1}{[\beta(1+\alpha)+r+j]^2} \right\}.$$

Figure 2 displays the NB-NWL pmf plots with some specified parameter values of  $\alpha$  and  $\beta$ .



**Figure 2** The pmf of the NB-NWL distribution of some specified values of  $\alpha$  and  $\beta$

#### 4.2 Characteristics of the NB-NWL distribution

Some characteristics of the NB-NWL distribution will be discussed as follows. The factorial moment of the NB-NWL distribution is introduced. Some of the most important structures and characteristics of the NB-NWL distribution can be studied through factorial moments.

**Theorem 4.2** If  $X \sim \text{NB-NWL}(r, \alpha, \beta)$ , the factorial moment of order  $a$  of  $X$  is

$$\mu'_a(X) = \frac{\Gamma(r+a)}{\Gamma(r)} \sum_{j=0}^a \binom{a}{j} (-1)^j \frac{\beta^2(1+\alpha)^2}{\alpha\beta(1+\alpha) + \alpha(2+\alpha)} \left\{ \frac{\beta-a+j+1}{(\beta-a+j)^2} - \frac{\beta(1+\alpha)-a+j+1}{[\beta(1+\alpha)-a+j]^2} \right\}, \quad x = 0, 1, 2, \dots$$

for  $\alpha$  and  $\beta > 0$ .

**Proof.** Gómez and *et al.* [6] showed that the factorial moment of order  $a$  of mixed NB distribution can be expressed in the terms of elementary function by

$$\begin{aligned} \mu'_a(X) &= E_\lambda \left( \frac{\Gamma(r+a)}{\Gamma(r)} \frac{(1-\exp(-\lambda))^a}{\exp(-\lambda a)} \right) \\ &= \frac{\Gamma(r+a)}{\Gamma(r)} E_\lambda (\exp(\lambda) - 1)^a. \end{aligned}$$

Using the binomial expansion of  $(\exp(\lambda) - 1)^a$ , then  $\mu'_a(X)$  can be written as

$$\begin{aligned} \mu'_a(X) &= \frac{\Gamma(r+a)}{\Gamma(r)} \sum_{j=0}^a \binom{a}{j} (-1)^j E_\lambda (\exp(\lambda(a-j))), \\ &= \frac{\Gamma(r+a)}{\Gamma(r)} \sum_{j=0}^a \binom{a}{j} (-1)^j M_\lambda(a-j). \end{aligned}$$

From the mgf of the NWL distribution with  $t = a - j$ , the  $\mu'_a(X)$  is finally given as

$$\mu'_a(X) = \frac{\Gamma(r+a)}{\Gamma(r)} \sum_{j=0}^a \binom{a}{j} (-1)^j \frac{\beta^2(1+\alpha)^2}{\alpha\beta(1+\alpha) + \alpha(2+\alpha)} \left\{ \frac{\beta-a+j+1}{(\beta-a+j)^2} - \frac{\beta(1+\alpha)-a+j+1}{[\beta(1+\alpha)-a+j]^2} \right\}.$$

**Definition 4.2** Let  $X \sim \text{NB-NWL}(r, \alpha, \beta)$ , some properties of  $X$  are as follows

1) The first four moments about zero of  $X$  are

$$\begin{aligned} E(X) &= r(\phi_1 - 1), \\ E(X^2) &= r(r+1)\phi_2 - r(2r+1)\phi_1 + r^2, \\ E(X^3) &= r(r+1)(r+2)\phi_3 - 3r(r+1)2\phi_2 + r(3r^2+3r+1)\phi_1 - r^3, \\ E(X^4) &= r(r+1)(r+2)(r+3)\phi_4 - 2r(r+1)(2r^2+7r+6)\phi_3 \\ &\quad + r(r+1)(6r^2+12r+7)\phi_2 - r(2r+1)(2r^2+2r+1)\phi_1 + r^4. \end{aligned}$$

2) The mean and variance of  $X$  respectively, are

$$\begin{aligned} E(X) &= r(\phi_1 - 1), \\ \text{Var}(X) &= r(r+1)\phi_2 - r(1+r\phi_1)\phi_1. \end{aligned}$$

3) The coefficient of skewness and kurtosis of  $X$  respectively, are

$$\begin{aligned} \text{Skewness}(X) &= [r(r+1)(r+2)\phi_3 - 3r(r+1)(r\phi_1 + 1)\phi_2 \\ &\quad + r(2r\phi_1 + 1)(r\phi_1 + 1)\phi] / [\text{Var}(X)]^{3/2}, \end{aligned}$$

$$Kurtosis(X) = [r(r+1)(r+2)(r+3)\phi_4 - 2r(r+1)(r+2)(2\phi_1+3)\phi_3 + r(r+1)(6r^2\phi_1^2 + 12r\phi_1 + 7)\phi_2 - r(r\phi_1 + 1)(3r^2\phi_1^2 + 3r\phi_1 + 1)\phi] / [Var(X)]^2,$$

where  $\phi_k = \frac{\beta^2(1+\alpha)^2}{\alpha\beta(1+\alpha) + \alpha(2+\alpha)} \left\{ \frac{\beta-k+1}{(\beta-k)^2} - \frac{\beta(1+\alpha)-k+1}{[\beta(1+\alpha)-k]^2} \right\}$ .

### 4.3 Parameter estimation

The parameter estimation for the NB-NWL distribution via the MLE method will be discussed. If  $X \sim \text{NB-NWL}(r, \alpha, \beta)$ , then the likelihood function of parameters  $r, \alpha$  and  $\beta$  can be written as

$$L(r, \alpha, \beta; x_i) = \prod_{i=1}^n \left[ \binom{r+x_i-1}{x_i} \sum_{j=0}^{x_i} \binom{x_i}{j} (-1)^j \frac{\beta^2(1+\alpha)^2}{\alpha\beta(1+\alpha) + \alpha(2+\alpha)} \left\{ \frac{\beta+r+j+1}{(\beta+r+j)^2} - \frac{\beta(1+\alpha)+r+j+1}{[\beta(1+\alpha)+r+j]^2} \right\} \right],$$

consequently, the associated log-likelihood function is

$$\begin{aligned} \mathcal{L} &= \log L(r, \alpha, \beta; x_i) \\ &= \sum_{i=1}^n [\log \Gamma(r+x_i) - \log \Gamma(r) - \log \Gamma(x_i+1)] \\ &\quad + \sum_{j=0}^{x_i} \log \left[ \sum_{j=0}^{x_i} \binom{x_i}{j} (-1)^j \frac{\beta^2(1+\alpha)^2}{\alpha\beta(1+\alpha) + \alpha(2+\alpha)} \left\{ \frac{\beta+r+j+1}{(\beta+r+j)^2} - \frac{\beta(1+\alpha)+r+j+1}{[\beta(1+\alpha)+r+j]^2} \right\} \right]. \end{aligned}$$

The first order conditions for finding the optimal values of the parameters obtained by differentiating the associated log-likelihood function with respect to  $r, \alpha$  and  $\beta$  give rise to the following differential equations

$$\begin{aligned} \frac{\partial \mathcal{L}}{\partial r} &= \sum_{i=1}^n \psi(r-x_i) - n \psi(r) + \sum_{i=1}^n \left( \frac{\sum_{j=0}^{x_i} \binom{x_i}{j} (-1)^j \frac{\partial}{\partial r} B}{\sum_{j=0}^{x_i} \binom{x_i}{j} (-1)^j B} \right), \\ \frac{\partial \mathcal{L}}{\partial c} &= \sum_{i=1}^n \left( \frac{\sum_{j=0}^{x_i} \binom{x_i}{j} (-1)^j \frac{\partial}{\partial c} B}{\sum_{j=0}^{x_i} \binom{x_i}{j} (-1)^j B} \right), \\ \frac{\partial \mathcal{L}}{\partial k} &= \sum_{i=1}^n \left( \frac{\sum_{j=0}^{x_i} \binom{x_i}{j} (-1)^j \frac{\partial}{\partial c} B}{\sum_{j=0}^{x_i} \binom{x_i}{j} (-1)^j B} \right), \end{aligned}$$

where  $\psi(g) = \frac{\Gamma'(g)}{\Gamma(g)}$  is the digamma function and  $B = \frac{\beta^2(1+\alpha)^2}{\alpha\beta(1+\alpha) + \alpha(2+\alpha)} \left\{ \frac{\beta+r+j+1}{(\beta+r+j)^2} - \frac{\beta(1+\alpha)+r+j+1}{[\beta(1+\alpha)+r+j]^2} \right\}$ .

The maximum likelihood estimates  $\hat{r}, \hat{\alpha}$  and  $\hat{\beta}$  for the parameters  $r, \alpha$  and  $\beta$  respectively, are taken by solving iteratively differential equations to zero. These differential equations are not in closed form, a numerical method can be employed to obtain the expectations of them. The MLE solution of  $\hat{r}, \hat{\alpha}$  and  $\hat{\beta}$  can be obtained by solving the resulting equations simultaneously using optim function in R language.

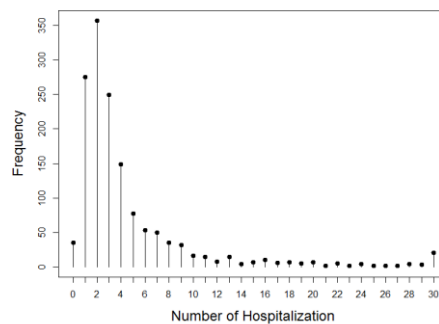
#### 4.4 Random variate generation of NB-NWL distribution

A random variate  $X$  from the NB-NWL( $r, \alpha, \beta$ ), has been generated from following algorithm.

- 1) Generate  $U$  from the uniform distribution,  $U(0,1)$ ,
- 2) Set  $\lambda = -\frac{1}{\beta} \log(1 - U^{1/\alpha})$  from the NWL distribution,  $NWL(\alpha, \beta)$ ,
- 3) Generate  $X$  from the NB( $r, p = \exp(-\lambda)$ ) distribution.

#### 4.5 Applications study of NB-NWL distribution

We illustrated the NB-NWL, NB and Poisson distributions by applying to real data set. The information of hospitalized 1459 cases from ages 55- 90 years old in period 2012 to 2016 of at Ratchaburi hospital, Thailand was used as source of real data. The decision to admit to the hospital should be made if the patient has not responded well to treatment within no more than 4 hours after presentation. A real data set was used to estimate the parameters for the NB-NWL, NB and Poisson distributions using the MLE method. The mean and variance are 4.5456 and 29.6349, respectively. The index of dispersion is 6.5195, indicating that there is high percentage of zeros and the variance is greater than the mean.



**Figure 3** The number of hospitalized patients with diabetes at Ratchaburi hospital, Thailand

The log-likelihood values and the  $p$ -values of K-S test for the discrete goodness of fit test are summarized in Table 1. The expected frequencies of the NB-NWL distribution are close to the observed frequencies, the values of K-S test of NB-NWL distribution is smaller than the values of the K-S test of the Poisson and NB distributions

## 5. Conclusions

This work proposes the new mixed negative binomial distribution, which is called the negative binomial-new weighted Lindley distribution. In particular, some of the most important characteristics of the distribution can be studied through factorial moments, e.g., mean, variance, skewness, and kurtosis. In the application of the NB-NWL distribution, we compare the accuracy of the proposed distribution with the Poisson and NB distributions. The usefulness of the NB-NWL distribution is illustrated by the number of hospitalized patients with diabetes at Ratchaburi hospital, Thailand. We use the log-likelihood and  $p$ -values of the K-S test for the goodness of fit for model selection purpose. Finally, the result of this study show that the NB-NWL distribution provides a better fit compared to the Poisson and NB distributions. Obviously, the NB-NWL distribution is an alternative distribution to the other for count data.

**Table 1** Observed and expected frequencies for number of hospitalized patients with diabetes

No. of hospitalization	No. of cases	Expected value by fitting distribution		
		Poisson	NB	NB-NWL
0	35	261.2574	73.5711	34.3315
1	275	449.3630	155.7058	189.0602
2	357	386.4520	205.2514	171.5407
3	249	221.5659	215.9518	147.2508
4	149	95.2733	198.4813	124.3442
5	77	32.7740	166.5815	104.7453
6	53	9.3952	130.9441	88.5186
7	50	2.3085	97.9537	75.2206
8	35	0.4963	70.4826	64.3310
9	32	0.0949	49.1530	55.3816
10	16	0.0163	33.4063	47.9862
11	15	0.0026	22.2195	41.8357
12	8	0.0004	14.5100	36.6865
13	15	0.0000	9.3271	32.3472
14	4	0.0000	5.9136	28.6669
15	7	0.0000	3.7045	25.5265
16	10	0.0000	2.2959	22.8310
17	6	0.0000	1.4095	20.5048
18	7	0.0000	0.8579	18.4868
19	5	0.0000	0.5182	16.7277
20	7	0.0000	0.3108	15.1872
21	2	0.0000	0.1853	13.8323
22	5	0.0000	0.1098	12.6358
23	2	0.0000	0.0647	11.5752
24	4	0.0000	0.0380	10.6315
25	2	0.0000	0.0222	9.7890
26	2	0.0000	0.0129	9.0345
27	2	0.0000	0.0075	8.3566
28	4	0.0000	0.0043	7.7458
29	3	0.0000	0.0025	7.1940
30+	21	0.0000	0.0014	6.6942
Total	1459			
Parameter estimates		$\hat{\lambda} = 1.72$	$\hat{r} = 4.07$ $\hat{p} = 0.48$	$\hat{r} = 4.15$ $\hat{\alpha} = 0.52$ $\hat{\beta} = 2.01$
log-likelihood		-1140.449	-1014.642	-825.985
K-S test		0.319	0.013	0.018
p-value		<0.001	0.086	0.572

**Acknowledgements**

First, I thankful to Section of Statistics, Faculty of Science, Maejo University. I would like to express a special thanks Dr.Krisana Lanumteang for suggestions and help with the real data set.

## References

- [1] Haight F. **Handbook of the Poisson distribution**. John Wiley and Sons, New York. 1967.
- [2] Rainer W. **Econometric analysis of count data**. Library of congress control, New York. 2008.
- [3] Greenwood M, Yule G. An enquiry into the nature of frequency distributions representative of multiple happenings with particular reference of multiple attacks of disease or of repeated accidents. **Journal of the royal statistical society**. 1920; **83**: 25-279.
- [4] Johnson N, Kemp A, Kotz S. **Univariate discrete distributions**. John Wiley and Sons, New York. 2005.
- [5] Klugman S, Panjer H, Willmot G. **Loss models: from data to decisions**. 3<sup>rd</sup> ed. John Wiley and Sons. 2008.
- [6] G´omez D, Sarabia J, Calder´in E. Univariate and multivariate versions of the negative binomial-inverse Gaussian distributions with applications. **Insurance: mathematics and economics**. 2008; **42** (1): 39-49.
- [7] Zamani H, Ismail N. Negative binomial Lindley distribution and its application. **Journal of mathematics and statistics**. 2010; **6** (1): 4-9.
- [8] Pudprommarat C, Bodhisuwan W, Zeephongsekul P. A new mixed negative binomial distribution. **Journal of applied sciences**. 2011; **12** (17): 1853-1858.
- [9] Aryuyuen S, Bodhisuwan W. The negative binomial-generalized exponential (NB-GE) distribution. **Applied mathematical sciences**. 2013; **7** (22): 1093-1105.
- [10] Saengthong P, Bodhisuwan W. Negative binomial-crack (NB-CR) distribution. **International journal of pure and applied mathematics**. 2013; **84**(3): 213-230.
- [11] Kongrod S, Bodhisuwan W, Payakkapong P. Negative Binomial-Erlang distribution with application. **International journal of pure and applied mathematics**. 2014; **92** (3): 389-401.
- [12] Ghitany ME, Atieh B, Nadarajah S. Lindley distribution and its application. *Mathematics and computers in simulation*. 2008; **78**: 493-506.
- [13] Asgharzadeha A, Hassan SB, Nadarajah S, Sharafia F. A new weighted Lindley distribution with application. **Brazilian journal of probability and statistics**. 2016; **30**(1): 1-27.
- [14] R Core Team. **R: A Language and Environment for Statistical Computing**. R Foundation for Statistical Computing. Vienna, Austria. 2015.
- [15] Arnold BT, Emerson WJ. Nonparametric goodness-of-fit tests for discrete null distributions. **The R journal**. 2011; **3**: 34-39.

# **Session of Electrical Engineering and Technology**

# Investigating Electric Vehicle (EV) Charging Station Locations for Agartala, India

Somudeep Bhattacharjee<sup>1</sup>, Saima Batool<sup>2</sup>, Champa Nandi<sup>1</sup> and Udsanee Pakdeetrakulwong<sup>3,\*</sup>

<sup>1</sup>Tripura University

<sup>2</sup>School of Information Systems, Curtin Business School, Curtin University

<sup>3</sup>Nakhon Pathom Rajabhat University

## Abstract

Selecting the location for installing electric vehicles charging stations is important to ensure EV adoption and also to address some of the inherent risks such as battery cost and degradation, economic risks, lack of charging infrastructure, risky maintenance of EVs, problems of its integration in smart grid, range anxiety, auxiliary loads and motorist attitude. In this article, we investigate these problems by studying three aspects – 1) three types of electrical vehicle charging stations (Level 1, Level 2 and DC), 2) different types of batteries and 3) different types of electric vehicles. We compared and contrasted the features of these charging stations, batteries and EV to identify the best choice for a given scenario. We applied the framework proposed in [1], and used Agartala, India as a case study to identify location for charging stations in and around Agartala suburbs.

**Keywords:** Electric vehicle, charging stations, electric vehicle battery, charging stations location conditions, infrastructure

## 1. Introduction

An electric car is actually an alternative-design automobile that basically uses an electric motor to provide power to the car, with the electricity being provided by a battery. On the other hand, a conventional car does have a lead-acid battery as part of its standard equipment but this battery is used for operating the starter and not providing power to the vehicle. This technology works in this way that the electric vehicle uses a motor just like conventional, internal combustion engine cars. The main difference is that the electric vehicle power supply is derived from its battery-stored electricity and not from the mechanical power derived from burning gasoline. The electric vehicle replaces the traditional gasoline or diesel engine and fuel tank with an electric motor, a battery pack and controllers. The vehicle uses a controller that provides power to the electric motor that uses rechargeable batteries as its energy source. The motor itself can be either AC or DC. The main advantage of electric vehicle is mainly the motor and battery configuration. This allows the vehicle to run more fuel-efficiently. PHEV (plug in hybrid electrical vehicle) is a hybrid vehicle that can be plugged into the power grid for charging the battery. In this vehicle, a medium-capacity battery is available that helps the electrical vehicle in allowing it in all-electric modes, to achieve several kilometers, and acceleration rates and also it help to attain top speeds comparable to those of gasoline-powered vehicles. Examples: Chevrolet Volt (often classified as an E R E V), Ford C-Max and Fusion Energi, Cadillac E L R and Toyota Prius P H E V. On the basis of different types of power trains (or drive trains), hybrid electric vehicles can be classified into three categories: (1) Parallel hybrid, (2) Series hybrid, and (3) Power-split hybrid. Among these, the *parallel hybrid electric vehicle* is commonly adopted. PHEVs are usually consists of an electric motor and an additional ICE for propulsion. This mixed propulsion system helps in enabling PHEVs to be driven in two modes: charge depleting (CD) mode and charge sustaining (CS) mode. When this type of electric vehicles operated in CD mode then it mainly drawn energy from on-board battery packs. If the battery state of charge (SOC) has been depleted to a pre-determined level, PHEVs will then switch to CS mode and utilize the ICE system for further propulsion. When it is operated in CS mode, PHEVs combine both power sources so that it can operate as efficiently as possible. Meanwhile, the controller can monitor the battery SOC level and then maintain it with in a pre-determined band.

---

\* Corresponding author; e-mail: udsanee@webmail.npru.ac.th



## 2. Objectives

Global warming is becoming a major problem and the best way to combat it is to reduce air pollution. Electric vehicles (EVs) are considered a best option to reduce air pollution and making environment safe again. In order to operate, electric vehicles need charging stations at suitable places. If appropriate and recommended places are not chosen then it will decrease the utilization, visibility and effectiveness of a charging station, which results in adoption of traditional carbon-emitting gasoline vehicles and a decrease in EV sales. Hence, it is very essential to carefully select locations for EV charging stations for promotion of EVs and the cause of avoiding global warming.

The main objective of this study is to determine the best locations for installing EV public charging stations in Agartala, India. Our selection for EV charging station location will depend on the set of conditions that have to be met in order to qualify for a place to be established as an EV public charging station. In addition, we will also determine the best type of charging station based on the type and charging duration of the particular EV type. Finally, this research will provide a specific and thorough insight of establishing EV public charging station in growing cities like Agartala, India.

## 3. Research Methodology

The framework proposed by [1], is used as a guideline to assess the implementation of EV charging infrastructure for Agartala city. To achieve this, 3 areas are studied 1) Different types of charging stations, 2) EV types, 3) battery types. First of all, different types of charging stations are studied and compared. Next, various types of EVs are analyzed thoroughly. Moreover, the charging vehicle location selection conditions, infrastructure and the best suitable places in Agartala are selected based on the electric vehicle charging station location selection conditions and the map of Agartala.

### Preliminary Concepts

We know that as the global benefits of a serious energy crisis, alternative energy for sustainable development is renewable energy. The generation of this energy is pollution free and so this is the first choice of many countries of the world like the United States, Japan and Europe and so the development of electric vehicles is a way to save nature and to resolve important issue of planning the national grid. An electrical vehicle requires charging station and so the locations of charging station have to be determined carefully. A charging station is a location where an electric vehicle can be plugged in to have electric charge deposited in to their batteries. They are not chargers, but can be considered as an electrical energy source.

### Different types of charging stations:

There are mainly three types of charging stations which are categorized as Level 1, Level 2 and DC charging stations.

#### LEVEL 1 Charging Station (120 volts and up to 16 amps):

In all electrical vehicles, an on-board Level 1 charger is equipped that can be plugged into any normal power outlet (C S A 5-15R\*). It gives an advantage of not requiring any electrical work, or at least minimizes any installation costs. Table 1 shows the charging time using a Level 1 charger based on distance driven. 12-A charging cable and 120-V outlet is considered. Charging cable rated less than 12A require longer charging times [3].

#### LEVEL 2 Charging Station (240 volts and 12-80 amps):

In this type, the charging time of Level 2 charging stations can be limited by the specifications of the on-board charger and the state of the battery, irrespective of the rated power of the charging station. It is believed that the charger capacity is going to increase in future, for example, Tesla already offers on-board 10 kW and 20 kW chargers. Table 1 shows that level 2 charging stations takes less time to charge as compared to the level 1 charging stations even though the distance traveled is similar. Level 2 charging stations have smart and timeless design. It is simple to use (plug the EV in and let it charge). It helps in reducing energy consumption. In addition, it offers Ethernet network for Radio Frequency Identification (RFI) authorization and vehicle ground monitoring circuit. The cord holder keeps the cord organized and out of the way of parking spaces, sidewalks and streets, etc. One example of this is Schneider EV link Indoor Charging Station, which has ground monitor and user friendly LEDs to display status like charging, detected fault, power etc. It has the capability for automatic recovery and restart after ground fault interrupt or main power loss [1].

DC Fast Charging Station (480 volts and up to 125 amps):

**DC fast-charge stations generally support two standards:**

The North American S A E J 1772 Combo standard and the Japanese J E V S G105-1993\* standard. The configuration of the charging plug and the electrical vehicle socket follows the same basic principle compared to the communication protocol between the charging station and the electrical vehicle but have different standards [1]. Table 1 shows the time required to charge a battery with a 100-km range to 80% of its full capacity.

**Analysis of Different Charging Stations**

Table 1 shows the comparison of different charging stations which are categorized as Level 1, Level 2 and DC charging stations based on electric vehicle distance travelled in km, estimated energy consumption of electric vehicle in kWh, charging station power of electric vehicle in kW, approximate charging time in hour.

**Table 1:** The comparison between different charging stations levels (Adopted from [1])

Different types of charging stations	DISTANCE TRAVELED ( km)	APPROXIMATE ENERGY CONSUMPTION(kWh)	CHARGING STATION POWER(kW)	APPROXIMATE CHARGING TIME(h)
LEVEL 1(120 volts and up to 16 amps)	25	5.2	1.4	4
	50	10.4		8
	100	20.7		15
LEVEL 2 (240 volts and 12-80 amps) for 15-A station (240-V, 20-A two pole circuit breaker)	25	5.2	3.6	1.5
	50	10.4		3.0
	100	20.7		6.0
LEVEL 2 (240 volts and 12-80 amps) for 30-A station (240-V,40-A two pole circuit breaker):	25	5.2	7.2	0.75
	50	10.7		1.5
	100	20.7		3.0
DC fast charging (480 volts and up to 125 amps):	25	5.2	40	8
	50	10.4		16
	100	15.6		25

**Why Level 2 charging station is more suitable?**

The answer to this question lies in this fact that the most important condition for selecting an electric vehicle charging station location is that how much time is spend by the consumer for charging his vehicle in the charging station. So the time spend is an important factor.

From these charts, it is clear that for the same amount of distance travelled in km, electric vehicle required different charging time in each type of charging station .Also it is shown that Level 2 charging station provides facility to consumer to charge his vehicle in a very short time as compared to other types of charging station. The charts that are shown above prove this.

**Types of Electric Vehicles (EVs)**

EVs can be divided into the following categories. First, on-road highway speed vehicle that is an electrical vehicle capable of driving on all public roads and highways. The performance of these electrical vehicles is similar to Internal Combustion Engine vehicles. Second, the city electric vehicles, normally, the city electric vehicles have been BEVs (Battery Electric Vehicle - these vehicles can be powered 100% by the battery energy storage system available on-board the vehicle) that are capable of driving on most public roads, but basically not driven on highways. The maximum speed is typically limited to 55 mph. Third category of EVs is also known as low speed vehicles (LSVs). Actually they are BEVs that are limited to 25 mph and are allowed in certain jurisdictions to operate on public streets posted at 35 mph or less. Commercial On-Road Highway Speed

Vehicles is the last category of EVs. The commercial electric vehicles include commercial trucks and buses. These vehicles are available in both BEVs and PHEVs (Plug-in Hybrid Electric Vehicle – the vehicles utilizing a battery and an internal combustion engine (ICE) which is powered by either gasoline or diesel). Table 2 provides information on several different on-road highway speed electric vehicles, their battery pack size, and charge times at different power levels to replenish a depleted battery.

**Table 2:** Different types of EVs with battery pack size and charging times at different power levels (Adopted from [1])

EV Configuration	Battery Size (kWh)	110 VAC, 15 amp kW <sup>1</sup>	110 VAC, 20 amp 1.5 <sup>1</sup>	220 VAC, 40 amp 6 kW <sup>1</sup>	440 VAC, 85 amp 55 kW <sup>1</sup>
PHEV-10	4	230 minutes	160 m	40 m	n/a
PHEV-20	8	440 m	320m	80 m	n/a
PHEV-40	16	870 m	640m	160 m	17 m
BEV	24	1308 m	960 m	240 m	26m
BEV	35	1910 m	1400 m	350 m	38m
PHEV Bus	50	n/a	n/a	500 m	55m

**Note:** Power delivered to battery is calculated as follows: 110VAC x 12Amps x .85 eff.; 110VAC x 16Amps x .85 eff.; 220VAC x 32 Amps x .85 eff.; 480VAC x  $\sqrt{3}$  x 85 Amps x .85 eff. From Table 2, it is clear that different electric vehicle configuration require different charging time for different battery size at different power levels to replenish a depleted battery. This helps to find out the charging time in minutes required by different electric vehicle configurations of different battery size at different power levels. Using Table 3, we study the charging time for 100km of BEV range with power supply, power (in kW), voltage (in V) and maximum current (in A). It helps to show the relation of charging time of fixed 100km distance with its power supply, power (in kW), voltage (in V) and maximum current (in A). Thus, the driver finds charging an electric vehicle as simple as connecting a normal electrical appliance. In addition, Table 12 provides comparison between different recharge times of BEV for 100km range. Consequently, it seems clear that charging through single phase takes longer time then 10 minutes of direct current charging, that is the reason for advocating for DC charging infrastructure for EVs.

**Table 3:** Charging time for BEV range of Electric Vehicles (Adopted from [1])

Charging time for 100km of BEV range	Power supply	Power(in kW)	Voltage(in V)	Maximum current (in A)
6-8 hours	Single phase	3.3	230 V AC	16
3-4 hours	Single phase	7.4	230 V AC	32
2-3 hours	Three phase	10	400 V AC	16
1-2 hours	Three phase	22	400 V AC	32
20-30 minutes	Three phase	43	400 V AC	63
20-30 minutes	Direct current	50	400- 500 V DC	100-125
10 minutes	Direct current	120	300-500 V DC	300-350

#### ELECTRIC VEHICLE BATTERY

The electric vehicle battery is the core component of an electric vehicle with one of the two propulsion sources of HEV and PHEV. Basically, the battery is the sole propulsion source for BEV. There are still some constraints on present EV battery technology, which works as a barrier for wider EV uptake. The current EV battery has relatively low energy density. This low energy density directly affects the maximum all-electric drive range of

the EV. In addition, high battery cost of EV is also a big disadvantage as the purchase cost of EV is considerably higher than conventional internal combustion engine vehicle. Some concerns are also present about the battery life cycle and its safety features. However, EV battery goes through some tremendous improvements in the past decades. EV battery technology goes through a few development phases for inventing the battery with high-energy density, high power density, inexpensive, safe and durable. Lead-acid battery was the initial battery technology used in transportation and its name comes from the combination of lead electrodes and acid used to generate electricity. Lead-acid battery is a really a matured technology and also cheap. However, some apparent drawbacks of lead-acid battery are present, such as low energy density, heavy, require inspection of electrolyte level and are not environmentally friendly.

**Table 4:** Comparison of EV Battery Types and their specifications (Adopted from [3])

Battery type	Nominal voltage (V)	Energy density (Wh/kg)	Volumetric energy density (Wh/L)	Specific power (W/kg)
Lead acid(Pb-acid)	2	35	100	180
Nickel-cadium(Ni-Cd)	1.2	50-80	300	200
Nickel-metal hydride(Ni-MH)	1.2	70-95	180-220	200-300
ZEBRA	2.6	90-120	160	155
Lithium-ion (Li-ion)	3.6	118-250	200-400	200-430
Lithium-ion polymer (LiPo)	3.7	130-225	200-250	260-450
Lithium-iron phosphate (LiFePO4)	3.2	120	220	2000-4500
Zinc-air (Zn-air)	1.65	460	1400	80-140
Lithium-sulfur (Li-S)	2.5	350-650	350	-

**Table 5:** Comparison of EV Battery Types and their specifications (Adopted from [3])

Battery type	Life cycle	Self-discharge (% per month)	Memory effect	Operating temperature (1C)	Production cost (\$/kWh)
Lead acid(Pb-acid)	1000	<5	No	-15 to +15	60
Nickel-cadium (Ni-Cd)	2000	10	Yes	-20 to +50	250-300
Nickel-metal hydride(Ni-MH)	<3000	20	Rarely	-20 to +60	200-250
ZEBRA	>1200	<5	No	+245 to +350	230-345
Lithium-ion (Li-ion)	2000	<5	No	-20 to +60	150
Lithium-ion polymer (LiPo)	>1200	<5	No	-20 to +60	150
Lithium-iron phosphate (LiFePO4)	>2000	<5	No	-45 to +70	350
Zinc-air (Zn-air)	200	<5	No	-10 to +55	90-120
Lithium-sulfur (Li-S)	300	8-15	No	-60 to +60	100-150
Lithium-air (Li-air)	100	<5	No	-10 to +70	-

### Charging Vehicle Location Selection

The sites of the charging station have a very significant impact loads, at this point, charging station is very similar to traditional gas station, charging station requires a higher penetration of electric vehicles in areas surrounding the construction of a natural high, such as new urban planning to support key enter prices and so on. Our work contributes to identify suitable locations for construction of public charging stations. In this paper we have analyzed possibilities of establishing a public EV charging station in Agartala, India in particular. Charging stations located along the highways are also in high demand since high speed EVs usually requires fast charging.

## Public Charging Stations

In this section we will list and describe the most suitable charging locations for the installation of public charging stations. These charging stations can be located at parking lots that serve train stations, shopping centres, restaurants, hotels and resorts. When selecting a potential charging station, the following criteria should be considered.

### Traffic density

The first criterion is traffic density. Traffic density is a necessary factor because the size of the installation should be related to be expected number of users. If the charging station is located near a major road, with high traffic density, then maximum number of people may use it for charging their electrical vehicles. However, areas with high traffic density are in densely populated locations, where the land value is significantly higher. One way to address this concern is to use land that is already allocated for traditional parking lots and convert them to EVSPLs (Electric vehicles solar parking lots) [4]. Further, these lots can also be converted to multi-level parking's where the EV can be on the top where they receive sunlight whereas the traditional vehicles can be underneath.

### EV Charging Duration

The second criterion is EV charging duration; i.e. how long does it take to charge an electric vehicle. Electric vehicle need time to charge so it is necessary that the charging stations should be located near public places like shopping centres, work places, educational institutions so that people do not have to wait while their EVs are charging. The charging can happen while they are doing their usual activity such as being at work, weekly shopping etc. As (Nunes et al., 2016) suggests that public charging stations should be installed on worksites and public parks. This allows EV users to charge their EVs without having to wait [4].

### Surrounding Vehicle Movement

The third criterion is the surrounding vehicle movement. This is important because charging vehicles must not hinder normal traffic flow, as it will become a hurdle, which may even cause accidents. Further, this location must not hinder pedestrian traffic or be subject to high pedestrian traffic because of the associated risk of vandalism. Public EV charging stations have numerous effects on its surrounding environment, transportation and energy needs and hence these implications have to be examined carefully [4]. One way of implementation would be along the street side parking bays. Electric vehicles (EV) have a very diverse characteristic, as it can act both as consumer and producer. In first case, EV's act as consumer, it is depended on renewable energy resources, batteries, smart grid (G2V- Grid to vehicle) and electric chargers to recharge. In second case, it is producer as well, as EVs can be an essential part of the smart grid. It can act as an energy producer since it stores energy and can provide it back to smart grid when the demand is at peak, this process is known as discharge or (V2G- vehicle to grid). Whereas, there are some concerns about customers' behaviour in participating in V2G programs that is uncertainty about their participation. Describing the solar panels on parking panels and its impacts on energy in the surrounding areas, it is evident that parking lots are a lot more visible and hence can attract potential customers for electric vehicles making EV adoption much more easier [4]. Consequently, EV adoption can have significant positive impacts on human health [4]. Another impact of solar parking lots is their benefit to local market. Since customers will choose a shopping centre with solar parking lots because it will charge their cars while they do their shopping. This will boost the local economy [4]. In addition, there will be lots of employment opportunities for the local technicians to install and maintain a solar parking lot [4]. Hence, installing a solar parking lot is beneficial in a number ways for a particular location like Agartala, India and its surrounding areas.

### Winter Accessibility

The fourth criterion is winter accessibility. The location must be cleared and accessible during winter since some countries have severe winters [1]. The use of EVs should not depend on weather and hence EV public charging stations should be available at all times. Photovoltaic covered EV charging stations protect it from severe weather conditions like condensation, freezing rain and frost etc. [5].

### Protection from Collisions

The fifth criterion is protection from collisions. The location must provide protection against collisions. It is necessary to provide protection for avoiding accidents and public property damage. Also for maintaining peace in the environment of the road by avoiding fights which may occur due to the collisions of vehicles [1].

### Cellular network

The sixth criterion is cellular network access. Access to a cellular network is necessary if required by charging station [1]. Charging stations need to be in line of communication with smart grid since utilities like load management, peak demand and V2G programs depend on the communication that requires cellular network and Internet access as well. These two facilities can attract customers also since they cannot be out of coverage while present at a charging station. WIFI access can also help them connect to apps associated with their EVs and charging stations. In fact, public stations may provide telecommunications features, which will be different for different manufacturers. Many models contain transmitters compatible with cellular telephone networks and do not require additional infrastructure, while others will require a local wireless network, such as a ZigBee protocol network, which involves careful sitting of stations and transmitters. Also many stations communicate over a wired link, such as a twisted-pair or fiber-optic Ethernet network, which should be included in the design of the electrical installation.

### Visibility

The seventh criterion is visibility of charging station. Visibility of the charging station to encourage its use by drivers is an important factor [1]. It helps to increase number of users. If users can see the station from far places then it will help them to locate the charging station that increases the use of charging station.

### Feasibility of required excavation work and Proximity of distribution panel

The eighth criterion is feasibility of required excavation work and the ninth criteria are proximity of distribution panel [1]. Where a distribution panel is the component of an electric panel, its function is to divide the electricity feed to the “subsidiary” circuits [5]. Both of them are very important factor, which help to make the location more suitable for charging station. The proximity to the electrical service is an important factor in locating the public parking areas.

**Table 6:** Prime locations in Agartala and their mapping in different criteria

Location	Traffic Density	Surrounding vehicle movement	Winter accessibility	Protection from collisions	Cellular network	Visibility
Holy cross school	✓	✓	✓	✓		✓
Don Bosco School	✓	✓	✓	✓	✓	✓
the Agartala international school	✓	✓	✓	✓		✓
Henry Derozio School	✓	✓	✓	✓	✓	✓
Momos n More	✓	✓	✓	✓		✓
Raaste Cafe	✓	✓	✓	✓		✓
Hotel Sonari Tori	✓	✓	✓	✓	✓	✓
Hotel invitation, Royal Veg,	✓	✓	✓	✓		✓
Curry Club Restaurant	✓	✓	✓	✓		✓
Coffee Tea and Me	✓	✓	✓	✓		✓
Tripura Sundari College of nursing	✓	✓	✓	✓		✓
Women's College	✓	✓	✓	✓		✓
Maharaja Bikram College	✓	✓	✓	✓		✓
BBM College	✓	✓	✓	✓		✓
Tripura Government College.	✓	✓	✓	✓		✓
CBI Office	✓	✓	✓	✓	✓	✓
Agartala municipal council office	✓	✓	✓	✓		✓

Location	Traffic Density	Surrounding vehicle movement	Winter accessibility	Protection from collisions	Cellular network	Visibility
Directorate of higher education office	✓	✓	✓	✓		✓
Tripura Public Service commission office	✓	✓	✓	✓		✓
Krishi Bhawan office.	✓	✓	✓	✓		✓
Office of the AG	✓	✓	✓	✓		✓
Hotel Welcome Palace	✓	✓	✓	✓	✓	✓
Hotel City Center	✓	✓	✓	✓	✓	✓
Executive INN	✓	✓	✓	✓	✓	✓
Hotel Jaipur Palace	✓	✓	✓	✓	✓	✓
Rajdhani Hotel	✓	✓	✓	✓	✓	✓
Royal Guest House (Hotel)	✓	✓	✓	✓	✓	✓
Ginger Hotel.	✓	✓	✓	✓	✓	✓
ILS Hospital	✓	✓	✓	✓	✓	✓
GB Pant Hospital	✓	✓	✓	✓		✓
Devlok Hospital	✓	✓	✓	✓		✓
GB Hospital Medical College	✓	✓	✓	✓		✓
Tripura Medical College	✓	✓	✓	✓		✓
Agartala Government Medical College	✓	✓	✓	✓		✓
GB Hospital	✓	✓	✓	✓		✓
Green Touch Resort	✓	✓	✓	✓	✓	✓
Shyamali Tourist Resort	✓	✓	✓	✓	✓	✓
Hotel Woodland Park	✓	✓	✓	✓		✓
Rose Valley Amusement park.	✓	✓	✓	✓		✓
Laxminarayan Bari Mandir	✓	✓	✓	✓		✓
Jagannath Mandir	✓	✓	✓	✓		✓
Iskcon Bari, Durga Bari	✓	✓	✓	✓		✓
Ummaneshwar temple	✓	✓	✓	✓		✓
Fourteen Gods Temple	✓	✓	✓	✓		✓
Tripura Sundari temple	✓	✓	✓	✓		✓
M L Plaza, Metro Baazar	✓	✓	✓	✓	✓	✓
Bag Bazar	✓	✓	✓	✓	✓	✓
Agartala City Center,	✓	✓	✓	✓	✓	✓
Femme Zone/FEM Salon and spa	✓	✓	✓	✓		✓
Saradamani Shopping mall.	✓	✓	✓	✓	✓	✓
Agartala airport parking place	✓	✓	✓	✓	✓	✓
Railway station parking place	✓	✓	✓	✓		✓
Rupasi cinema hall	✓	✓	✓	✓		✓
Balaka cinema hall	✓	✓	✓	✓		✓
Tripura puppet theatre	✓	✓	✓	✓		✓

### Location Feasibility Analysis

For fast charging station infrastructure requires a concrete base and their installation is similar to that of street side locations. For this station, the conditions are:

The configuration of the station

The locations of any underground lines and tanks

The distance from the street(the charging cable must never extend over the sidewalk)

It required excavation work

The proximity of distribution panel

The planning of any underground conduits and excavation work.

It requires consultation with Info-Excavation before starting work.

The possibility of installing a concrete base

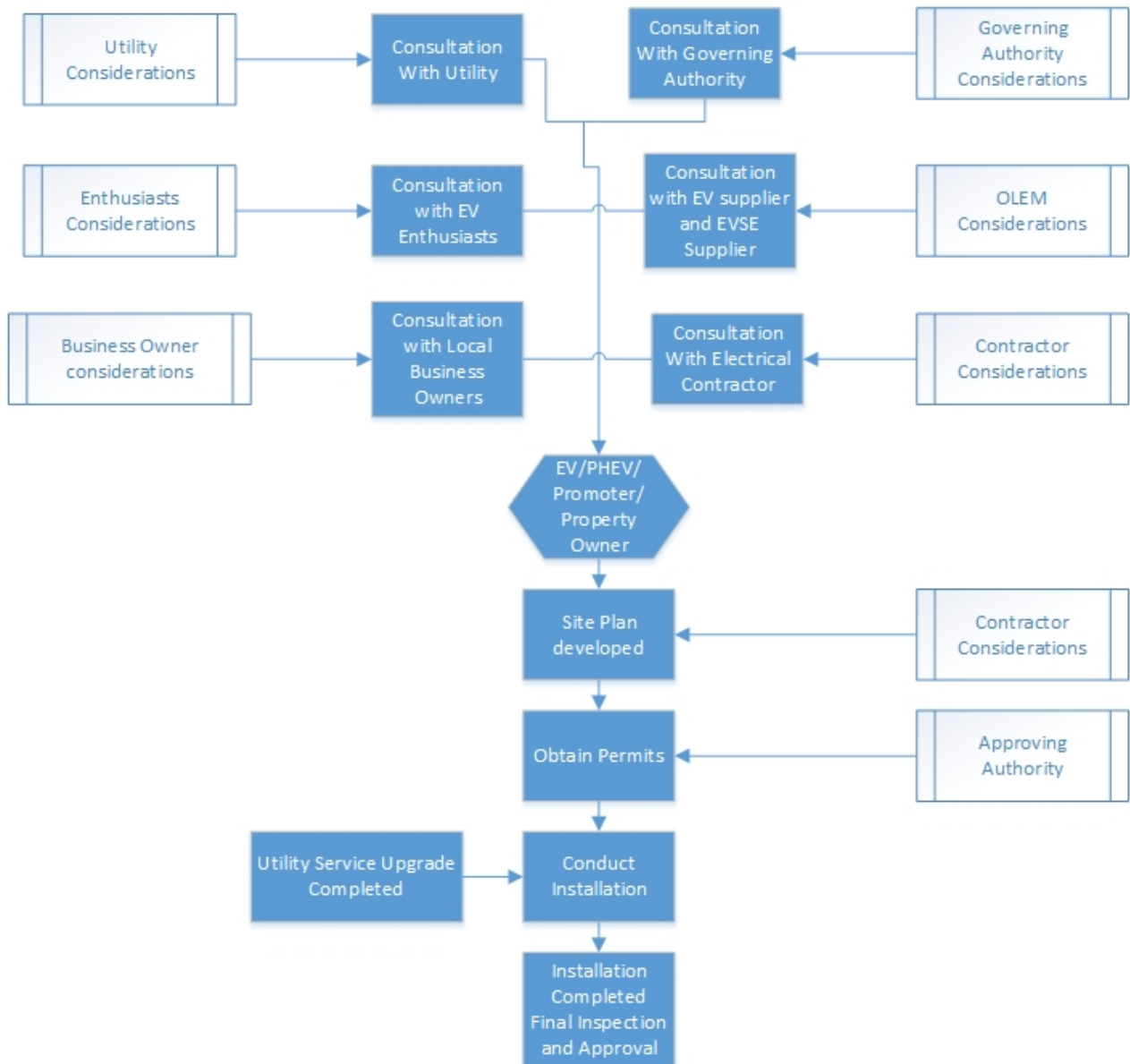
It requires contractor expertise (must have appropriate R B Q and C M E Q licenses).

For publicly available charging, the siting requirements are involve many questions such as ownership, vandalism, payment for use and maintenance. Also we must take care that flood prone area restrictions must be considered as well as issues of standing water or high precipitation. The people will not be comfortable when operating with the EVSE (Electric Vehicle Supply Equipment – these equipment helps in the transfer of energy between the electric utility power and the electric vehicle.) in standing water. The area designated for Public use should be in a preferred parking area.

### **Installation Flowchart for Public Charging**

The above flowchart summarizes the whole process of installing an EV public charging station. It starts with step one which is “consultation with utility” it includes utility consideration. The second step is “consultation with the governing authority”, it includes all the steps associated with public planning. Then, the constructors “consult with the EV enthusiasts”, these are the individuals or parties who want to promote and advertise EV and public charging stations. Subsequently, step four the builders consults the EV suppliers and EVSE suppliers that is determining the level of charging stations i.e level- 1, level-2 or fast DC charging stations. The step five of this charging station installation flow chart includes consultation with the local business owners for examples determining the quantity of solar energy for EVs. Step six, involves communication with electric contractors to assess the safety and accessibility measures for electric vehicle parking lots. Step seven, includes consultation with property owners and EV promoters. Step eight, involves the major step of developing the site plan development. It includes drawing the designs for electric vehicles parking lots. Step nine, includes obtaining required permits from government. Here all particular building rules should be satisfied. Step ten is the second last step of conducting installation. Step eleventh, in this step the construction of completed charging station is inspected and if every required is fulfilled then it is approved.





**Figure 4** Installation flow chart for installing Public EV charging Station (Adopted from [6])

**Proposed Locations for Charging Stations in Agartala**

Based on the criteria discussed above, we have identified some places for placing an electrical vehicle charging station that is further divided into some categories:

**Schools with parking place**

Schools with parking places especially solar parking lots where EVs can recharge is one of the best scenarios. An EVSPL (electric vehicle solar parking lot) is suitable for schools since parents of the students can recharge their EVs while they come to school for any engagement. In the same way since schools have large parking lots specially so it can be an alternative place for recharging EVs when other solar parking lots are fully packed. In addition, number of schools are greater than rare EVSPLs so school locations with EVSPLs can be an effective of reducing “range anxiety” and can result in successful EV adoption.

Keeping in view the earlier mentioned criteria for EVPLs we have identified some schools. These schools’ parking lots can be transformed in to EVSPLs. These schools are Holy cross school, Don Bosco School, the Agartala international school, Henry Derozio School.

**Restaurant with parking places**

Similarly the following places are suitable for EVSPLs. Momos n More, Raaste Cafe, Coffee Tea and Me, Hotel Sonari Tori, Hotel invitation, Royal Veg, Curry Club Restaurant.

*College with parking place:* Colleges that are suitable for constructing EVSPL are : Tripura Sundari College of nursing, Women's College, Maharaja Bikram College, BBM College, Tripura Government College.

*Government offices with parking places:* Government offices with EV charging stations can be an effective solution as well for strengthening EV market. CBI Office , Office of the AG, Agartala municipal council office, Directorate of higher education office, Tripura Public Service commission office, Krishi Bhawan office.

**Hotel with parking places**

These hotels with EV charging stations is ideal since they are public and potential customers spend more hours there. Hotel Welcome Palace, Hotel City Center, Executive INN, Hotel Jaipur Palace, Rajdhani Hotel, Royal Guest House (Hotel), Ginger Hotel.

**Hospital with parking place**

Hospitals with EV charging stations can be count on in times of emergency as well. ILS Hospital, GB Hospital, GB Pant Hospital, Devlok Hospital, Apollo Gleneagles Hospital Information Center, GB Hospital Medical College, Tripura Medical College, Agartala Government Medical College.

*Resort with parking place:* Resorts are also a better place to install public charging stations. Since, not only visitors visit this place but hotel staff and general public can also come to resorts for festive seasons. Hence, it becomes a densely populated area with requirement for a electric vehicle public charging stations. Some are of the suitable places for this purpose in Agartala India are Green Touch Resort, Shyamali Tourist Resort, Hotel Woodland Park, Rose Valley Amusement Park.

**Temple with parking place**

Temples are best locations for installing public electric vehicles charging stations since this is one of the public places with good space. Some of the appropriate places for setting up EV charging stations in temples of Agartala are: Laxminarayan Bari Mandir , Jagannath Mandir, Iskcon Bari, Durga Bari , Ummaneshwar temple, Fourteen Gods Temple, Tripura Sundari temple.

**Shopping center with parking place**

In addition, shopping centers are one of the most suitable place for public charging stations due to its parking requirements and the frequency of potential EV customers' visit. Some public charging stations can be installed in these shopping centres in Agartala i.e ML Plaza, Metro Baazar, Bag Bazar, Agartala City Center, Femme Zone/FEM Salon and spa, Saradamani Shopping mall.

**Agartala airport parking place**

Agartala airport parking place is another example of suitable place of installation of EV parking place due to the availability of parking space and public reach. Agartala airport can provide convenience for airport visitors, cab owners and staff of the airport. A public charging station installed at airport can also attract new EV customers due to its convenience.

**Other public places for EV public charging stations installation**

Subsequently, railway stations, petrol stations and cinema halls with parking spaces are ideal for constructing public EV charging stations. Due to high traffic density, visibility, availability of cellular network and the entire criterion based on above table we can suggest that the EV public charging stations should not only be installed here but it will also strengthen EV customer base in Agartala, India. Some places identified in this regard are Rupasi cinema hall, Balaka cinema hall and Tripura puppet theatre.

**4. Future Work**

It is better to visit each parking place then make a record of the number of users using these place, infrastructure is needed to make favorable electrical vehicle charging station or making a website showing locations of private and public charging stations in Agartala. It will increase more users and a website can be developed displaying the cost ratings and quality of charging stations in Agartala. We further check which type of charging stations are more suitable for the location based on the number of users utilising it.

**References**

- [1] “ELECTRIC VEHICLE CHARGING STATIONS. Technical Installation Guide.” [Online]. Available: <http://docplayer.net/9608482-Electric-vehicle-charging-stations-technical-installation-guide.html>. [Accessed: 01-Feb-2017].
- [2] J. Y. Yong, V. K. Ramachandaramurthy, K. M. Tan, and N. Mithulanathan, “A review on the state-of-the-art technologies of electric vehicle, its impacts and prospects,” *Renew. Sustain. Energy Rev.*, vol. 49, pp. 365–385, Sep. 2015.
- [3] P. Nunes, R. Figueiredo, and M. C. Brito, “The use of parking lots to solar-charge electric vehicles,” *Renew. Sustain. Energy Rev.*, vol. 66, pp. 679–693, Dec. 2016.
- [4] T. Lepley and P. Nath, “Photovoltaic covered-parking systems using lightweight, thin-film PV,” in *Conference Record of the Twenty Sixth IEEE Photovoltaic Specialists Conference - 1997*, 1997, pp. 1305-1308.
- [5] “Distribution board,” Wikipedia. 03-Mar-2017.
- [6] “Electric Vehicle Charging Infrastructure Deployment Guidelines,” *Electric Transportation Engineering Corporation*, Jul. 2009.

# Effect of Weather Change on Hydrogen Production via Electrolysis Powered by Photovoltaic System

Rungchai Kaensakol<sup>1</sup>, Nawadee Srisiriwat<sup>2,\*</sup> and Anuchart Srisiriwat<sup>3</sup>

<sup>1</sup>Department of Electrical Engineering, Faculty of Engineering

<sup>2</sup>Department of Petrochemicals and Environmental Management, Faculty of Engineering

<sup>3</sup>Department of Advanced Manufacturing Technology, Faculty of Engineering  
Pathumwan Institute of Technology, 833 Rama I Rd., Pathumwan, Bangkok 10330, Thailand

## Abstract

Hydrogen can be used as a non-toxic energy storage and transport medium. Hydrogen that is made from water using solar energy from photovoltaic panel is a sustainable and renewable energy supply for home and vehicle. Hydrogen can be produced via electrolysis when the sun shines and then use the stored hydrogen to produce heat and electricity on demand for day or night. However, Thailand weather consists of six months of rainfalls during the rainy season. Consequently, this study investigates the effect of changing weather on the solar irradiance on a rainy day resulting in the electrolysis efficiency and performance of hydrogen production. The effects of solar irradiance on power demand for water electrolysis to produce hydrogen and on hydrogen production are also determined. The result of hydrogen production on rainy day is presented to estimate the feasibility of hydrogen production by water electrolysis powered by photovoltaic system integrated fuel cell system for generate electricity for use all day in the rainy season.

**Keywords:** Electrolysis, Hydrogen production, Photovoltaic

## 1. Introduction

In 2014 the UN's Intergovernmental Panel on Climate Change (IPCC) reported the IPCC's Fifth Assessment Report [1], which speaks about a very high confidence (>90%) that Global warming effect has been caused by an increase of atmospheric concentrations of greenhouse gases, such as carbon dioxide, methane, and nitrous oxide. Much policy analysis has focused on carbon dioxide from burning fossil fuels (coal, oil, and natural gas), which comprise about 60% of total global greenhouse gas emissions in 2010; the industrial and power sectors have much larger impacts on climate than agriculture. The increasing consciousness of the possible anthropogenic effect on climate change in combination with the instabilities in the fossil fuel market are leading to an increasing political force to decrease greenhouse gas emissions and to stimulate renewable energy.

As the development of renewable energy in Thailand increased gradually and the perspective of Ministry of Energy of Thailand in energy security, economy and ecology to increase domestic renewable energy production has been focused, the Alternative Energy Development Plan (AEDP2015) was developed to set a target of renewable energy sources to replace 30 percent of final energy consumption (in form of electricity, heat and Bio-fuel) by the year 2036 [2].

One of the most interesting developments of photovoltaic (PV) power systems is their integration with other energy sources. Electrolysis is one of the hydrogen production processes for the fuel cell/PV hybrid system. Certainly, the hydrogen production via water electrolysis process from electricity supplied by PV power system allows non-polluting. Hydrogen can be produced by a water electrolysis process powered by the solar energy and thereafter it can be used to produce electricity through fuel cell (FC) which is useful for the remote area. Moreover, unlike a secondary battery, the fuel cell does not only store energy but also produce electricity for unlimited time to support the PV power generator [3]. In our previous work [4], we have applied the solar power system via PV to generate hydrogen for energy storage purposes of the hybrid power system and performed an energy analysis of water electrolyzer for photovoltaic and proton exchange membrane fuel Cell (PEMFC) hybrid power system.

So far, many researches on water electrolysis related to hydrogen production are concentrated on alkaline electrolysis systems and PEM electrolysis. PEM electrolysis has various advantages over conventional alkaline electrolysis systems due to their ecological cleanliness, simplicity, high efficiency and easy production capacity [5-7]. There are many studies on the hydrogen production via water electrolysis integrated PV cell. Dahbi et al. [8] performed a complete modelling of the PV-electrolysis system using Matlab/Simulink environment to control a water flow in the electrolysis, leads to an improvement on maximization of the power

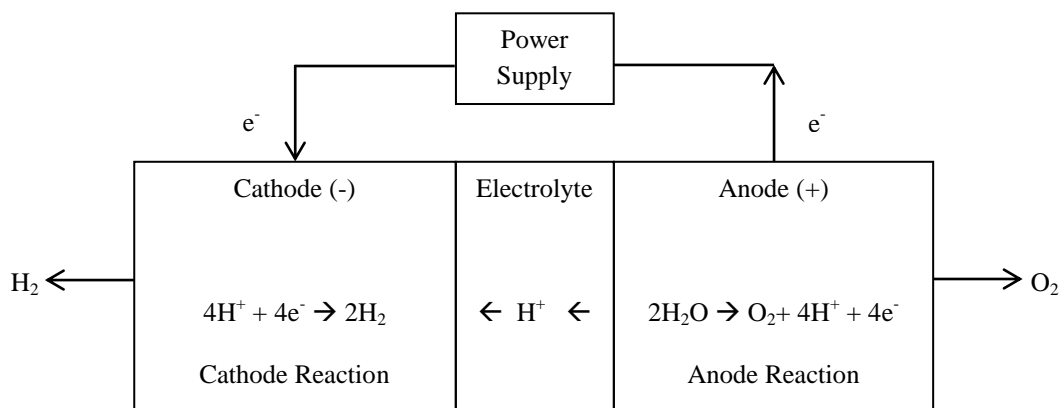
\*Corresponding author; e-mail: navadee@hotmail.com

drawn from the PV module obtaining the maximum amount of hydrogen produced in the electrolysis. Bilgen [9] developed a mathematical model for optimizing the thermal and economical performance of large scale photovoltaic-electrolyzer systems, either with fixed or sun tracking panels. Jensen et al. [10] solved a problem of the large fluctuations in delivery due to changing weather of wind and solar power for Solid Oxide Electrolyzer Cell. Abdel-Aal [11] estimated the economic feasibility of a solar-energy stand-alone system including PV modules, water electrolyzer and FC. Mohammed et al. [12] performed the best design of a PV/FC hybrid power system focused on the economic performance. Lopes and Watanabe [13] investigated the effects of current, voltage, electrical power on the performance of electrolyzer for hydrogen production. Lajnef et al. [3] proposed the integration between the fuel cell power system and the PV generator in order to overcome the problem of PV power fluctuations. However, most research has not taken into account the effect of a changing weather on the solar irradiance resulting in the performance of hydrogen production via water electrolysis and thereafter on the PV-electrolysis system.

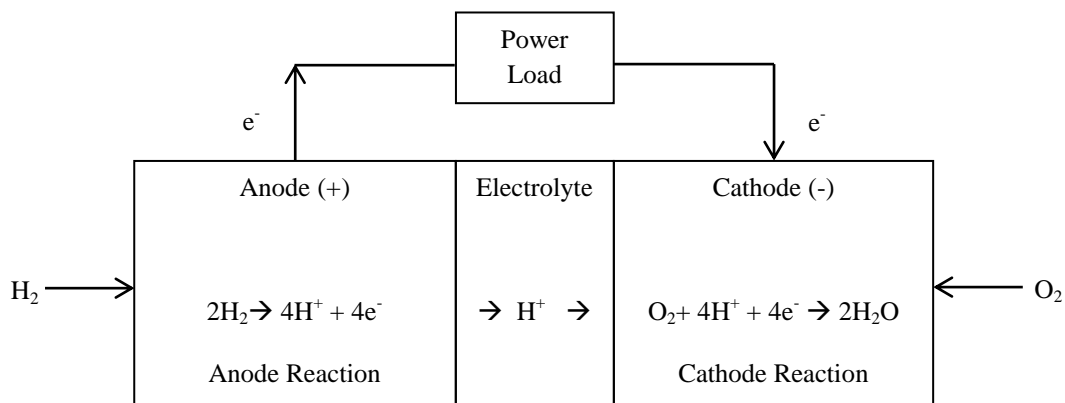
As mentioned above, the objectives of research are to investigate the effect of weather change on hydrogen production via electrolysis powered by photovoltaic system and to analyze the system performance for hydrogen production on the rainy and cloudy day.

## 2. Materials and methods

The electrolysis process is considered as a well-known principle to produce hydrogen and oxygen gases. The proton exchange membrane water electrolysis is based on the use of a polymeric proton exchange membrane as the solid electrolyte that was firstly proposed for fuel cell, and later, electrolyzer applications. Electrolyzer is a device which applies an electric current to provide the energy that splits a water molecule ( $H_2O$ ) into hydrogen ( $H_2$ ) and oxygen ( $O_2$ ). Hydrogen gas is generated on the negative side (cathode) while oxygen gas is generated on the positive side (anode). A proton exchange membrane (PEM) electrolyzer is one of electrolyzers when it is connected to an electric current as shown in figure 1, but can also work in reverse and provide power as a hydrogen fuel cell as illustrated in figure 2.



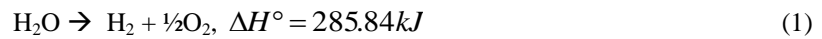
**Figure 1** Principle of PEM water electrolysis.



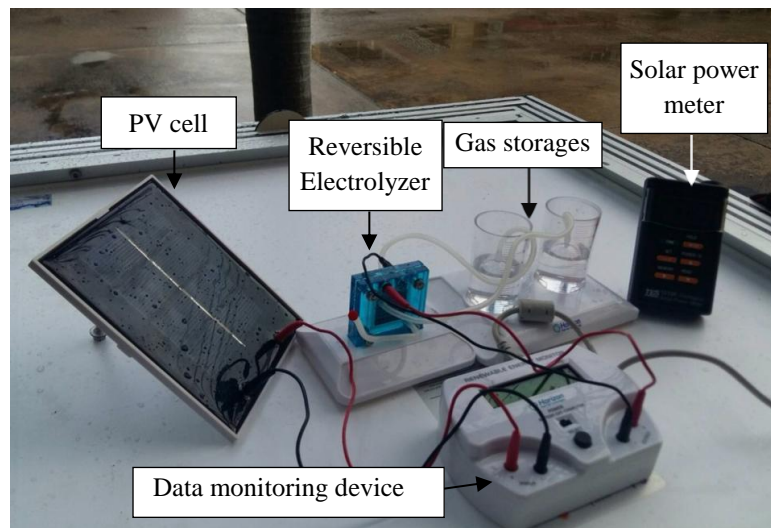
**Figure 2** Principle of PEM fuel cell (adapted from [3]).

In figure 1, the electrical current is supplied across the electrochemical cell to induce electrochemical reactions at both electrodes. Water is introduced at the anode side and dissociated into oxygen, protons, and electrons. The protons are driven by an electric field through the PEM to the cathode side where combined with the external circuit transferring the electrons to form hydrogen gas.

The electrolyzer studied in this work is a one-cell reversible PEM electrolyzer (can be used as both electrolyzer and FC) made by the company, Horizon Fuel Cell Technologies as shown in figure 3. The electrode dimensions of electrolyzer are 2.5 cm x 2.5 cm. It consists of the membrane electrolyte enclosed by two electrodes (anode and cathode) and tubes for filling water and passing produced hydrogen and oxygen gases to the gas storage. The electrolyzer is powered by a 1 W of PV cell. A data logging solar power meter (TES-1333R) connected RS-232 was used to measure solar irradiance in different weather conditions. In this experiment, the data of voltage, current and power supplied to electrolyzer were measured and monitored by using the Renewable Energy Monitor from the Horizon Fuel Cell Technologies. The electrolyzer is a device that decomposes a water molecule by means of an electrical current to produce a mole of hydrogen and a half mole of oxygen as written in Equation (1).



where  $\Delta H^\circ$  is the enthalpy of the reaction at 1 atm and 25°C.



**Figure 3** Experimental setup of water electrolyzer integrated photovoltaic panel operated on a rainy day.

As mentioned before, for each moles of hydrogen that are produced, two electrons circulate through the external circuit. Consequently, the charge of one mole of electrons that pass round the external circuit is given by Equation (2).

$$\text{Total charge} = -2Fn_{\text{H}_2} \quad (2)$$

Where  $n_{\text{H}_2}$  is the total amount of moles of hydrogen that are produced and  $F$  is the Faraday's constant (96,484 C/mol).

As the absolute value of Equation (2) is presented, it can be rearranged as written in Equation (3).

$$\text{H}_2 \text{ flow} = \frac{I}{2F} \left[ \frac{\text{mole}}{\text{s}} \right] \quad (3)$$

Where  $I$  is the DC current used to produce hydrogen in the electrolyzer.

Therefore, the volumetric hydrogen flow (ml/min) can be derived as Equation (4) [13].

$$\text{H}_2 \text{ flow} = 7.477 \times I \left[ \frac{\text{ml}}{\text{min}} \right] \quad (4)$$

### 3. Results and discussion

Effects of weather conditions on the solar irradiance and on the performance of hydrogen production from water electrolyzer powered by solar energy at different time for 7 days were investigated as shown in figures 4 and 5, respectively. The data of solar irradiance at different time, 7.30 – 7.40 a.m., 12.30 – 12.40 p.m., and 16.30 – 16.40 p.m. were collected in the morning, afternoon, and evening to study the effect of changing weather. In figure 4, for rainy season, at 7.30 – 7.40 a.m. the 2<sup>nd</sup>, 4<sup>th</sup>, 5<sup>th</sup> day and at 12.30 – 12.40 p.m. the 2<sup>nd</sup>, 3<sup>rd</sup>, and 7<sup>th</sup> day and at 16.30 – 16.40 p.m. the 1<sup>st</sup> and 6<sup>th</sup> day showed the low values of solar irradiance because of the cloudy and on the 4<sup>th</sup> day at 16.30 – 16.40 p.m., it was raining. Figure 5 also shows the effect of weather change on the hydrogen production at which the lower solar irradiance on the rainy and cloudy day, the lower hydrogen production. On the sunny day, especially, the 4<sup>th</sup> day at 12.30 – 12.40 p.m. gave the highest solar irradiance of 942.30 W/m<sup>2</sup> and the highest hydrogen production of 110.40 ml/hr.

The relationship between the solar irradiance and the solar power supplied to electrolysis (see figure 6) was estimated by using linear function with R-square value of 0.811 as given by Equation (5).

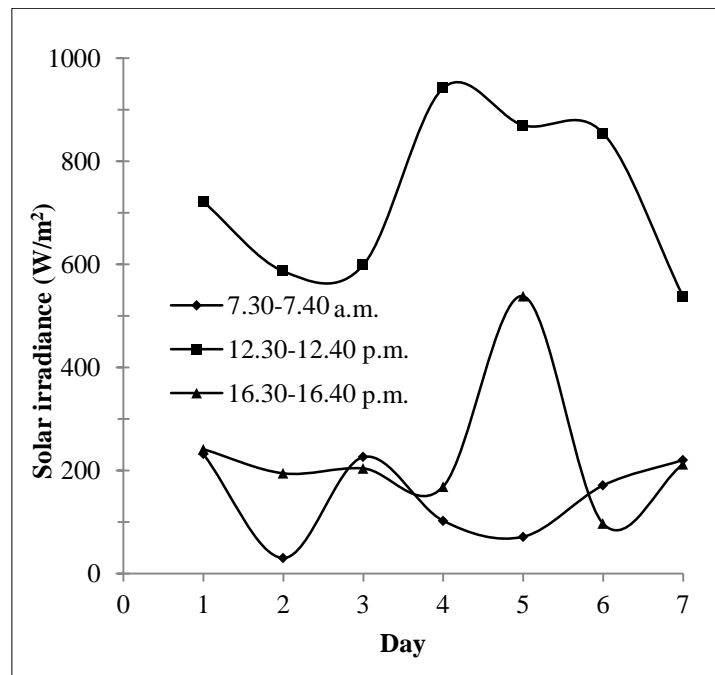
$$y = 0.0008 x \quad (5)$$

Where  $x$  is solar irradiance (W/m<sup>2</sup>) and  $y$  is electrolysis power demand (W). It is noted that this experiment tested for the 1 W of PV cell integrated with PEM electrolyzer for 6.25 cm<sup>2</sup> area.

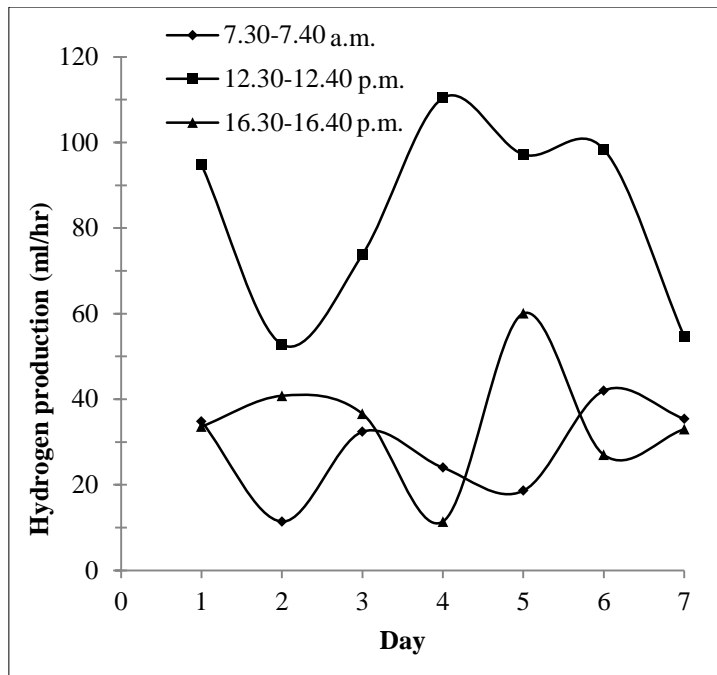
The relationship between the solar irradiance and the hydrogen production (see figure 7) was estimated by using linear function with R-square value of 0.8681 as given by Equation (6).

$$y = 0.1191 x \quad (6)$$

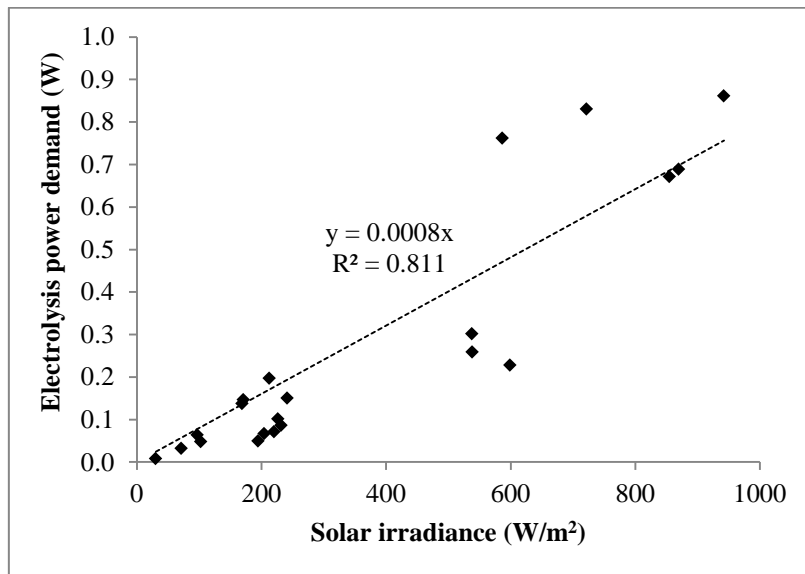
Where  $x$  is solar irradiance (W/m<sup>2</sup>) and  $y$  is hydrogen production flow rate (ml/hr). Again, it is noted that this experiment tested by using the 1 W of PV cell integrated with PEM electrolyzer for 6.25 cm<sup>2</sup> area.



**Figure 4** Solar irradiance at different time for 7 days operating.

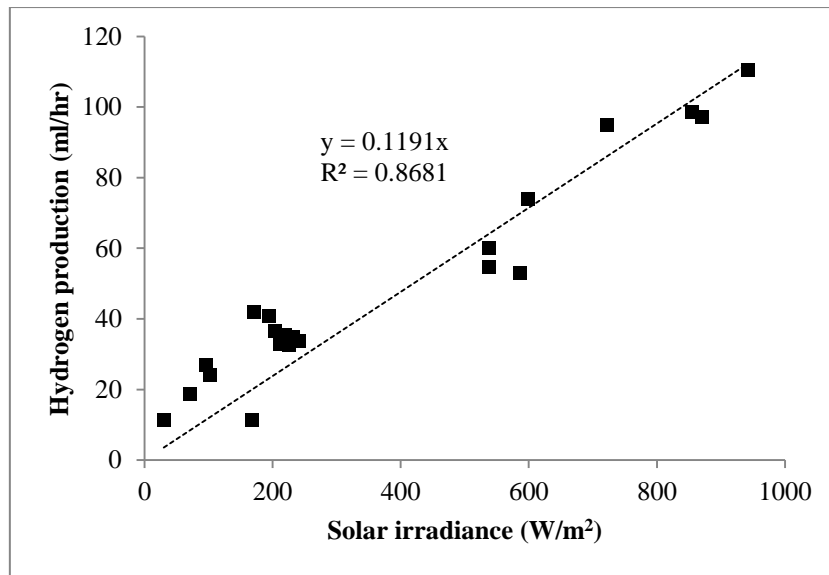


**Figure 5** Hydrogen production from water electrolyzer integrated photovoltaic panel at different time.



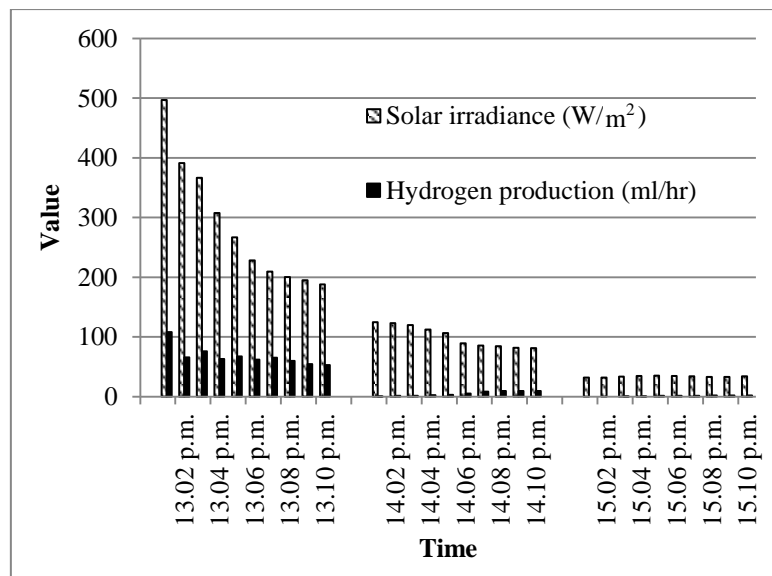
**Figure 6** Effect of solar irradiance on power demand for water electrolysis to produce hydrogen.





**Figure 7** Effect of solar irradiance on amount of hydrogen production via electrolysis process.

In this research, the effect of weather change on the hydrogen production was investigated to report the feasibility of the use of PV/FC hybrid system in Thailand. This paper is a preliminary experiment for one day of weather change to determine the amount of hydrogen production on the rainy and cloudy day. Figure 8 demonstrates the solar irradiance and amount of hydrogen production on the rainy and cloudy day to investigate the performance of hydrogen production on the rainy day. The time of cloudy was approximately started to test from 13.01 – 13.10 p.m. and the time of raining was started to test from 14.01 – 14.10 p.m. At 15.01 – 15.10 p.m., it was heavy rainfall that the results presented very tiny amount of solar irradiance and hydrogen production. The average values of solar irradiance and hydrogen production from 15.01 – 15.10 p.m. were 33.72 W/m<sup>2</sup> and 1.02 ml/hr, respectively. As a result, if the hybrid PV/FC power system integrated water electrolysis was applied to use as a stand-alone power system for the remote area, the alternative energy resources other than PV solar panels or reserved batteries may be considered when the sunlight is not sufficient.



**Figure 8** Solar irradiance and hydrogen production on the rainy and cloudy day (September 30<sup>th</sup>, 2017).

Figure 9 shows the experimental and theoretical hydrogen production flow rate calculated by using Equation (4) for DC current range between 0.126 and 0.282 A from the data in range of 13.01 – 13.10 p.m. in figure 8. The experimental hydrogen production gave lower values than the theoretical hydrogen flow. However, the results for 0.126 to 0.282 A DC current range showed that experimental and theoretical hydrogen flow agree quite well for this range.

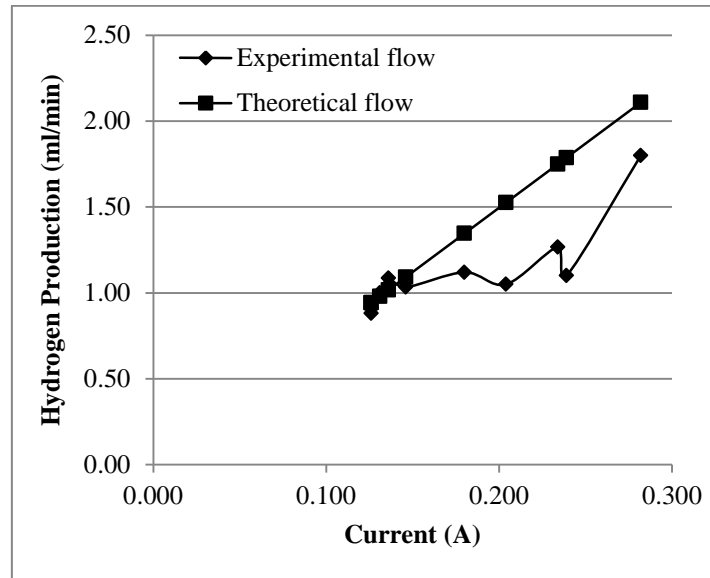


Figure 9 Experimental and theoretical hydrogen flow.

#### 4. Conclusions

A number of advantages of the water electrolysis process such as the high energy conversion efficiency, the zero greenhouse gas emission, and the use of water as hydrogen resource, make it a good option for use in the energy storage system integrating renewable energy. The water electrolysis process can be powered by photovoltaic to produce hydrogen in day time. In night time, electricity is produced by FCs when hydrogen is utilized as fuel and FCs also produce fresh water as a by-product. In this study, special attention has been paid to investigate the effect of the change of weather condition, especially in the rainy season, on the hydrogen production from water electrolysis integrated photovoltaic system. An increase of solar irradiance increases the yield of hydrogen production. In addition, the results showed that on the rainy and cloudy day gave the lower solar irradiance that affects the low performance of hydrogen production. Consequently, the alternative energy resources other than PV system or reserved batteries may be considered when the sunlight is not enough. In the future work, results of the water electrolyzer for photovoltaic/fuel cell hybrid system in all seasons will be presented to optimize the hybrid power system.

#### Acknowledgements

Authors gratefully acknowledge the Pathumwan Institute of Technology Research Fund for financial support.

#### References

- [1] IPCC's Fifth Assessment Report, Intergovernmental Panel on Climate Change (IPCC), Climate Change 2014: Mitigation of Climate Change Available from: <https://www.ipcc.ch/report/ar5/wg3/>.
- [2] Information on <http://www.eppo.go.th/images/POLICY/ENG/AEDP2015ENG.pdf>.
- [3] Lajnef T, Abid S, Ammous A. Modeling, Control, and Simulation of a Solar Hydrogen/Fuel Cell Hybrid Energy System for Grid-Connected Applications. **Advances in Power Electronics**. 2013; 1-9.
- [4] Kaensakol R, Srisiriwat A. Energy Analysis of Water Electrolyzer for Photovoltaic/Fuel Cell Hybrid Power System. **Proc. 4th International Conference on Applied Electrical and Mechanical Engineering 2017 (ICAEME 2017)**, Nongkhai, Thailand, August 31 - September 2, 2017; 15-18.
- [5] Meng Ni, Leung MKH, Leung DYC. Energy and exergy analysis of hydrogen production by a proton exchange membrane (PEM) electrolyzer plant. **Energ Convers Manage**. 2008; **49**: 2748-2756.

- [6] Selamat OF, Becerikli F, Mat MD, Kaplan Y. Development and testing of a highly efficient proton exchange membrane (PEM) electrolyzer stack. **Int J Hydrogen Energy**. 2011; **36**: 11480-11487.
- [7] Carmo M, Fritz DL, Mergel J, Stolten D. A comprehensive review on PEM water electrolysis. **Int J Hydrogen Energy**. 2013; **38**: 4901-4934.
- [8] Dahbi S, et al., Optimised hydrogen production by a photovoltaic - Electrolysis system DC/DC converter and water-flow controller, **Proc. 3rd International Renewable and Sustainable Energy Conference (IRSEC)**, 2015, Available from: <http://ieeexplore.ieee.org/stamp/stamp.jsp?arnumber=7455129>.
- [9] Bilgen E. Solar hydrogen from photovoltaic-electrolyzer systems. **Energ Convers Manage**. 2011; **42**: 1047-1057.
- [10] Jensen SH, et al., Hydrogen and synthetic fuel production from renewable energy sources. **Int J Hydrogen Energy**. 2007; **32**: 3253-3257.
- [11] Abdel-Aal H, et al. Feasibility Study for a Solar-Energy Stand-Alone System: (S.E.S.A.S.). **Smart Grid and Renewable Energy**. 2012; **3**: 204-206.
- [12] Mohammed OH, et al. Optimal Design of a PV/Fuel Cell Hybrid Power System for the City of Brest in France. **Proc. 2014 First International Conference on Green Energy**. 2014; 119-123.
- [13] Lopes FC, Watanabe EH. Experiment and Theoretical Development of A PEM Electrolyzer Model Applied to Energy Storage Systems. **Proc. 2009 Brazilian Power Electronics Conference**. 2009; 775-782.

# Power Loss Comparison of Pulse Width Modulation Techniques Based on Space Vector Method by MATLAB/SIMULINK

Kanitphan Boonsomchuae<sup>1</sup>, and Satean Tunyasirut<sup>1,\*</sup>

<sup>1</sup>Faculty of Engineering, Pathumwan Institute of Technology, 833 Rama 1 Rd., Wangmai, Pathumwan, Bangkok, 10330, Thailand

## Abstract

This paper investigates the power loss characteristic of pulse width modulation (PWM) techniques based on space vector method for two-level three-phase voltage source inverters. In this study, we consider the conventional space vector pulse width modulation (CSVPWM) technique, 30° discontinuous space vector pulse width modulation (DSVPWM) technique, 60° DSVPWM technique, 120° DSVPWM technique and unipolar pulse width modulation (UPWM) based on space vector technique, because they are different in the switching sequence (switching pattern) affecting to switching losses. For analysis and comparison, the power loss characteristic has been investigated with the modeling and simulation technique. The inverter, pulse width modulation (PWM) control unit, and insulated-gate bipolar transistor (IGBT) module are modeled by using the MATLAB/SIMULINK program. The simulation results show that the UPWM technique provides the highest efficiency if the load phase angle is in the range from 0° to 35° and from 60° to 85°, and the 60° DSVPWM technique provides the highest efficiency if the load phase angle is in the range from 35° to 60°. However, the CSVPWM technique is the lowest efficiency technique. Finally, a new hybrid PWM technique decreasing the power losses in the inverter has been presented in this paper.

**Keywords:** space vector pulse width modulation, unipolar pulse width modulation, power losses, discontinuous space vector pulse width modulation

## 1. Introduction

Nowadays the pulse width modulation (PWM) technique of the two-level three-phase voltage source inverter with the conventional space vector pulse width modulation (CSVPWM) technique has been widely used for many applications [1]. The CSVPWM technique has been developed as the 30° discontinuous space vector pulse width modulation (DSVPWM) technique, 60° DSVPWM technique, 120° DSVPWM technique and unipolar pulse width modulation (UPWM) technique respectively [2 - 5]. The UPWM technique is based on the unipolar method, but the others are the bipolar method. In addition, the DSVPWM techniques including the UPWM technique can decrease the power losses in insulated-gate bipolar transistor (IGBT) modules (switching devices) due to the hold of gating signals [2, 5]. Each PWM technique provides the individually the switching sequence (switching pattern) and uses differently the dwell time of two zero vectors. Therefore, each technique has the specifically switching sequence for gating signals. Moreover, the switching losses in the inverter are not only depended on the switching frequency, but also depended on the switching sequence. Some switching sequences change the switching state in the vicinity of the peak output current, and some switching sequences hold the switching state in the vicinity of the peak output current. Thus, the power losses of the inverter relates to the switching frequency, the switching sequence, and the phase angle of inverter loads. To choose the right technique for a given application in term of low power losses, the PWM techniques based on space vector method are studied and compared.

Modelling and simulation techniques have presented to understand the power losses in the inverter model instead of testing in real devices. The literatures [6 - 9] have proposed inverter models and power loss calculation models. In this study, we consider the power loss characteristic. Hence, the simplex models using only the information in IGBT datasheets are enough to estimate the power losses in IGBT modules.

## 2. Objectives

The objectives of this study are to comparatively evaluate the power loss characteristics of various PWM techniques based on the space vector method and to present the fast and low-cost implementation way of the investigation the power losses by means of the MATLAB/SIMULINK program.

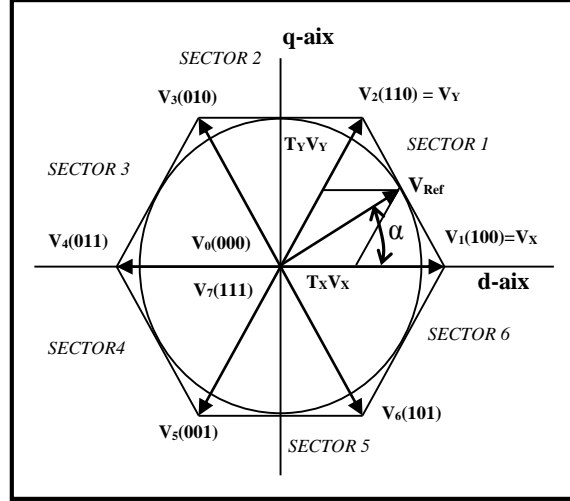
---

\*Corresponding author; e-mail: satean@pit.ac.th

### 3. Definition of the Considered PWM Techniques

#### 3.1 CSVPWM Technique

Two-level three-phase voltage source inverters have six switching devices and can generate eight voltage vectors in the complex d-q plane. The eight vectors are composed of six active vectors,  $V_1$  to  $V_6$ , and two zero vectors ( $V_Z$ ),  $V_0$  and  $V_7$ , as shown in Figure 1.



**Figure 1** Switching states of CSVPWM technique

In the CSVPWM technique [1-3], the state of only one leg of the inverter is changed; while, the voltage vector is changing from one vector to another vector. Thus, the reference voltage vector,  $V_{ref}$ , is the sum of two adjacent active vectors,  $V_X$  (the vector precedes the reference vector) and  $V_Y$  (the vector follows the reference vector), and two zero vectors,  $V_0$  and  $V_7$ . The dwell time of each vector is the duty cycle time of the switching devices corresponding with the vector. On volt-second balancing principle, the dwell time of the voltage vectors in a sampling period can be formulated as [4]

$$V_{ref} T_s = T_X \cdot V_X + T_Y \cdot V_Y + T_Z \cdot V_0 / 2 + T_Z \cdot V_7 / 2 \quad (1)$$

where

- $T_s$  sampling time;
- $T_X$  dwell time of  $V_X$ ;
- $T_Y$  dwell time of  $V_Y$ ;
- $T_Z$  dwell time of the zero vector.

The  $T_X$ ,  $T_Y$ , and  $T_Z$  are formulated as (2), (3), and (4) respectively [2, 4].

$$T_X = T_s \cdot M \cdot \sin(60^\circ - \alpha) / \sin(60^\circ) \quad (2)$$

$$T_Y = T_s \cdot M \cdot \sin(\alpha) / \sin(60^\circ) \quad (3)$$

$$T_Z = T_s - T_X - T_Y \quad (4)$$

$M$  is defined as the modulation index, and  $\alpha$  is defined as the reference-vector angle in a sector. The switching state sequences of this technique are explained in Table 1.

#### 3.2 DSVPM Techniques

A new PWM technique based on space vector method can be designed by changing of the dwell time of two zero vectors [2, 3]. In CSVPWM technique, the  $T_Z$  is equally divided for two zero vectors to decrease the ripple current. In the DSVPM techniques [1-4], the  $T_Z$  is utilized for only one zero vector,  $V_0$  or  $V_7$ , in a sampling period to decrease the switching losses in switching devices. However, the utilization of active vectors of DSVPM technique is similar to the CSVPWM technique. The DSVPM techniques are based on bipolar

method and can be classified into three groups as [2]: 30° DSVPWM technique, 60° DSVPWM technique, and 120° DSVPWM technique.

#### 1) 30° DSVPWM technique

In 30° DSVPWM technique [3], the switching sequence can be generated by changing the kind of zero vector ( $V_0$  and  $V_7$ ) in the middle of all sectors. In odd sectors, the zero vector  $V_0$  is used in the first-half of the odd sectors, and the zero vector  $V_7$  is used in the second-half of the odd sectors. In even sectors, the zero vector  $V_7$  is used in the first-half of the even sectors, and the zero vector  $V_0$  is used in the second-half of the even sectors. In this technique, every switching device is held continually for 30° duration in every quarter of the fundamental output voltage. The switching state sequence of this technique is explained in Table 1.

#### 2) 60° DSVPWM technique

In 60° DSVPWM technique [2, 3], the switching sequence can be generated by alternating the utilization of zero vector ( $V_0$  and  $V_7$ ) in every sector. The zero vector  $V_7$  is used in odd sectors and the zero vector  $V_0$  is used in even sectors. In this technique, every switching device is held continually for 60° duration in every half of the fundamental output voltage. The switching state sequence of this technique is explained in Table 1.

#### 3) 120° DSVPWM technique

In 120° DSVPWM technique [2, 3], the switching sequence can be generated by using the zero vector  $V_7$  in every sector. In this technique, every switching device is held continually for 120° duration in the fundamental output voltage. The switching state sequence of this technique is explained in Table 1.

**Table 1** Switching sequences of the bipolar method in six sectors

Sector	CSVPWM	30°DSVPWM	60°DSVPWM	120°DSVPWM
1	( $V_0V_1V_2V_7V_2V_1V_0$ )	( $V_2V_1V_0V_1V_2$ ), ( $V_1V_2V_7V_2V_1$ )	( $V_1V_2V_7V_2V_1$ )	( $V_1V_2V_7V_2V_1$ )
2	( $V_0V_3V_2V_7V_2V_3V_0$ )	( $V_3V_2V_7V_2V_3$ ), ( $V_2V_3V_0V_3V_2$ )	( $V_2V_3V_0V_3V_2$ )	( $V_3V_2V_7V_2V_3$ )
3	( $V_0V_3V_4V_7V_4V_3V_0$ )	( $V_4V_3V_0V_3V_4$ ), ( $V_3V_4V_7V_4V_3$ )	( $V_3V_4V_7V_4V_3$ )	( $V_3V_4V_7V_4V_3$ )
4	( $V_0V_5V_4V_7V_4V_5V_0$ )	( $V_5V_4V_7V_4V_5$ ), ( $V_4V_5V_0V_5V_4$ )	( $V_4V_5V_0V_5V_4$ )	( $V_5V_4V_7V_4V_5$ )
5	( $V_0V_5V_6V_7V_6V_5V_0$ )	( $V_6V_5V_0V_5V_6$ ), ( $V_5V_6V_7V_6V_5$ )	( $V_5V_6V_7V_6V_5$ )	( $V_5V_6V_7V_6V_5$ )
6	( $V_0V_1V_6V_7V_6V_1V_0$ )	( $V_6V_1V_7V_1V_6$ ), ( $V_1V_6V_0V_6V_1$ )	( $V_6V_1V_0V_1V_6$ )	( $V_1V_6V_7V_6V_1$ )

### 3.4 UPWM Technique

Reference [5] proposing the UPWM technique has presented a new switching state called 'x'. The state x means that the both upper and lower switching devices in a leg are OFF. In the state x, the output voltage of the leg is depended on the current direction. If the current flows from the leg to the load, the output voltage is  $-V_{dc}/2$  and the switching state is called 'x+'. In contrast, if the current flows from the leg to the DC source, the output voltage is  $+V_{dc}/2$  and the switching state is called 'x'. If the current is crossing the zero value, the output voltage is uncertain and the switching state is called 'x0'. The output voltage waveform of the UPWM technique will be similar to the output voltage waveform of the bipolar method if it is under the conditions [5]:

- 1) The load of inverter must be the low-power AC motor, and
- 2) The inverter leg must be held to the DC bus when the output current is crossing the zero.

In UPWM technique, the zero vector  $V_0$  is used in odd sectors and the zero vector  $V_7$  is used in even sectors. The switching states of this technique can be shown in Figure 2, and the switching sequence of this technique has been defined as  $|V_Y-V_X-V_Z|$ . Moreover, equations (2), (3), and (4) can be used to calculate the  $T_X$ ,  $T_Y$ , and  $T_Z$  respectively.

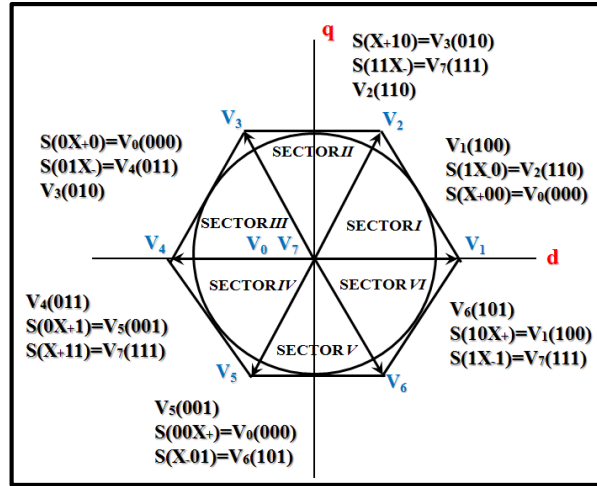


Figure 2 Switching states of UPWM technique

#### 4. Power Loss Estimator and Inverter Model

##### 4.1 Power Loss Estimation Model

Many literatures have proposed methodologies to calculate or estimate the power losses in the inverter made up with the IGBT modules [6, 7, 8]. In this study, we consider the efficiency of each PWM control technique; thus, the power loss estimation algorithm should be fast and not too complex. Reference [8] has proposed the power loss estimation model by using only the information in IGBT datasheets; moreover, the model can show the power losses for the entire operation condition of the inverter.

The power losses of the IGBT module consist of conduction losses (static losses) and switching losses (transient losses) [6, 7, 8]. The conduction losses comprise IGBT conduction losses ( $P_{IGBTcond}$ ) and diode conduction losses ( $P_{Dcond}$ ). The conduction losses can be obtained by multiplying the instantaneous current by the on-state voltage drop. The on-state voltage drop across IGBT, collector-emitter saturation voltage ( $V_{CE}$ ), can be expressed as  $V_{CE} = V_T + r_T \cdot i$ . The IGBT threshold voltage,  $V_T$ , and IGBT conduction slope,  $r_T$ , can be estimated by using the output characteristic ( $V_{CE}$  vs.  $I_C$ ) curves. The forward voltage drop across diode, forward voltage ( $V_F$ ), can be expressed as  $V_F = V_D + r_D \cdot i$ . The diode threshold voltage,  $V_D$ , and diode conduction slope,  $r_D$ , can be estimated by using the diode forward characteristic curves. The switching losses comprise IGBT switching losses ( $P_{IGBTsw}$ ) and diode switching losses ( $P_{Dsw}$ ). The switching losses are calculated by dividing the switching energy losses by the time period. The switching energy losses can be found by using the turn-on/off energy curves in the IGBT datasheet. A curve-fitting method, second-order polynomial approximation, is applied to approximate the energy losses in the turn-on/off energy curves. The IGBT switching energy losses can be found by using the turn-on energy ( $E_{on}$ ) and turn-off energy ( $E_{off}$ ) curves. The diode switching energy losses can be found by using the diode recovery energy ( $E_{rr}$ ) curves. The power loss estimation algorithm of two IGBT modules in the phase-A leg (leg A) can be expressed as [8]:

$$P_{IGBTcond} = \frac{1}{T} \int_0^T |i_a| (V_T + r_T |i_a|) dt_{(S_a=1) \& \& (i_a > 0) || (S_a=0) \& \& (i_a < 0)} \quad (5)$$

$$P_{Dcond} = \frac{1}{T} \int_0^T |i_a| (V_D + r_D |i_a|) dt_{(S_a=1) \& \& (i_a < 0) || (S_a=0) \& \& (i_a > 0)} \quad (6)$$

$$P_{IGBTsw} = \frac{1}{n} \sum_{j=1}^n E_{on(i_a > 0) \& \& (turn_{on}) || (i_a < 0) \& \& (turn_{off})} + \quad (7)$$

$$+ \frac{1}{n} \sum_{j=1}^n E_{off(i_a < 0) \& \& (turn_{on}) || (i_a > 0) \& \& (turn_{off})}$$

$$P_{Dsw} = \frac{1}{n} \sum_{j=1}^n E_{rr(i_a > 0) \& \& (turn_{on}) || (i_a < 0) \& \& (turn_{off})} \quad (8)$$

where

- $i_a$  instantaneous current of phase A;
- $S_a$  gate signal state of upper switch;
- $turn_{on}$  turn-on state of IGBT;
- $turn_{off}$  turn-off state of IGBT.

The MATLAB/SIMULINK models of the estimation algorithms, (5) to (8), are shown in Figure 3. The total power losses of the inverter are equal to three times the sum of (5) to (8) because of three-phase balancing. In this study, the parameters of (5) to (8) are obtained from the SEMIX151GD066HD's datasheet.

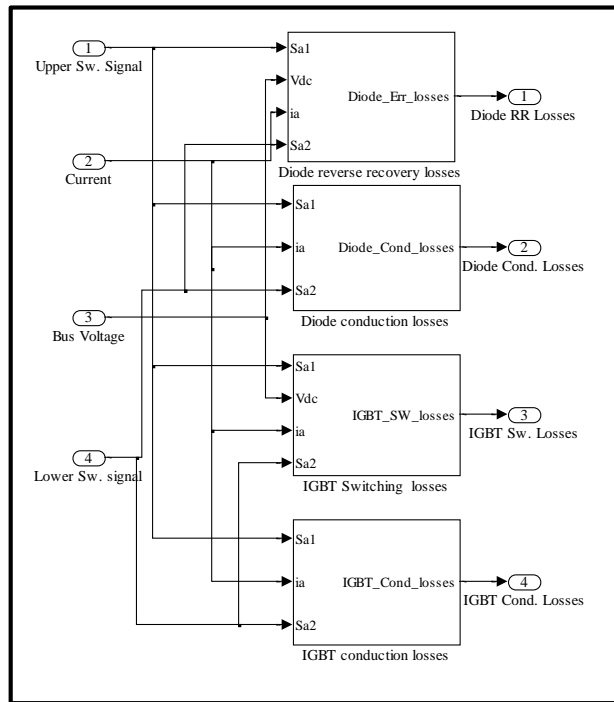


Figure.3. MATLAB/SIMULINK mode of power loss estimation model

#### 4.2 Inverter Model

The inverter and PWM controller models proposed by [9] have been accepted and widely used to simulate the inverter operation.

In [9], the PWM controller model was based on CSVPWM technique. In this study, the PWM controller model was adapted to simulate the various PWM techniques, as shown in Figure 4. Each algorithm of PWM techniques was changed according to the switching state sequences as explained in Table 1 and Figure 2.

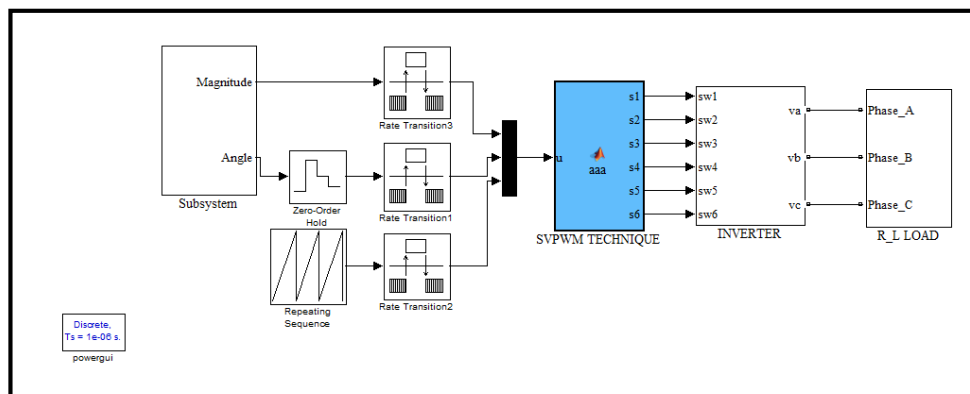


Figure 4 MATLAB/SIMULINK model of two-level three-phase voltage source inverter



## 5. Simulation results

The inverter and power loss estimation models operated under the conditions:

- 1) Voltage bus ( $V_{dc}$ ) = 450 V,
- 2) Sampling time = 0.0002 s,
- 3) Output frequency = 50 Hz,
- 4) Modulation index ( $M$ ) = 0.9, and
- 5) Magnitude of R-L Load ( $|Z|$ ) = 1.1548 ohm.

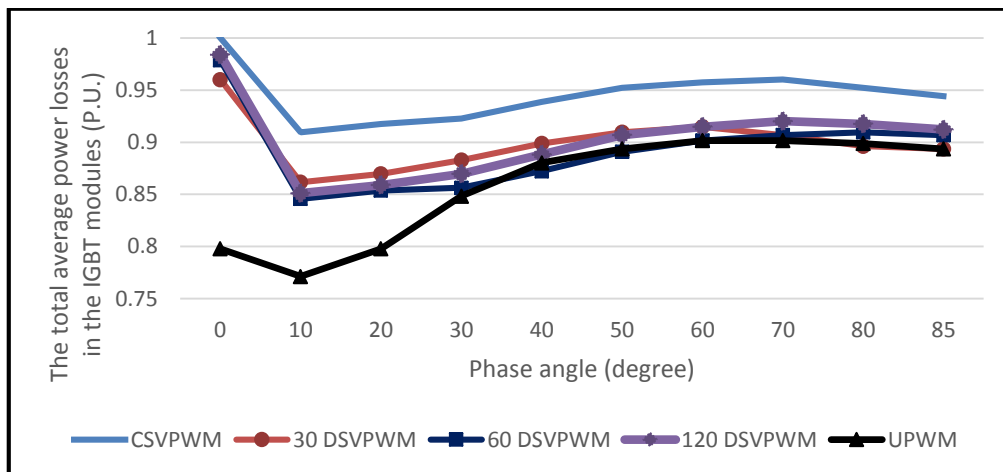
Figure 5 shows the simulation results explaining the power losses of various PWM techniques versus the phase angle (lagging). The total average power losses of all PWM techniques were divided by the maximum power-loss value of the CSVPWM technique and shown in per unit (P.U.). In Figure 5, the results showed that the CSVPWM technique was the highest power loss technique. Conversely, the UPWM technique was the lowest power loss technique if the load phase angle ( $\phi$ ) was in the range from  $0^\circ$  to  $35^\circ$  and from  $60^\circ$  to  $85^\circ$ . In addition, the  $60^\circ$  DSVPWM technique was the lowest power loss technique if the load phase angle was in the range from  $35^\circ$  to  $60^\circ$ .

Figure 6 shows the simulation waveforms: the phase current ( $i_a$ ), the upper switching signal of leg A, and the lower switching signal of leg A. Moreover, Figure 6 (a)-(e) present the simulation results of the CSVPWM technique,  $30^\circ$  DSVPWM technique,  $60^\circ$  DSVPWM technique,  $120^\circ$  DSVPWM technique and UPWM technique respectively. As shown in Figure 6 (a)-(d), the upper and lower switching signals were complementary logic, because they were based on the bipolar method. Therefore, the inverter must protect short-circuit events in the leg by using dead-time circuits. However, the upper and lower switching signal of the UPWM technique, as shown in Figure 6 (e), indicated that they were not complementary logic, thus the dead-time circuits in the inverter can be neglected.

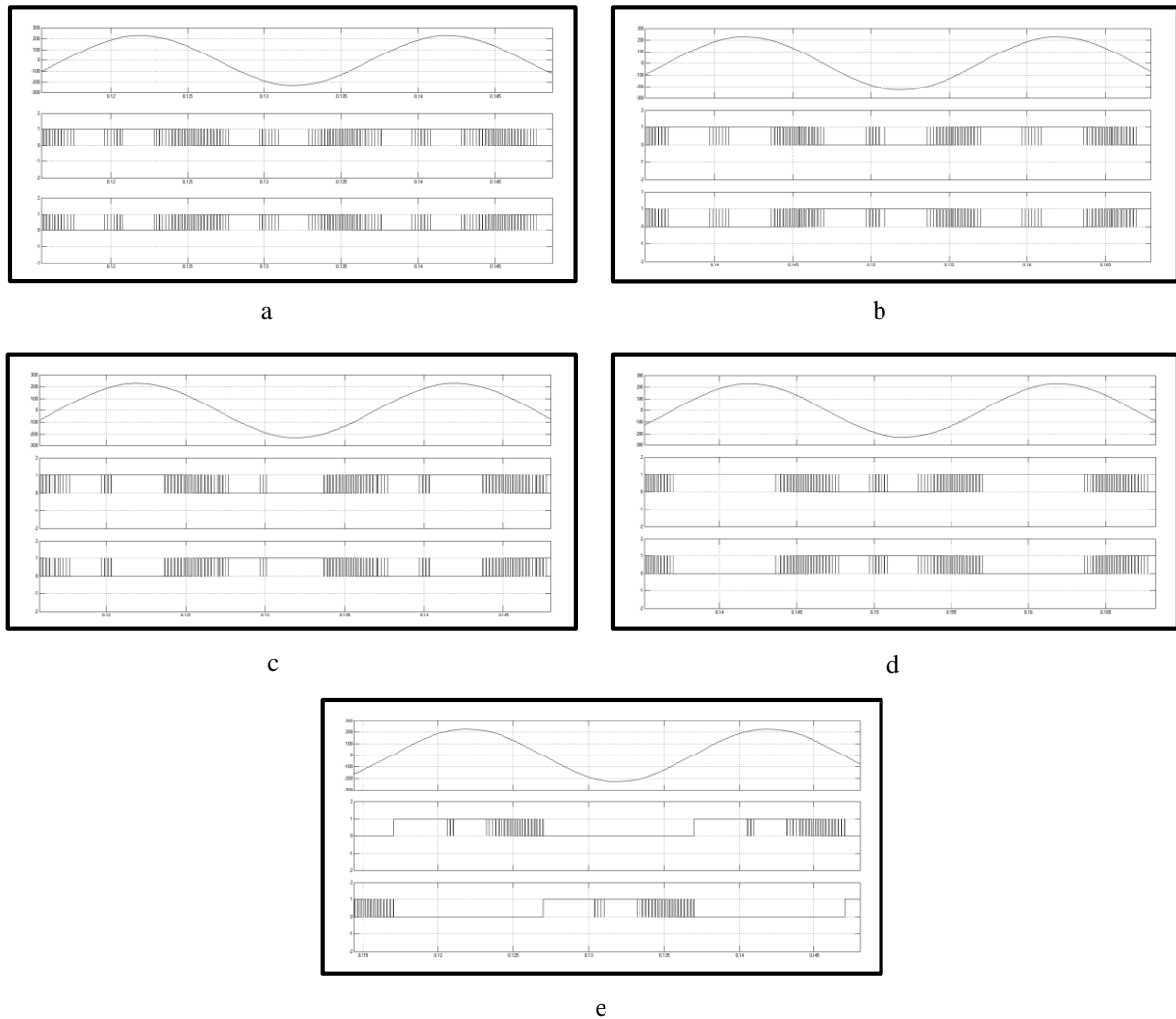
In Figure 6 (a), the both switching devices in the leg were switched in the vicinity of the peak output current; consequently, the power losses of CSVPWM technique is the highest losses.

The both switching signals, as shown in Figure 6 (b)-(c), were held continually for  $30^\circ$ ,  $60^\circ$ , and  $120^\circ$  duration respectively. Therefore, the losses of all DSVPWM techniques were lower than the losses of CSVPWM technique.

In Figure 6 (e), only one switching device in the leg was switched, whereas the other one was turned off. Moreover, the switching signals were held continually for  $60^\circ$  duration in the vicinity of the peak output current. Therefore, the UPWM technique was the lowest losses technique.



**Figure 5** Total average power losses of various PWM techniques versus load phase angle



**Figure 6** Simulation waveforms at  $M=0.9$  and  $\varphi = 30^\circ$ : (a) CSVPWM technique, (b)  $30^\circ$ DSVPWM technique, (c)  $60^\circ$ DSVPWM technique, (d)  $120^\circ$ DSVPWM technique, and (e) UPWM technique

#### 4. Conclusions

This paper has comparatively evaluated the power losses of the CSVPWM technique,  $30^\circ$ DSVPWM technique,  $60^\circ$ DSVPWM technique,  $120^\circ$ DSVPWM technique, and the UPWM technique by using the MATLAB/SIMULINK program. The inverter and power loss estimation model were designed and simulated to predict the total average power losses in the inverter model. The simulation results indicate that the efficiency of the PWM technique based on unipolar method is better than the PWM technique based on bipolar method because of the switching state 'x'. Furthermore, the results as shown in Figure 5 can be used to devise a new hybrid PWM technique which combines the UPWM technique and the  $60^\circ$  DSVPWM technique to decrease the power losses in the inverter. The UPWM technique is utilized if the load phase angle is in the range from  $0^\circ$  to  $35^\circ$  and  $60^\circ$  to  $85^\circ$ . If the load phase angle is in the range from  $35^\circ$  to  $60^\circ$ , the  $60^\circ$ DSVPWM technique is utilized.

Further study will include the comparison of the simulation results and actual experiment results. In actual experiment [10], the input power was directly measured by using an analog multiplier to multiply the DC bus voltage by the DC bus current, and the output power was measured by two-wattmeter method using two analog multiplier to multiply the output line-line voltage by the output phase current. Finally, the total power losses of the inverter can be found by subtracting the output power from input power.

## References

- [1] Van der Broeck HW, Skudelny HC, Stanke G. Analysis and Realization of a pulse width modulator based on voltage space vector. **IEEE Transactions on Industry Application**. 1988; **24**(1): 142-150.
- [2] Trzynadlowski AM, Legowski S. Minimum-Loss Vector PWM Strategy for Three-Phase Inverters. **IEEE Transactions on Power Electronics**. 1994; **9**(1):26-34.
- [3] Blasko V. Analysis of a Hybrid PWM Based on Modified Space-Vector and Triangle-Comparison Methods. **IEEE Transactions on Industry Application**. 1997; **33**(3):756-764.
- [4] Narayanan G, Krishnamurthy HK, Zhao D, Ayyanar R. Advanced bus-clamping PWM techniques based on space vector approach. **IEEE Transactions on Power Electronics**. 2006; **21**(4):974-984.
- [5] Chen K, Ji S, Zhang L. Two-Level Three-Phase Voltage Source Inverter Fed Low-Power AC Induction Motor Based on Unipolar Pulse-Width Modulation Method. **IET Power Electronics**. 2016; **9**(3): 435-440.
- [6] Luo Z. **A Thermal Model for IGBT Modules and its Implementation in a Real Time Simulator [dissertation]**. University of Pittsburgh; 2002.
- [7] Rui W, Jialiang W, Jian H, Zhongyuan C, Quanqing W, Na J, Chenghao W. A Power Loss Calculation Method of IGBT Three-Phase SPWM Converter. **Proceedings of 2nd International Conference on Intelligent Systems Design and Engineering Applications (ISDEA2012)**. China: 2012; **4**:1180-1183.
- [8] Pou J, Osorno D, Zatozoza J, Ceballos S, Jaen C. Power Losses Calculation Methodology to Evaluate Inverter Efficiency in Electrical Vehicles. **Proc. of the 7th Int. Conf. on Compatibility and Power Electronics CPE**. Tallinn, Estonia; 2011:404-409.
- [9] Iqbal A, Larnine A, Ashra I, Mohibullah. Matlab/Simulink Model of Space Vector PWM for Three-Phase Voltage Source Inverter. **Universities Power Engineering Conference, 2006. UPEC /06. Proceedings of the 41st International**. 2006; **3**: 096-1100.
- [10] Trzynadlowski AM, Kirlin RL, Legowski S. Space vector PWM technique with minimum switching losses and variable pulse rate. **IEEE Transactions on Industrial Electronics**. 1997; **44** (2):173-181.

# **Session of Computer and Information Technology**

# Ontology-based Multi-agent Systems: An Overview of Existing Approaches

Pornpit Wongthongtham<sup>1,\*</sup> Udsanee Pakdeetrakulwong<sup>2,\*</sup> Suksawat Sae-Lim<sup>2</sup> and  
Atisak Chatcharoenporn<sup>3</sup>

<sup>1</sup>School of Information Systems, Curtin University, Western Australia, Australia

<sup>2</sup>Nakhon Pathom Rajabhat University, Nakhon Pathom, Thailand

<sup>3</sup>Advanced Info Service Public Company Limited, Thailand

## Abstract

Software agent and multi-agent systems have attracted considerable attention and become active research areas in recent years. Furthermore, the advent of the Semantic Web technology has provided the underlying infrastructure that allows software agents to process data and performs sophisticated tasks on behalf of users. Consequently, the agent-based technology has become much more practical and the number of emerging real-world applications has increased, spanning a wide range of domains. In this paper, a survey of ontology-based multi-agent systems has been conducted and focused in particular on what they can assist users in software engineering domain. From the result of the survey, some open research issues that are used to outline the motivation for the future work are presented.

**Keywords:** Agent-based technology, Ontology-based multi-agent systems, Software agent

## 1. Introduction

The agent-based technology has become much more practical and has attracted considerable attention in recent years. Although an agent can work as a stand-alone entity to perform a particular task on behalf of a user, many of the agent-based applications are operated in environments that contain multiple agents collaboratively working together as a group, otherwise known as a multi-agent system. Multi-agent systems offer various advantages compared with a single agent, such as reliability and robustness, modularity, scalability, adaptability, concurrency, parallelism, and dynamism. They are employed in several real-world applications, spanning a wide range of domains such as e-learning, healthcare, web-services, supply chain management, etc.

This study is aimed at providing the understanding of ontology-based multi-agent systems and what they are used for in each domain. The main purpose is to identify the benefits and usefulness as well as the gaps or issues of the existing systems. The period of study is within the last ten years when those works have been presented in scientific conferences or journals. This paper is structured in the following manner. In Section 2, the background of software agent, multi-agent systems, and the integration of ontology and multi-agent systems are introduced. In Section 3, a survey of ontology-based multi-agent systems are presented. In Section 4, discussion of the surveyed systems and open research issues are described. In Section 5, conclusion and future work are presented.

## 2. Agent-Based Technology

### 2.1 Software Agent

The agent-based technology has attracted considerable attention and become active research areas in recent years. In addition, the advent of the Semantic Web technology has provided the underlying infrastructure that allows software agents to process data and perform sophisticated tasks on behalf of users. Regarding the term “agent”, the following definition is widely accepted:

“An agent is a computer system that is situated in some environment and that is capable of autonomous action in this environment in order to meet its delegated objectives.” [1]

Accordingly, the key properties of an agent are as follows [2, 3]

---

\* Corresponding author; e-mail: <sup>1\*</sup>[ponnie.clark@curtin.edu.au](mailto:ponnie.clark@curtin.edu.au), <sup>2\*</sup>[udsanee@webmail.npru.ac.th](mailto:udsanee@webmail.npru.ac.th)

- **Autonomy:** agents encapsulate some state and make decisions on what to do based on this state without the direct intervention of humans or others.
- **Reactivity:** agents are situated in an environment and are able to perceive this environment through their sensors. Then, through effectors, they respond in a timely fashion to changes that occur in their environment.
- **Pro-activeness:** agents do not simply act in response to their environment. They are able to exhibit goal-directed behaviour by taking the initiative.
- **Social ability:** agents are able to cooperate with humans and other agents in order to achieve their design objectives.

Software agents can be differentiated from traditional software applications in terms of certain characteristics. The differences between traditional software applications and software agents are presented in Table 1 which is adapted from [4].

**Table 1** Differences between traditional software applications and software agents adapted from [4]

Characteristics	Traditional software applications	Software agents
Nature	Static	Dynamic
Autonomy	Follow instructions	Be able to perform tasks without direct control, or at least with the minimum of human intervention
Manipulation	User initiates every action	Sense the environment and react autonomously
Interactivity	Non-interactivity	Can interact with other agents, humans, or software programs
Temporal continuity	Terminate when process is complete	Continue to run over time (persistent)
Concurrency	Generate process in one dedicated server with limited processing power	Dispatch simultaneously to accomplish several parts of a task in parallel
Mobility	Stay in one place	Be able to travel from one machine to another

From Table 1, it is clear that the software agents are different from traditional software applications. Moreover, compared with the object-oriented paradigm, the agent technology can be considered as a descendant that improves the nature of passive objects with the notion of autonomous actors [5]. In contrast to simple objects with methods that can be invoked by other objects, an agent communicates with other agents by means of message-passing. In addition, it can act proactively to accomplish its individual goal. Agents can work as stand-alone entities to perform particular tasks on behalf of a user. However, many agent applications are based on environments that contain multiple agents collaboratively working together as a group. This is also known as a multi-agent system.

## 2.2 Multi-Agent System

Even though an individual agent can perform a task on behalf of a single user, its capacity is limited by its knowledge and resources. Thus, agents are usually implemented in a multi-agent context. A multi-agent system (MAS) consists of multiple agents acting in an environment to achieve a common goal or their individual goals [6]. There is an increasing interest in MAS research because of its significant advantages including its ability to solve problems that may be too large for a single agent. MAS allows a complex task to be decomposed into sub-tasks, each of which is then assigned to an individual agent to undertake independently, but which can be supported by a knowledge base. They have distributed architectures which control distribution by utilising the mechanisms of cooperation and coordination.

MAS have various advantages over a single agent, such as reliability and robustness, modularity, scalability, adaptability, concurrency, parallelism, and dynamism [7]. When a system is implemented based on MAS architecture, it is easy to add a new functionality or to modify an existing functionality. Within MAS, the functionality is created by calling the service that a particular agent offers. Therefore, in order to add a new functionality, a new agent responsible for a new service can be added into a system. In order to modify or improve the functionality of the system, the existing agent can be modified or substituted with a new one. In this case, a system is loosely coupled which means that it is easy to extend, remove, and modify without breaking down the system. In addition, MAS can make the system more fault-tolerant by replacing an agent that has crashed with a new agent that can be launched on the fly as a substitute for a failing agent [8].

MAS are suitable for applications that require distributed and concurrent processing capabilities. They are employed in the applications in several domains such as supply chain management [9-11], web-services [12, 13], healthcare [14-16], e-learning [8], etc. When a group of individual agents constitutes MAS, it is crucial to have a mechanism that can control such a group. Communication is a key for MAS to exhibit social behaviour (e.g., share information, coordinate their tasks). Individual agents in MAS interact with one another by exchanging messages using a specific Agent Communication Language (ACL). The purpose of ACL is to enable agents to convey messages to one another with meaningful statements [17]. Most ACLs are based on the speech-act theory. Speech acts are expressed by means of standard key words also known as communicative acts or performatives (e.g., request, inform, confirm, and propose). They are used to inform the intention of the communication from the sender to the receiver. The agent's message consists of various parameters such as sender, receiver, content language, ontology, and the actual content. Examples of well-known ACL languages are KQML (Knowledge Query and Manipulation Language) and FIPA-ACL (Foundations for Intelligent Physical Agents-Agents Communication Language) proposed by FIPA ([18]. FIPA is the relevant standardisation body that promotes agent-based technology and the interoperability of its standards with other technologies.

### 2.3 The integration of ontology and multi-agent systems

Ontologies play an important role in enabling knowledge representation, knowledge management, and knowledge sharing. Many applications benefit greatly from making use of ontologies as a means of achieving semantic interoperability among heterogeneous and distributed systems. They are considered as one of the key enablers for the emerging Semantic Web by making the Web content accessible to humans and computers [19]. Ontologies are in a machine-understandable and processable format, thereby enabling the software agents to understand the contents autonomously. Therefore, the integration of ontologies and multi-agent systems, also known as the ontology-based multi-agent approach, allows software applications to benefit from both technologies. For instance, ontologies can assist with data retrieval, while the agents can act as autonomous software entities that can interact with the environment and with other agents [20].

In recent years, the ontology-based multi-agent approach has attracted considerable interest in research to support various works operated in distributed and dynamic environments. The majority of research has focused on the use of ontology to facilitate agents' communication, represent domain knowledge and help to locate and retrieve information, and reasoning the knowledge.

- **Facilitating agents' communication**

In a multi-agent system, each agent usually cooperates with other agents to achieve a common goal; therefore, it needs the ability to communicate and interact with other agents by exchanging messages. The agent communication languages such as KQML and FIPA-ACL specify the syntax of the exchange messages but not the semantics of the messages. In this case, ontology can be additionally supplied in the messages to formalise the semantics of the exchanged message in a format that is understandable by agents in order to facilitate consistent communication and interoperability.

- **Representing domain knowledge and helping to locate and retrieve information**

Ontology can be used to describe domain knowledge and information content which is pertinent to that domain. With the use of ontologies in MAS, domain knowledge does not need to be embedded within the agents. Therefore, it creates an opportunity to share and reuse the domain knowledge and also has the potential to reuse the MAS infrastructure for other applications. Moreover, software agents have the ability to read and understand knowledge captured in ontologies. Therefore, they are able to locate and retrieve the information requested by their user.

- Reasoning the knowledge

The use of ontologies coupled with MAS can support knowledge representation and reasoning capabilities of software applications that are developed by deploying the MAS approach. The integration of ontologies in MAS can lead to the creation of logic rules that can be applied by a semantic reasoner to infer new knowledge not explicitly defined in ontologies [21].

The benefits of both technologies can be had by integrating ontology and MAS. Ontology is used for knowledge representation, knowledge integration, knowledge sharing and reuse. The features of the software agent and MAS, such as autonomy, reactivity, pro-activeness, social ability, adaptability and dynamism, provide a potential solution for applications that are complex, dynamic and distributed. Therefore, they can be deployed in the application if only one of the approaches cannot satisfactorily resolve the problem. As the ontology and agent-based technology address different aspects of the same problem, they complement each other. Therefore, the ontology-based multi-agent system has been chosen in research as described in the next section.

### 3. Ontology-based Multi-agent Systems

From the literature, it is evident that considerable efforts have been put into the integration of ontologies and multi-agent systems, also known as ‘ontology-based multi-agent’ approaches in order to disseminate the knowledge captured in ontologies. Furthermore, some researchers have mentioned them as a means of facilitating knowledge assimilation by capturing and incorporating the knowledge into the ontology knowledge base. These works encompass various domains including software engineering, health, and education, to name a few.

In the software engineering domain, a series of researches related to ontology-based multi-agent systems to support software development activities have been undertaken. MAEST [22] is a multi-agent system that is intended to assist testers during the testing process. An ontology for software testing is developed to model several aspects related to testing software systems such as testing activities, testing methods, software artefacts, information about the environment in which testing is conducted, available resources, and the requirements of the test results. The agents use this information as a means of sharing knowledge and facilitating consistent communications.

In [23], the authors propose an ontology-based multi-agent system to provide support for remote collaboration in multi-site distributed software development environments. In this work, agents are structured into two agencies, namely, user agency and the project agency to create Collaborative Working Spheres (CSW) for software developers to obtain information related to other remote team members’ activities. A shared component ontology is created and used by the agents to facilitate consistent communication between the agents in different agencies.

Lee and Wang [24] introduce an ontology-based computational intelligent multi-agent for Capability Maturity Model Integration (CMMI) assessment. This system consists of three main agents interacting with one another to achieve the goal of effectively summarising the evaluation reports of the software engineering process in regard to CMMI assessment. The CMMI ontology is developed specifically based on the fundamental knowledge of the Process and Product Quality Assurance (PPQA) process area of CMMI. The software agents make use of the defined concepts in this ontology to extract key sentences from the evaluated reports in order to enable the relevant team members to comprehend it easily and quickly.

The integration of multi-agent systems and Software Product Lines (SPL) is addressed in [25]. It provides a solution for producing higher quality software at lower development costs and less time-to-market by taking advantage of agent technologies. The ontology is used to model the Multi-agent System Product Lines (MAS-PLs) domain. The agents use this ontology to facilitate inter-agent communication.

The authors of [26] and [27] propose a context processing mechanism called ContextP-GSD (Context Processing on Global Software Development) that utilises contextual information to assist users during the software development process. This mechanism applies agent-based technology to process contextual information and support human resource allocation.

The OntoDiSEN ontology [28] is developed to represent context information in a global software development environment. The software agents use this ontology for context information retrieval and reasoning. In addition, the authors claim that the proposed ontology agent can manipulate the ontology instance knowledge such as updating contextual information or inserting new inferred action and facts. However, no details are provided to show how the ontology agent can perform these tasks.



In [29], the authors offer a case study of an ontology-based multi-agent system in which collaborative agents are interacting and mediating with the Software Engineering Ontology to support multi-site software development teams.

For the health domain, Hadzic, Wongthongtham, Dillon and Chang [30] propose a framework to unify the multi-agent approach with the human disease ontology in order to create an intelligent information retrieval system for human disease. The proposed ontology represents the knowledge regarding human diseases. The agents make use of this ontology for information retrieval and information analysis and to facilitate consistent communications among agents and knowledge reasoning.

Wang, Lee, Hsieh, Hsu, Acampora and Chang [31] introduce an ontology-based multi-agent system for intelligent healthcare applications to assist users to evaluate diets. The ontologies have been developed to represent personal profiles and food models. Agents use these ontologies to analyse appropriate diet information based on a user profile. Li and Mackaness [32] develop a system that is based on a multi-agent architecture to support decision-making for epidemic management. The system is intended to enhance the performance of information retrieval in a dynamic decision-making environment. Inexperienced personnel can use this system to locate online data and to process services for spatio-temporal analysis of a specified environmental epidemic. Ontologies for dataset and service semantics are used to describe general concepts of GIS web service and epidemiology data management, while lightweight ontologies for simple spatial and temporal reasoning are used to add spatial and temporal semantics to the geospatial data. The agents utilise these ontologies to enable automated semantic service discovery and composition.

In educational domain, Oriche, Chekry and Khaldi [33] propose a semantic annotation system based on three main agents to manage the semantic annotation of educational resources. These agents utilise the domain ontology to assign domain knowledge to learning objects. Once these resources have been annotated, they are conceptualised and organised well so that they can be delivered to the users on demand according to their profiles and needs.

Dolia [34] presents an ontology-based multi-agent system to provide useful information regarding academic institutions such as course information, course registration and scheduling. The Academic Institute Ontology is developed to define concepts and relationships that exist in university teaching environments. The agents make use of this ontology to facilitate their understanding for consistent communication and to provide responses to various types of queries.

In [35] and [13], the authors propose an ontology-based multi-agent framework to automatically discover, compose, invoke and monitor web services. Several kinds of ontologies, namely, application and domain ontology, agent local knowledge ontology, negotiation ontology, and semantic web services ontologies are utilised in this framework. In these works, the agents make use of these ontologies to automatically discover, compose, and invoke the available web services, and to facilitate consistent agent communication. The researchers evaluated the proposed framework by applying it to the e-commerce and biology domains.

In [36], the authors develop an ontology-based multi-agent system to discover appropriate cloud services as requested by consumers. The system consists of three agents collaboratively working to provide dynamic searching for a cloud service. The Cloud Service Ontology is developed to represent cloud service description. The agents use this ontology for reasoning about the services and for information retrieval. In addition to the abovementioned works, ontology-based multi-agent approaches have been used extensively in other domains. For example, Yang, Lo and Steele [37] introduce an ontology-based multi-agent system for the accommodation services industry to support the online accommodation market. The domain ontology is used to facilitate agent communication and collaboration as well as the development of an ontology-based data transformation mechanism for data structure translation.

Ying, Ray and Lewis [38] introduce MOMA, a framework for creating ontology-based multi-agent systems, and incorporated an experiment in financial application development. MOMA consists of two main development phases: ontology development and agent development. However, the researchers focus only on the development of ontology and the use of the ontology to drive the implementation of the agent application. The agent development part is treated as a black box, but no details are provided regarding the design of the agent's application. The agents make use of the ontology to facilitate consistent inter-agent communication and coordination.

Iribarne, Padilla, Ayala, Asensio and Criado [39] propose an ontological web trading agent approach for environmental information retrieval. This work attempted to address the complexity of information retrieval in the information system to support environmental management. The ontologies used in this system are

intended for information retrieval and to facilitate agent communication. Table 2 provides a summary of the aforementioned ontology-based multi-agent systems.

**Table 2** Review of some existing ontology-based multi-agent systems

Application Domain	Source	Objectives of ontology-based multi-agent systems	Purpose of agent's use of ontology
Software Engineering	(Maamri and Sahnoun 2007) [22]	Provide assistance to software testers by automating the process of test.	<ul style="list-style-type: none"> <li>- Represent domain knowledge about software testing</li> <li>- Facilitate agent communication</li> </ul>
	(Palacio et al. 2009) [23]	Assist software development team to identify or create opportunities for remote collaboration establishment	-Facilitate consistent communication between the agents in different agencies.
	(Hadzic et al. 2009b) [29]	Provide support for multi-site software development teams as a communication framework	<ul style="list-style-type: none"> <li>- Represent software engineering domain knowledge</li> <li>- Information retrieval</li> <li>- Facilitate agent communication</li> </ul>
	(Lee and Wang 2009) [24]	Summarise the evaluation reports of the software engineering process in regard to CMMI assessment	<ul style="list-style-type: none"> <li>- Use defined concepts to extract the key sentences from the evaluated reports</li> <li>- Support reasoning of the term relation</li> </ul>
	(Nunes et al. 2011) [25]	Provide a solution for producing higher quality software at lower development costs and less time-to-market	- Facilitate inter-agent communication
	(Monte-Alto et al. 2012) [26]	Process contextual information and support human resource allocation	<ul style="list-style-type: none"> <li>- Contextual information retrieval</li> <li>- Knowledge reasoning</li> </ul>
	(Teixeira and Huzita 2014) [27]	Support human resource allocation in globally distributed software projects.	<ul style="list-style-type: none"> <li>- Information retrieval</li> <li>- Knowledge reasoning</li> <li>- Knowledge manipulation</li> </ul>
Health	(Hadzic et al. 2009a) [30]	Intelligent and dynamic information retrieval of human disease information	<ul style="list-style-type: none"> <li>- Represent medical domain knowledge regarding human diseases</li> <li>- Information retrieval and analysis</li> <li>- Facilitate agent communication</li> <li>- Knowledge reasoning</li> </ul>
	(Wang et al. 2010) [31]	Evaluate the health of diets	<ul style="list-style-type: none"> <li>- Represent personal profile and food model</li> <li>- Information analysis</li> </ul>
	(García-Sánchez et al. 2008) [35]	Dynamically retrieve biological information	<ul style="list-style-type: none"> <li>-Facilitate agent communication and coordination</li> <li>- Information retrieval</li> </ul>
	(Li and Mackaness 2015) [32]	Enhance the performance of Epidemiology information retrieval in a dynamic decision-	<ul style="list-style-type: none"> <li>- Information retrieval</li> <li>- Spatial and temporal reasoning</li> </ul>

Application Domain	Source	Objectives of ontology-based multi-agent systems	Purpose of agent's use of ontology
		making environment	
Education	(Dolia 2010) [34]	Provide useful information for users in academic institutes	- Facilitate the interactions among different agents - Information retrieval
	(Oriche, Chekry and Khaldi 2013) [33]	Automate the semantic annotation of educational resources	- Assign domain knowledge to educational resources
E-commerce	(Yang, Lo and Steele 2007) [37]	Support communication, interaction, and management among different parties engaged in the accommodation e-market	- Facilitate agent communication - Describe agent services
	(García-Sánchez et al. 2009) [13]	Facilitate the selection of the provider whose proposal best matches the users' preferences	-Facilitate agent communication and coordination - Information retrieval
Finance	(Ying, Ray and Lewis 2013) [38]	Automate some market analysis tasks	- Represent financial domain knowledge - Facilitate agent's communication and collaboration
Environment	(Iribarne et al. 2014) [39]	Address the complexity of information retrieval in the information system supporting environment management	- Information retrieval - Facilitate agent communication
Cloud service	(Parhi, Pattanayak and Patra 2015) [36]	Discover appropriate cloud services as requested by consumers	- Represent cloud service description - Reasoning - Information retrieval

#### 4. Discussion and open research issues

In this section, with the survey conducted in the previous section, we will discuss the open issues that can be addressed to help to increase the quality of future ontology-based multi-agent systems. Although there is substantial literature on ontology-based multi-agent systems, the existing approaches have two shortcomings that this paper intends to address, namely, the ontology-based multi-agent system for manipulating ontology instances, and the ontology-based multi-agent system that can provide support covering various activities in the software development life cycle.

First, in the literature, most of the ontology-based multi-agent systems focus on facilitating the dissemination of knowledge captured in the ontology. However, very little attention has been paid to utilising the ontology-based multi-agent approach for assimilating knowledge captured in the ontology, i.e., the ontology instantiation manipulation. The purposes for which the software agents make use of the ontology can be categorised as follows:

- representing application and domain knowledge (e.g., [22], [29], [24], [31], [38], [36])
- locating and retrieving the information (e.g., [13], [26], [29], [30], [32], [35], [39])
- reasoning the knowledge (e.g., [26], [27], [29], [32], [35], [39])
- facilitating agents' communication (e.g., [22], [37], [13], [34], [25], [38], [39])
- Maamri and Sahnoun 2007; Yang, Lo and Steele 2007; García-Sánchez et al. 2008; Hadzic et al. 2009a; Hadzic et al. 2009b; Palacio et al. 2009; García-Sánchez et al. 2009; Dolia 2010; Nunes et al. 2011; Ying, Ray and Lewis 2013; Iribarne et al. 2014); and
- facilitating semantic annotation of resources (e.g., [33]).

Although some research (e.g., [26],[27]) mentions the utilising of software agents to manipulate the ontology instantiations, no details or supporting information are provided to explain how the agents work on the ontology manipulation task. Because software agents are able to read and reason published knowledge with the

guidance of the ontology [29], it would be a challenge to utilise the ontology-based multi-agent approach for assimilating knowledge in order to manage the evolution of ontology instantiations.

Second, over recent years, the deployment of ontology-based multi-agent systems for effectively disseminating software development knowledge to support software team members has become more prevalent. Nevertheless, many of the works are specific in that they address only a particular task or a certain issue. Thus, it would be a challenge to investigate the use of the ontology-based multi-agent approach to provide useful support for software development team that can cover several tasks spanning the software life cycle.

## 5. Conclusion and future work

In this paper, we have summarized state of the art ontology-based multi-agent systems proposed in several domains. From the survey, we identify some open research issues for the future research on the ontology-based multi-agent systems. In the future work, we outline the motivation of our research on developing a novel methodology to use utilise the ontology-based multi-agent approach for assimilating knowledge in order to manage the evolution of ontology designed for multi-site software development instantiations.

## References

- [1] M. Wooldridge, *An Introduction to Multiagent Systems*: John Wiley & Sons, 2009.
- [2] M. Wooldridge, and N. R. Jennings, "Intelligent agents: Theory and practice," *The knowledge engineering review*, vol. 10, no. 02, pp. 115-152, 1995.
- [3] N. R. Jennings, "On agent-based software engineering," *Artificial Intelligence*, vol. 117, no. 2, pp. 277-296, 2000.
- [4] E. Turban, R. Sharda, and D. Delen, *Decision Support and Business Intelligence Systems*: Prentice Hall Press, 2010.
- [5] L. Braubach, A. Pokahr, D. Bade, K.-H. Krempels, and W. Lamersdorf, "Deployment of distributed multi-agent systems," *Engineering Societies in the Agents World V: 5th International Workshop, ESAW 2004, Toulouse, France, October 20-22, 2004. Revised Selected and Invited Papers*, M.-P. Gleizes, A. Omicini and F. Zambonelli, eds., pp. 261-276, Berlin, Heidelberg: Springer Berlin Heidelberg, 2005.
- [6] D. Ye, M. Zhang, and A. V. Vasilakos, "A Survey of Self-Organization Mechanisms in Multiagent Systems," *IEEE Transactions on Systems, Man, and Cybernetics: Systems*, vol. PP, no. 99, pp. 1-21, 2016.
- [7] A. H. Elamy, "Perspectives in agent-based technology," *AgentLinkNews*, vol. 18, pp. 19-22, 2005.
- [8] K. Terje, and D. Marius, "Design and development of a multi-agent e-learning system," *International Journal of Agent Technologies and Systems (IJATS)*, vol. 7, no. 2, pp. 19-74, 2015.
- [9] H. A. Rady, "Multi-agent system for negotiation in a collaborative supply chain management," *International Journal of Video & Image Processing and Network Security IJVIPNS-IJENS*, vol. 11, no. 5, 2011.
- [10] R. Zimmermann, *Agent-based Supply Network Event Management*, Switzerland: Birkhäuser Verlag, 2006.
- [11] L. D. Ngan, and R. Kanagasabai, "Semantic Web service discovery: State-of-the-art and research challenges," *Personal and Ubiquitous Computing*, vol. 17, no. 8, pp. 1741-1752, 2013.
- [12] G. Mohamed, and D. Makhlof, "To implement an open-MAS architecture for Semantic Web services discovery: what kind of P2P protocol do we need?," *International Journal of Agent Technologies and Systems (IJATS)*, vol. 3, no. 6, pp. 58-71, 2014.
- [13] F. García-Sánchez, R. Valencia-García, R. Martínez-Béjar, and J. T. Fernández-Breis, "An ontology, intelligent agent-based framework for the provision of Semantic Web services," *Expert Systems with Applications*, vol. 36, no. 2, Part 2, pp. 3167-3187, 3//, 2009.
- [14] A. Dolgui, J. Sasiadek, M. Zaremba, N. Benhajji, D. Roy, and D. Anciaux, "15th IFAC Symposium on Information Control Problems in Manufacturing Patient-centered multi agent system for health care," *IFAC-PapersOnLine*, vol. 48, no. 3, pp. 710-714, 2015/01/01, 2015.
- [15] E. Shakshuki, and M. Reid, "Multi-agent system applications in healthcare: Current technology and future roadmap," *Procedia Computer Science*, vol. 52, pp. 252-261, 2015.
- [16] D. Isern, D. Sánchez, and A. Moreno, "Agents applied in health care: A review," *International Journal of Medical Informatics*, vol. 79, no. 3, pp. 145-166, 3//, 2010.

- [17] S. Vaniya, B. Lad, and S. Bhavsar, "A Survey on Agent Communication Languages," in International Conference on Innovation, Management and Service, Singapore, 2011.
- [18] "The Foundation for Intelligent Physical Agents," January 5, 2016; <http://www.fipa.org>.
- [19] L. Li, B. Wu, and Y. Yang, "Agent-based ontology integration for ontology-based applications," in Proceedings of the 2005 Australasian Ontology Workshop - Volume 58, Sydney, Australia, 2005, pp. 53-59.
- [20] N. O. Garanina, E. A. Sidorova, and E. V. Bodin, "A multi-agent approach to unstructured data analysis based on domain-specific ontology." pp. 122-132.
- [21] A. Freitas, A. R. Panisson, L. Hilgert, F. Meneguzzi, R. Vieira, and R. H. Bordini, "Integrating ontologies with multi-agent systems through CArTAgo artifacts." pp. 143-150.
- [22] R. Maamri, and Z. Sahnoun, "MAEST: multi-agent environment for software testing," Journal of Computer Science, vol. 3, no. 4, pp. 249-258, 2007.
- [23] R. R. Palacio, A. L. Moran, V. M. Gonzalez, and A. Vizcaino, "Providing Support for Starting Collaboration in Distributed Software Development: A Multi-agent Approach." pp. 397-401.
- [24] C.-S. Lee, and M.-H. Wang, "Ontology-based computational intelligent multi-agent and its application to CMMI assessment," Applied Intelligence, vol. 30, no. 3, pp. 203-219, 2009/06/01, 2009.
- [25] I. Nunes, C. P. Lucena, U. Kulesza, and C. Nunes, "On the development of multi-agent systems product lines: A domain engineering process," Agent-Oriented Software Engineering X, Lecture Notes in Computer Science, pp. 125-139: Springer Berlin Heidelberg, 2011.
- [26] H. Monte-Alto, A. Biasão, L. Teixeira, and E. Huzita, "Multi-agent applications in a context-aware global software development environment distributed computing and artificial intelligence," Advances in Intelligent and Soft Computing, pp. 265-272: Springer Berlin / Heidelberg, 2012.
- [27] L. O. Teixeira, and E. H. M. Huzita, "DiSEN-AlocaHR: A multi-agent mechanism for human resources allocation in a distributed software development environment," Distributed Computing and Artificial Intelligence, 11th International Conference, S. Omatu, H. Bersini, M. J. Corchado, S. Rodríguez, P. Pawlewski and E. Bucciarelli, eds., pp. 227-234, Cham: Springer International Publishing, 2014.
- [28] A. P. Chaves, I. Steinmacher, L. Leal, G. Camila, E. H. M. Huzita, and A. B. Biasão, "OntoDiSENv1: An ontology to support global software development," CLEI Electronic Journal, vol. 14, no. 2, pp. 2-2, 2011.
- [29] M. Hadzic, P. Wongthongtham, T. Dillon, and E. Chang, "Case study II: Ontology-based multi-agent system for software engineering studies," Ontology-Based Multi-Agent Systems, Studies in Computational Intelligence, pp. 217-270: Springer, 2009.
- [30] M. Hadzic, P. Wongthongtham, T. Dillon, and E. Chang, "Case Study I: Ontology-Based Multi-Agent System for Human Disease Studies," Ontology-Based Multi-Agent Systems, Studies in Computational Intelligence, pp. 179-216: Springer Berlin Heidelberg, 2009.
- [31] M.-H. Wang, C.-S. Lee, K.-L. Hsieh, C.-Y. Hsu, G. Acampora, and C.-C. Chang, "Ontology-based multi-agents for intelligent healthcare applications," Journal of Ambient Intelligence and Humanized Computing, vol. 1, no. 2, pp. 111-131, 2010.
- [32] S. Li, and W. A. Mackaness, "A multi-agent-based, semantic-driven system for decision support in epidemic management," Health Informatics Journal, vol. 21, no. 3, pp. 195-208, September 1, 2015, 2015.
- [33] A. Oriche, A. Chekry, and M. Khaldi, "Intelligent agents for the semantic annotation of educational resources," International Journal of Soft Computing and Engineering (IJSCE) vol. 3, no. 5, pp. 2231-2307, 2013.
- [34] P. M. Dolia, "Integrating ontologies into multi-agent systems engineering (MaSE) for university teaching environment," Journal of Emerging Technologies in Web Intelligence, vol. 2, no. 1, pp. 42-47, 2010.
- [35] F. García-Sánchez, J. T. Fernández-Breis, R. Valencia-García, J. M. Gómez, and R. Martínez-Béjar, "Combining semantic web technologies with multi-agent systems for integrated access to biological resources," Journal of Biomedical Informatics, vol. 41, no. 5, pp. 848-859, 10//, 2008.
- [36] M. Parhi, B. K. Pattanayak, and M. R. Patra, "A multi-agent-based framework for cloud service description and discovery using ontology," Intelligent Computing, Communication and Devices: Proceedings of ICCD 2014, Volume 1, C. L. Jain, S. Patnaik and N. Ichalkaranje, eds., pp. 337-348, New Delhi: Springer India, 2015.

- [37] K. Yang, A. Lo, and R. Steele, "An Ontology-based Multi-Agent System for the Accommodation Industry," in *The Thirteenth Australasian World Wide Web Conference, AusWeb07*, New South Wales, Australia, 2007, pp. 193-205.
- [38] W. Ying, P. Ray, and L. Lewis, "A methodology for creating ontology-based multi-agent systems with an experiment in financial application development," in *System Sciences (HICSS), 2013 46th Hawaii International Conference on*, Wailea, Maui, Hawaii, USA, 2013, pp. 3397-3406.
- [39] L. Iribarne, N. Padilla, R. Ayala, J. A. Asensio, and J. Criado, "OntoTrader: An ontological web trading agent approach for environmental information retrieval," *The Scientific World Journal*, vol. 2014, pp. 25, 2014.
- [40] H. Hammouch, H. Medromi, and A. Sayouti, "Toward an intelligent system for project management based on the multi agents systems." pp. 1-6.

## Evaluation of Linux I/O Schedulers on SSD for HDFS

Kritwara Rattanaopas<sup>1,\*</sup>, Sureerat Kaewkeeree<sup>2</sup>, Sarapee Chunkaew<sup>1</sup> and  
Supawadee Mak-on<sup>3</sup>

<sup>1</sup> Computer Department, Faculty of Science and Technology, Songkhla Rajabhat University,  
Songkhla, Thailand

<sup>2</sup> Department of Computer Engineering, Faculty of Engineering, Prince of Songkla University  
Hatyai, Thailand

<sup>3</sup> Department of industrial, Rajamangala University of Technology Srivijaya Rattaphum College

### Abstract

HDFS is base storage of Hadoop cluster and it directly affects Hadoop performance. This research focuses on HDFS storage and we purpose Linux disk scheduler for increasing HDFS storage performance in virtualization environment and SSD. We use TestDFSIO to evaluate Linux disk scheduler with HDFS storage over SSD and use Flexible IO to compare HDFS storage performance with local SATA disk and NFSv4-SSD. In HDFS storage, we use Linux disk scheduler include CFQ, NOOP and Deadline. The results show that HDFS storage performance has better performance than NFSv4-SSD with NOOP and Deadline schedulers. Also, their performance has a better than local with SATA disk. Moreover, we create a fail scenario which shot down one data node when use Flexible IO. The results present a similar performance as other HDFS storages. In TestDFSIO, Deadline has more performance than other disk schedulers. Moreover, the least IO performance of disk scheduler is CFQ. In Flexible IO, Hadoop's NFSv3 gateway is mounted by client and evaluated by FIO read command. The results show HDFS storage cases having similar performance to NFSv4-SSD.

**Keywords:** HDFS, CFQ, Deadline, NOOP, TestDFSIO

### 1. Introduction

Storage is a basic device for all computers. There are also various types of storage. The network attach storage is one of the most popular type since a study of the Internet Data Center (IDC) found that the capacity of a new storage can grows up to 100TB. In Big Data era, the new storage platforms or models has been proposed including Amazon (DynamoDB), MongoDB, DataStax (Distribution of Apache Cassandra), Amazon (EMR), Cloudera (Hadoop), Hortonworks (Hadoop), MapR (Hadoop), Microsoft (HDInsight), and Pivotal (HD). Nowadays, many open-source storages are based on Hadoop HDFS. It has a reliable disk cluster because its architecture is the distributed technology that distributed raw data across all nodes. HDFS is based on Google's GFS (Google File System), it combines all physical redundant storages to one logical amount of data. All Service of data center can attach HDFS storage with Network File System (NFS) or Filesystem in Userspace (FUSE). Moreover, it can provide data over HTTP which is called Hadoop HDFS over HTTP (HttpFS). The last one, NFS gateway of HDFS is easy to use and customize for all services similar to NFS server in data center. This research chooses NFSv3 gateway to evaluate the distributed network storage which is the most popular storage along others distributed storage (e.g. Ceph [7] and GlusterFS [8]) because HDFS use to store data for Hadoop. It has more challenge to improve the performance because its performance will directly affect Hadoop performance.

HDFS node must assign directory path for storing data. On each node, it has the various types of disk scheduler including CFQ, NOOP and Deadline. The Linux disk schedulers are one of the popular topics in Virtualization's researches [1][2] which found a better performance by using disk scheduler with virtual machine. They attempt to use disk scheduler with Solid State Disk (SSD) in the virtualization environment. SSD is a new type of disk storage providing high-IOPS for enterprise storage device. It also uses semiconductor devices (solid state memory). The benefit of using SSD is a fast-access like memory or RAM-disks because it is based on Dynamic Random Access Memory (DRAM). Even though it has a better performance than the magnetic disk, but its price is extremely expensive. In Big Data era with Linux I/O Schedulers, we can increase performance with the configuration of disk storage by using Linux disk scheduler on various types of the Big data processing including Terasort, Wordcount and TestDFSIO in Hadoop. In best practices of Hadoop

---

\* Corresponding author; e-mail: kritwara.ra@skru.ac.th

performance-tuning [3], researchers suggested to use the Linux disk scheduler in OS Configuration Tuning topic. This research has the current hypothesis about using Linux disk scheduler with SSD in order to evaluate a storage performance of HDFS storage. In Young Jin Yu's research 0 can increase a disk performance of SSD with block I/O scheduler that not only SSD has a benefit from I/O performance but also we can investigate Linux disk scheduler to improve better than default performance with SSD. Linux disk scheduler is the most popular method which is intermediate software between operating system layer and physical storage device. In this research, we use the virtualization environment of Kernel-based Virtual Machine (KVM) which is the most popular of open-source virtualizations. It is also supported in OpenStack. In Amazon EMR, it is the most popular web service based on Hadoop on virtualization environment same environment as this research. Amazon's Hadoop services are fast and cost-effective to use Big Data analytic. By the motivation of the similarity of the idea to this research, we deploy test-bed architecture in the private cloud by using KVM.

This research is including Background review and related works, Materials and methods, Evaluation and Conclusion. This session related work and background information (e.g. HDFS, Linux disk scheduler and NFS). All Linux disk schedulers with HDFS storage are describe in our methodology. In evaluation, we use Hadoop benchmark and Flexible IO for file benchmark in every scenario. In concluding, we present a performance and future works.

## 2. Research objective(s)

To present a comparison of storage performance on SSD by using Linux disk scheduler in Hadoop HDFS storage.

## 3. Background and related work

This section, we review the related components of this research including Hadoop, Hadoop Distributed File System, Linux disk scheduler, Network file system and Flexible IO. In related work, we describe related topic in distributed storage with Linux disk scheduler.

### 3.1 Hadoop

Currently, Big data analytic is the most popular topic in Big data processing. Hadoop cluster is the best answer for this solution and widely used with commercial support which include Cloudera, Hortonworks and MapR. It is not only contributed by Apache which is the creator and the original developer of Hadoop. Hadoop is a portable program over the Java JDK. The Hadoop Distributed File System (HDFS) is a logical storage that is created from local directory on each node of Hadoop cluster. Moreover, Hadoop has more various softwares including Hive which is a relational warehouse, R Connectors for Statistic function with R language and Mahout which is machine learning. Hadoop architecture is shown in Figure 1. It has three frameworks include MapReduce, Tez and Spark for Big data process.

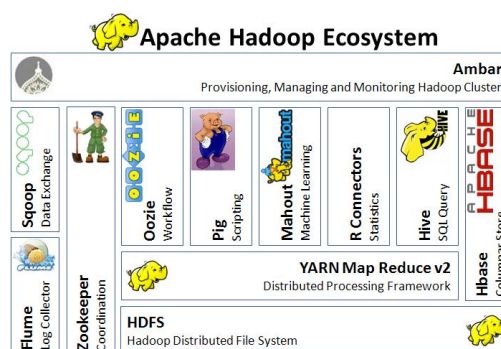


Figure 1 Hadoop Ecosystem [4]

### 3.2 Hadoop Distributed File System (HDFS)

Apache Hadoop is a cluster of nodes that is possible to scale. Hadoop Distributed File System (HDFS) [6] is the most popular storage service of Hadoop. It includes Name node for containing namespace of HDFS and Data node for storing block replicate of HDFS file. For high availability, data in HDFS cluster can lost in some blocks when a Data node downs and other Data nodes can distribute same blocks by using replicate. The goal of HDFS is to use available a lot of nodes in a large cluster with inexpensive disk storages for maintaining high availability and high performance. HDFS storage is known as data locality and can integrate to a storage area network (SAN), or network attached storage (NAS). It provides large size of storage by using inexpensive



drive and server over Hadoop cluster. The data in HDFS is divided into blocks and copied to each Data node in cluster. It is actually stored as small blocks and replicated on each Data node. HDFS architecture on cluster can be described as follows:

NameNode is the HDFS namespace. It includes a hierarchy of files and directories in HDFS logical drive. HDFS's files and directories are represented by inode records. They are split into blocks and replicated to Data nodes.

Image and Journal represent inode and the list of blocks that define the metadata of image. It stores the entire namespace image of inode in memory. Journal represents location of block replicates. It is flushed and synced before acknowledging to client when each client initiates a transaction.

DataNodes store each block replicate that they are represented by two files in local filesystem or DFS's datanode folder as follows: The first file is raw block data and the second file stores the block's metadata with checksums.

### 3.3 Linux disk scheduler

Linux disk scheduler [5] is the best practice for disk performance in CentOS that has three I/O schedulers including Completely Fair Queuing (CFQ), NOOP and Deadline. We describe all I/O schedulers as follows:

Completely Fair Queuing (CFQ), this scheduler provides the fairness scheduler by supporting multiple processes integrated into Linux kernel 2.6.23 and selected to be the default scheduler of Red Hat Enterprise Linux 6 I/O scheduler. It has 3 scheduler classes including real-time, best-effort and idle. The default of CFQ is the best-effort class. The real-time class can starve out I/O and perform with load, but the idle class only serves if other I/O is pending. CFQ assigns a time slice to each I/O process to take fairness. All I/O processes can have up to 8 requests and CFQ tries to predict an application. Also, CFQ makes more I/O processes.

Noop, the simplest I/O scheduler by using first-in first-out (FIFO) scheduling. It can merge individual requests at the block layer. Noop is the best I/O scheduler for making systems with fast storage.

Deadline, it aims to guarantee latency for I/O processes. Deadline assigns an expiration time for each device by focusing on an expiration time of requests. For example, more similar requests at close disk locations will be serviced for better efficiency and reading processes have a high priority over writing processes.

### 3.4 Network File System (NFS)

NFS is the most popular network attached storage that uses mount command to attach server storage over a network with those file systems. Currently, NFS has three versions including NFS version 2 (NFSv2 use RFC-1094), NFS version 3 (NFSv3 use RFC-1813) and NFS version 4 (NFSv4 use RFC-7530). NFSv2 is older and widely used. NFSv3 has more features with 64 bits file and Async mode to write data. Latest, NFSv4 can work on firewall with port mapper and ALC. NFS uses Transmission Control Protocol (TCP) over IP but NFSv2 and NFSv3 can use User Datagram Protocol (UDP) which their connection under normal conditions has less Protocol overhead than TCP.

### 3.5 Flexible IO

Flexible IO [9] is represented by fio command that is a special test case program. It can create workload in any number of threads or processes and simulate an I/O workload. It can measure both the quantity and depth of storage including high-performance storage devices such as PCIe or high-performance network storage over long time period. It can be tested in multiple threads with depth profiles and produce the results which include Throughput, Average Latency, Max Latency and Latency Standard Deviation. For enterprise, it has a synthetic workload analysis which includes different profiles as real-world tasks. For example, read and write speed 70/30 in 8k is widely used for enterprise hardware.

### 3.6 Related work

Linux disk scheduler on SSD is the most popular in a new data center with virtualization technology. In Shrinivas B. Joshi research [3] related to Hadoop performance-tuning suggested by using I/O schedulers for improving the performance in OS Configuration Tuning. There were also other techniques proposed by him such as BIOS, OS, JVM and Hadoop configuration parameters. Those techniques are possible to increase performance of Hadoop cluster. Kenji Nakashima et al. [2] improved I/O performance of Hadoop cluster by static method and striping layout ST2 with EXT3 file system. They evaluated I/O performance by using Hadoop benchmark including TeraSort and TestDFSIO in virtualized environment. In Big data, Abdelmounaam Rezgui et al. [1] used Hadoop cluster with Linux I/O schedulers including CFQ, Deadline, Noop and Anticipatory on the Global Environment for Network Innovations (GENI). Their results with Hadoop benchmark showed a little difference in performance in default parameters on each scheduler. That research focused on Linux I/O schedulers on SSD for improving I/O performance in Hadoop cluster. The test-bed

architecture used a virtualization of KVM and Hadoop NFSv3 gateway which used to share HDFS storage for other services in data center. We do not only evaluate I/O performance on Hadoop cluster, but we also evaluate HDFS storage via NFSv3 gateway from client's mount with flexible IO benchmark.

#### 4. Materials and methods

In this section, we describe our test-bed HDFS storage on Hadoop cluster architecture. We design the test scenarios to investigate the disk performance on virtualization with Linux disk scheduler on KVM virtual machines.

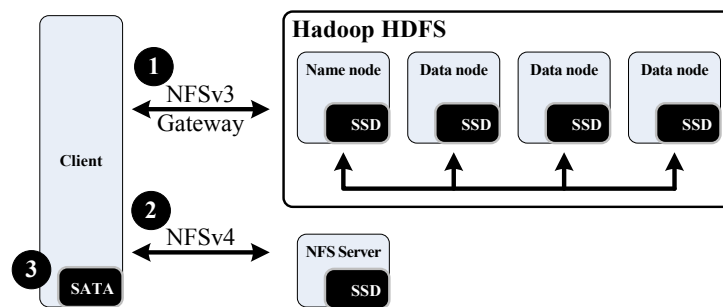
##### 4.1 Experiment Setup

We investigate HDFS storage over Hadoop cluster by using 4 virtual machines (1 name node and 3 data nodes) on full virtualization of KVM hypervisor in 2 desktop computers. Each desktop computer has Intel i7-2600 Quad core @ 3.40 GHz which enabled Intel-VT, 4 GB DDR3, 500 GB SATA and 128 GB SSD shown in Figure 2. Our HDFS storage cluster architecture is described as follows:

Master Node employed only 1 big virtual machine in Host01 with 2 vCPU and 2 GB RAM

Data Node involved 3 virtual machines on each physical Host01 and Host02 with 2 vCPU and 2 GB RAM

In Software components of physical Host machine, they installed CentOS 7.2 64 bits with KVM virtualization software. The image of virtual machines stored in SSD with XFS partition. All of virtual machines installed CentOS 7.2 64 bits, Java JDK version 1.8 and Hadoop version 2.8.2



**Figure 2** Test-bed architecture of the 3 storage scenarios

In Figure 2, it presents 3 scenarios of a comparison of storage performance which include HDFS storage, NFSv4 with SSD and local SATA storage. In No. 1, it is HDFS storage. We installed Hadoop 2.8.2 in Name node and three Data nodes with 3 replicates. Client can mount with “nfs ver=3”. In this scenario, we compared the I/O performance of three disk schedulers which include CFQ, Noop and Deadline. In No. 2, we investigated NFSv4 on SSD storage. The last one used a local SATA disk showed as No. 3. We evaluated 3 storage scenarios by using Flexible IO's read feature.

##### 4.2 HDFS with NFS3 gateway

NFSv3 gateway allows HDFS that can mount as part of client. It supports and enables as follows:

Client can browse HDFS's file and directory on NFSv3 mount path with compatible OS

Client can download and upload file from HDFS to local file system.

Client can stream data directly to HDFS. File append is supported but random write file is not supported.

HDFS used Name node for start NFSv3 gateway service with portmap as following command:

“hdfs start portmap” for initiation portmap

“hdfs start nfs3” for starting nfs version 3 service of HDFS root directory “/”

##### 4.3 Workload

We have 2 scenarios of workload can described as follows:

TestDFSIO, it is native disk benchmark of Hadoop. We used 10 job with 500 Megabytes file for evaluate read performance of HDFS storage with three disk scheduler including CFQ, NOOP and Deadline

Flexible IO, it is the most popular file benchmark. We used 128 Megabytes file and 10 step for iodept to compared read performance between local SATA disk, NFSv4 with SSD and various HDFS storage cases.

In both scenarios, we used three disk schedulers which include CFS, NOOP and Deadline. Command of disk scheduler can be described as follows:

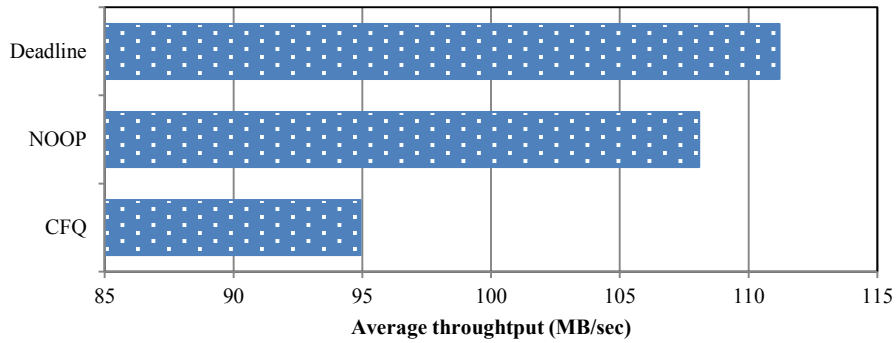
Checking disk scheduler command is “cat /sys/block/sdf/queue/scheduler”

Editing disk scheduler command is “echo 'cfq' > /sys/block/sdf/queue/scheduler”

For special case, we took a fail of one data node for evaluating an available performance of HDFS in Flexible IO.

**5. Results and discussion**

We conducted experiment to improve the I/O performance of HDFS with NFSv3Gateway by using Linux disk scheduler. Our system architecture uses Hadoop cluster in KVM as same as cloud solution including a single Master node virtual machine and multiple Data node virtual machines on a SSD storage. The results of I/O performance include average throughput of read data processes by using TestDFSIO shown in Figure 3, I/O throughput by Flexible IO shown in Figure 4, Bandwidth by Flexible IO shown in Figure 5 and IOPS by Flexible IO shown in Figure 6. In Flexible IO, we use 128 MB file for time base evaluation. The iodepth parameter is set as 10.

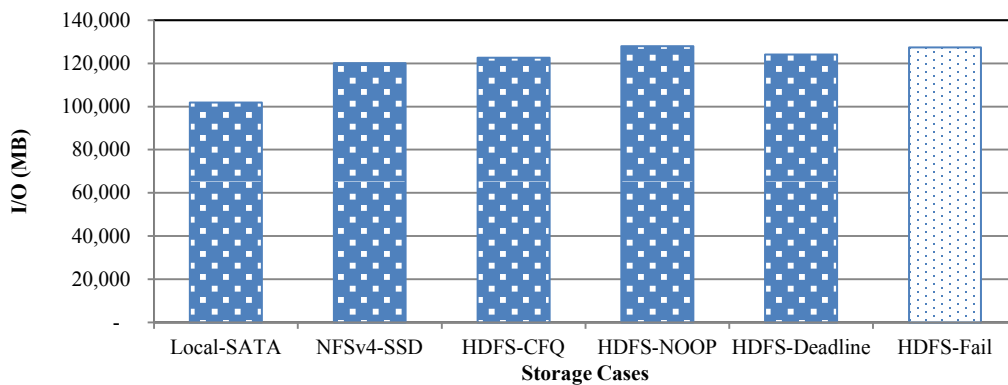


**Figure 3** Average throughput of TestDFSIO in read data processes with three Linux disk schedulers

Figure 3 shows the average read rate by using TestDFSIO. This testing evaluates the three types of disk scheduler which include CFQ, NOOP and Deadline on SSD storage. Deadline provides the better performance than NOOP and CFQ around 110 MB/sec. CFQ has the least performance of disk scheduler around 95 MB/sec which is the same as the result in Abdelmounaam Rezgui et al. [1]. They also found that CFQ using default value providing poorer performance than others disk scheduler. The results represent NOOP and deadline schedulers can increase performance. Currently, CFQ is a default value of all operating system (e.g. CentOS, Redhat Enterprise and Fedora).

**5.2 I/O results of Flexible IO**

All of results of I/O performance with Flexible IO at 128MB that HDFS storage has a better performance as same as NFSv4 with SSD shown in Figure 4.

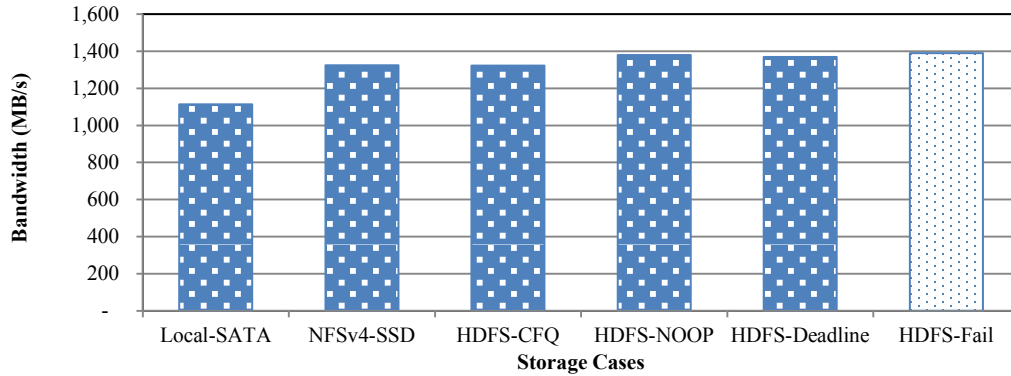


**Figure 4** I/O throughput of storage cases

In Figure 4, the results show the best I/O in HDFS storage with NOOP disk scheduler 128,021 MB. The least performance in Local storage with SATA disk 101,790 MB. For HDFS storage with fail of one data node 127,387 MB that it can keep I/O performance during test period. HDFS with three scheduler have a quite similar I/O performance same as NFSv4 with SSD that they are around 120,000 MB.

### 5.3 Bandwidth results of Flexible IO

All of results of bandwidth by using Flexible IO at 128MB that HDFS storage has a better performance as same as NFSv4 with SSD shown in Figure 5.

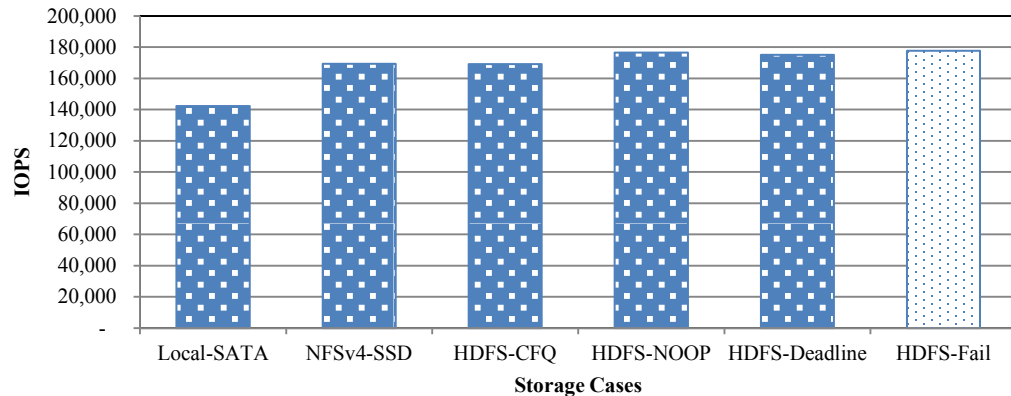


**Figure 5** Bandwidth of storage cases

In Figure 5, the best bandwidth can show in HDFS storage with all types of disk scheduler and in case of fail of one data node. Their results are around 1,300 MB per second. The least performance is local with SATA disk same as previous results in I/O performance. All of HDFS storage cases are a quite similar to NFSv4 with SSD.

### 5.4 IOPS results of Flexible IO

The last one, IOPS results of Flexible IO at 128MB that HDFS storage still has a better performance as same as NFSv4 with SSD shown in Figure 5.



**Figure 6** IOPS performance of storage cases

In Figure 6, the best bandwidth can show in HDFS storage with NOOP disk scheduler 176,554 IOPS and the least one still is local with SATA 142,345 IOPS. This result shows the available performance of HDFS in case fail of one data node that has a similar performance with other HDFS storage cases. All HDFS storage on SSD with schedulers has a similar performance with only SSD but HDFS storage has high availability and can keep IOPS in fail case.

## 6. Conclusions

In concluding, we investigated disk scheduler with SSD which is the fast storage device that can be used to improve IO performance of HDFS storage. The results show NFSv3 gateway with HDFS storage performance has a quite similar performance NFSv4 with single SSD. Moreover, HDFS fail case with SSD can keep performance like other storage cases. The results were represented by the two HDFS's benefits of purpose

method including; First, NFSv3 gateway with HDFS storage can keep performance same as a single SSD with NFSv4. Second, Linux disk scheduler can improve I/O performance for HDFS storage shown in Figure 4, Figure 5 and Figure 6. The results show that the Noop and Dead line schedulers have better than CFQ and a single SSD with NFSv4. The I/O performance by using Flexible IO, we show a comparison between a local SATA disk with others HDFS storage case on SSD. This research only evaluated a HDFS disk performance with SSD. HDFS performance can increase with others method. For example, disk policy storage. It can swap block data on various disk types including DISK, SSD and RAM. Moreover, Nfsv3 software can use UDP protocol which is challenging to deploy and evaluate performance. The pass-through method with native storage device of QEMU is suggested to increasing storage performance in more researched field related to the performance of HDFS storage. It has more challenges to improve in the future.

### Acknowledgements

The authors would like to acknowledge Faculty of Science and Technology, Songkhla Rajabhat University, Thailand for support of this research.

### References

- [1] Rezgui A, White M, Rezgui S, Malik Z. Evaluation of Linux I/O Schedulers for Big Data Workloads. In: 2014 IEEE Fourth International Conference on Big Data and Cloud Computing. 2014. p. 227-34.
- [2] Nakashima K, Fujishima E, Yamaguchi S. File Placing Control for Improving the I/O Performance of Hadoop in Virtualized Environment. In: 2016 Fourth International Symposium on Computing and Networking (CANDAR). 2016. p. 402-7.
- [3] Joshi SB. Apache Hadoop Performance-tuning Methodologies and Best Practices. In: Proceedings of the 3rd ACM/SPEC International Conference on Performance Engineering. Internet. New York, NY, USA: ACM; 2012. cited 2017 Oct 31. p. 241-242. ICPE '12. (Available from: <http://doi.acm.org/10.1145/2188286.2188323>)
- [4] Apache Hadoop. Retrieved from Hadoop: <http://hadoop.apache.org>. accessed May 18, 2017.
- [5] Red Hat Inc., Red Hat Enterprise Linux 6, Performance Tuning Guide. Retrieved from Technical White Paper: [https://access.redhat.com/documentation/en-US/Red\\_Hat\\_Enterprise\\_Linux/6/html/Performance\\_Tuning\\_Guide/ch06s04.html](https://access.redhat.com/documentation/en-US/Red_Hat_Enterprise_Linux/6/html/Performance_Tuning_Guide/ch06s04.html). accessed May 18, 2017.
- [6] IBM Analytics. HDFS. Retrieved from Hadoop Distributed File System: <https://www.ibm.com/analytics/us/en/technology/hadoop/hdfs>. accessed May 18, 2017.
- [7] Inktank Storage, Inc. and contributors. Ceph Filesystem. Retrieved from: <http://docs.ceph.com/docs/jewel/cephfs/>. (accessed May 18, 2017)
- [8] Red Hat, Inc. The Gluster Blog. Retrieved from: <https://www.gluster.org/gluster-monthly-newsletter-november-2017/>
- [9] StorageReview.com. Fio -Flexible I/O Tester Synthetic Benchmark: [http://www.storagereview.com/fio\\_flexible\\_i\\_o\\_tester\\_synthetic\\_benchmark/](http://www.storagereview.com/fio_flexible_i_o_tester_synthetic_benchmark/). accessed May 18, 2017.
- [10] Young JY, Dong IS, Woong S, Nae YS, et al. Optimizing the Block I/O Subsystem for Fast Storage Devices. Internet. cited 2017 Dec 3. (Available from: <https://dl.acm.org/citation.cfm?id=2619092>)

# Social Media Framework Incorporating Fuzzy Regression for Affective Design: State-of-the-art, Challenges, and Opportunities.

Pratima Jain<sup>1,\*</sup>, Pornpit Wongthongtham<sup>1,\*</sup> and Kit Yan Chan<sup>2,\*</sup>

<sup>1</sup>School of Information Systems, Curtin University, Perth, Australia

<sup>2</sup>Department of Electrical and Computer Engineering, Curtin University, Perth, Australia

## Abstract

Nowadays, social media has become an integral part of business, providing a platform to communicate, integrating customers directly into business procedures and acting as an information pool. However, to ensure the accuracy of information taken from social media sites, it is essential to combine information from multiple channels; this aids the legitimacy of the information extracted. Social media data analytics contribute to a variety of domains such as tourism, government, politics and product co-creation among others. In the ground of new product development, the key to the success of a new product is the ability to capture the voice of consumers. In recent years, users have become concerned not only with the basic functional attributes of a new product they might be purchasing, but also the affective attributes of the product. For example, users are more concerned about the colour, shape, look and feel, of a product (such as the affective design and quality of cars, smart phones etc.). Hence affective design is essential in new product development.

In the development or evaluation of a new product's affective design, the voice of consumers can be derived through various social media networks including product review blogs and product discussion groups. Using data from social media networks, it is possible to extract opinion information regarding the affective satisfaction of a product. However, as a user's opinion is subjective, social media data has a level of uncertainty. Therefore, the evaluation of human perception requires estimation of the amount of uncertainty in human evaluations. This paper utilises social big data to extract precise affective design values and uncertainty in evaluating affective quality from user's product related opinion. To evaluate the amount of uncertainty in human perception or subjective judgement of social media data, the proposed framework will incorporate fuzzy regression techniques. A novel algorithm based on fuzzy regression techniques is suggested to determine affective quality magnitudes and uncertainty factor in evaluating affective quality. Finally, the effectiveness of the proposed framework is proposed to be evaluated and validated based on a case study on affective car design by using car design attributes as independent variables to predict affective design value as dependent variable. Towards the study aim, this paper reviews four major streams of project i.e. (i) social media, (ii) data fusion, (iii) affective design, and (iv) fuzzy regression.

**Keywords:** Affective Design, Uncertainty, Social media analytics, Fuzzy Regression, Data Fusion.

## 1. Introduction

The rapid rise in social media use has revolutionised the power of expression in recent times. The development of the internet and expansion of mobile technologies have been the primary force behind the rise of social media use, providing technological platforms for information dissemination, content generation, and interactive communications [1]. Continually, social media is spreading worldwide at an exponential rate. For example, in 2016, 68.3% of internet users were social media users; these figures are expected to grow [2]. Facebook, YouTube, Twitter, Instagram and Wikipedia are just a few of the most popular social media web applications. The amount of time people spend on these sites is also constantly increasing. For instance, Australians are now spending more than half a day per week (12.5 hours) on Facebook alone [3]. Hence, social media landscapes can be viewed as widespread communication platforms for consumption and for sharing a rich source of day to day information.

Social media plays an ever-growing significant role in an individual's social life by introducing enhanced features concerning their emotions and behaviour. For example, Facebook allows users to update their status or post information not only in text but using graphic emotion icons. By way of illustration – suppose an individual driving a newly released model of a car had recently updated his views on a social media account. His feelings and behaviours toward that product can now be analysed based on his comments and the use of any emotion icons. Such information can collectively form online knowledge and insights related to products,

---

\* Corresponding author; e-mail: <sup>1</sup>pratima.jain@student.curtin.edu.au, <sup>1</sup>ponnie.clark@curtin.edu.au, <sup>2</sup>Kit.Chan@curtin.edu.au

services and brands that are shared by disparate users [4]. Rathore, Ilavarasan, and Dwivedi, also consider social media as a major factor influencing users' behaviour in the form of opinions, perceptions, feedback, usage, intention, purchase habits, depth of analysis and the variety of shared information. In this context, collecting information from these interrelated multiple sources opens opportunities for more reliable and accurate knowledge which can further contribute to better business insights [5], [6]. For instance, having uniform information from multiple sources are likely to build consumer trust in a product. It can also help authenticate the information. Therefore, the fusion of information from social media can be beneficial for effective organisational analytics.

Furthermore, social media has considerably altered the traditional way of communication and interaction between businesses and consumers. These virtual communities are now penetrating the mass public, transitioning social media communication into the main form of communication. As a consequence, social media has enhanced the ability for industries to integrate customers into their business model [4]. For example, in new product development, the key factor of success of a new product is to capture the "voice of the consumers" [7]. Consequently, satisfying consumers' requirements is not only a "need" but also a "must" for every company. In this context, it is suggested that to cover all emotional aspects of a user, a product must exhibit three categories: (1) it must be useful (it must perform the designed tasks); (2) it must be usable (easy to use and interact with); and (3) it must be desirable (provides feelings of pleasure and creates attraction) [8]. With social networks, designers can use online consumer data to understand their requirements, affections and desirability. Hence, extracting and incorporating emotional, behavioural and demographical social media texts into the product design process may contributing to enhanced affective design.

Affective design involves the processes of identifying, measuring, analysing and understanding the relationship between the affective needs of the customer and the perceptual design attributes in the design domain [9]. The purpose of affective design is to satisfy the affective needs of users, by integrating their affective requisites in the design attributes of a new product [10]. This gives designers the ability to generate designs which appeal more to their target market. Affective design has been shown to excite customers' psychological feelings and can help improve customer satisfaction [11]. Conventional methods of affective design focus on predicting or determining the amount of affective quality, such as Neural Networks [12] and the Kansei Methodology [13], [14] which predicts consumer perceptions when the perceptual design elements of the products are given. However, perceptions are subjective; hence uncertainties are inevitable. In this context, the estimation of the amount of uncertainty in affective quality has been of limited focus in previous literature. Major works in this area include Chan et al. [10], who proposed an intelligent fuzzy regression technique to generate models for relating design variables to affective responses in which both non-linearity and fuzziness are considered. Chan and Engelke [15] presented a novel fuzzy regression method to predict affective quality and fuzziness in human assessments, for given objective features.

This paper discusses the possible ways to predict human evaluation of affective quality as well as the uncertainties in evaluating the affective quality by incorporating a fuzzy regression technique. Social media data is suggested to create Data Fusion for affective design. This paper presents a literature review of existing literature presented in four major streams; (i) social media, (ii) data fusion, (iii) affective design, and (iv) fuzzy regression. The rest of this paper is organised as follows. In section 2, we address the existing literature on social media for affective design. In section 3, we focus on the existing literature on data fusion with a requirement to deal with social media data and related challenges. In section 4, we outline the existing literature on affective design demand and various existing approaches. In section 5, we focus on the existing literature on the use of fuzzy regression techniques in calculating affective quality values. In section 6, we present the prospect framework and the paper ends with conclusion and future work in section 7.

## **2.Social media**

Social media is drawing significant attention from both application and research perspectives. Not only it is an integral part of information ecosystems, but also rapidly growing among users, consumers, corporations, governments and many other entities [1]. Breur [16] discusses social media as one of the four major streams of data analysis, which contains user generated data and sentiments. In addition, social media is considered a major factor influencing users' behaviour in the form of opinions, awareness, reviews, emotions, intention, purchasing habits, analysing and information sharing [4]. As a result, to leverage this, there arises a need to collect and analyse social media data to extract useful patterns and investigate current trends, user affective information etc.

Several works have been submitted for social media analytics techniques, as it plays a principal role in developing tools and frameworks to collect, analyse, summarize and visualise social media data. Zeng et al. [1]

discusses various challenges involved with social media analytics processes such as, retrieving massive data and related metadata, computing dynamic streams of rapidly increasing data, the integration process, user generated information mining etc. In addition, Zeng et al. explores social media intelligence as a source of more productive information, however this idea seems to be in the early stages of development. Similarly, Fan and Gordon [17] discuss the various scopes of social media analytics, by means of which useful patterns and users' affective information can be retrieved. In relation to this, a framework has been presented [18] for acute analysis of affective experiences to gain marketing insights. Grassi et al. [19] created a sentic web to manage affective information from social media by combining semantic analysis techniques and artificial intelligence methods, though the retrieval of dynamic emotions from social media presents as a limitation for this approach. In order to uncover these sentiments, Cambria [20] listed the major approaches for affective computing. These approaches did not clearly identify a common-sense knowledge base or reveal new affective knowledge in order to detect and perceive real emotions.

Another consideration is the co-creation of products through the use of social media networks, where consumers work online with company product designers to obtain user requirements [4]. It is also stated that, current patterns suggest social media could produce an additional \$940 billion in annual consumption, particularly in relation to the sale of electronics, hardware, software, and mobile technologies [4]. Thus, social media results in significant possibilities for product design and other commercial needs. The significance and applications of social media data has been covered extensively in previous studies. However, from a decision perspective, social media data still contains a level of uncertainty and is inherent with subjective opinion based information [1].

In view of the fact that social media data is essentially a collection of user generated data i.e. blogs, posts, comments, reviews and other forms of social media which is created by consumers [21], it is based on, or influenced by, personal feelings, tastes, or opinions. Hence, it is inherently ambiguous and uncertain. Taking this into account, a significant need arises to estimate the amount of uncertainty in social media data when obtaining user information.

### **3.Data Fusion**

These days, we are living in a digitized society where every single step is being recorded in some format, for which companies employ a number of social platforms in the market to stay in touch with their customers [16]. Social media data is generated from these wide range of internet applications and web portals. Example include, but are not limited to, Facebook, Twitter, LinkedIn and Instagram. These rapidly growing social sites allow companies to connect with users and has created a new generation of users who are enthusiastic about interacting, sharing, and collaborating, thereby forming a new mode of communication [22]. As a result, information dissemination through social media takes place in almost every area that includes business, education, tourism, day to day life and health among others. Hence, there arises a demand to collate and analyse data from these sources, to enhance the legitimacy and accuracy of the information.

Information Fusion ('IF'), involves the combination of information into a new set of information, aimed at reducing redundancy and uncertainty [23]. Along the same line, Data Fusion, which is a subset of Information Fusion, (or Information Integration), is the process of integrating multiple data sources to produce more consistent, accurate, and useful information than that which is provided by any individual data source [24]. It is applied in different fields where data is distributed and generated from diverse sources. Thus, to get a holistic view of customers, businesses ought to integrate information from multiple channels. In the field of literature related to data fusion, various methodologies have been proposed to accumulate heterogeneous information from a range of diverse sources. For instance, the crowdsourcing semantic big-data fusion approach has been used for heterogeneous media in the IoT environments, which provides higher-quality semantic fusion and more precise retrieval of information [25]. Breur discusses data fusion as one out of the four useful data analysis streams available to researchers [16]. Bello-Orgaz, Jung, and Camacho [22] summarise the challenges of data fusion which include: (1) obtaining more reliable methods for fusing the multiple features of multimedia objects for social media applications; and (2) studying the dynamics of individual and group behaviour, characterizing patterns of information diffusion, and identifying influential individuals within social networks.

Data fusion refers to resolving conflicts from different sources and identifying the truth that reflects the real world. Unlike schema mapping and- record linkage, data fusion is a relatively new field. Its motivation is exactly the veracity of data: the web has made it easy to publish and spread false information across multiple sources [26]. To overcome the challenges of data fusion, different techniques are being developed to suit real world applications. These intensive techniques are derived from different computing areas including artificial



intelligence, statistical estimation, pattern recognition, and so on [6]. However, given the very large heterogeneous dataset obtained from social media, one of the major challenges is to identify the valuable data and determining how to analyse it to develop useful knowledge [22]. Emerging big-data applications can be seen as a solution to the integration of the heterogeneous and dynamic stream of data from diverse social media channels.

#### **4. Affective Design and Kansei Engineering**

In today's competitive world, optimization of customer satisfaction is essential in new product development, in order to achieve optimal success [10]. To address customer satisfaction, Lee [27] developed a methodology to better understand user preferences based on perceived usability and perceived aesthetics. Results from this study show that before any actual use of a service or product, user preference was significantly affected by the aesthetics of the product rather than by usability factors. This is the reason why a lot of companies focus on the beauty of their products.

Affect, mood, and emotion are fundamental aspects of human beings and are found to influence, reflexes, perception, cognition, social judgment, and behaviour [28]. Fong [28] presents an approach for automatic generation of Personal Web Usage Ontology ('PWUO') of periodic access patterns from web usage logs. In this study, apart from efficiently providing users with periodic web personalisation patterns, Fong also discovered that emotional influence contributed positively to the results. Therefore, affective design plays an important role, in the development of designs which better appeal to their intended market. The sole purpose of affective design is to further satisfy user's affective needs rather than solely optimizing the functional needs for a product. This is done by integrating user's affective requisites within the design attributes of a new product [10]. Better affective design of a product increases that products' appeal to potential buyers and produces a more harmonious product [32].

Affective design draws its inspiration from Kansei engineering and attempts to relate subjective requirements to measurable product properties that can be tested and verified. Kansei Affective Engineering ('KE') [29] is defined as the technology of translating the consumer's Kansei into the product design domain. Nagamachi defined this process of performing Kansei Affective Engineering as: (1) grasp the consumer's Kansei in the specific product domain using psychological or psychophysiological measurements, (2) analyse the Kansei data by statistical, medical, or engineering methods in order to clarify the Kansei structure, (3) interpret the analysed data and transfer the data to the new product domain and (4) design a new Kansei product. KE methodology has successfully contributed to the development of many different products such as motor vehicles, coffee cans, beer cans, milk cartons and body cosmetics [9], [14], [30], [31].

Further, in relation to prioritising customer preferences, Chou [32] presents a Kansei evaluation approach based on the technique of computing with words ('CWW'), with the purpose of validating the classification of Kansei attributes using Kansei words, establishing priorities for customer preferences of product alternatives with respect to each attribute, and synthesising the priorities for the evaluated alternatives. Diego-Mas and Alcaide-Marzal [12] use a neural network based approach, to present a theoretical framework which enables single user responses to predict different product designs. Yadav et al. [33] utilises the application of the fuzzy Kano model into quality function deployment ('QFD') with the objective of analysing the customer's aesthetic feeling toward customer satisfaction. Jiang et al. [9] proposes and describes a methodology of simultaneous consideration of affective design and the determination of engineering specifications to determine design attribute settings and engineering requirement settings for a new product. An artificial intelligence (AI) based methodology [11], has been proposed for integrating the affective design, engineering, and marketing for defining design specifications, at an early product design stage. This study utilises the static market trend however, in the current technology climate, the world is evolving towards an era where online communities will define future products and services [4]. Hence, there arises a need to consume dynamic market in relation to affective design. In addition, inappropriate affective designs can only be determined by past affective information and data. Hence, there is a need for an approach that continuously updates user's affective quality information.

Much previous research has been conducted to estimate affective quality for better affective design. However, data relating to affective satisfaction is inherently vague or uncertain. The above-mentioned approaches are relatively unable to address this issue. In order to estimate the level of uncertainty or vagueness, recent research have shown that the fuzzy regression model is a more commonly used method for developing consumer preference models. The fuzzy regression model is explicit meaning that analytical information can be identified for use in new product development and developed models can address the fuzziness in consumer

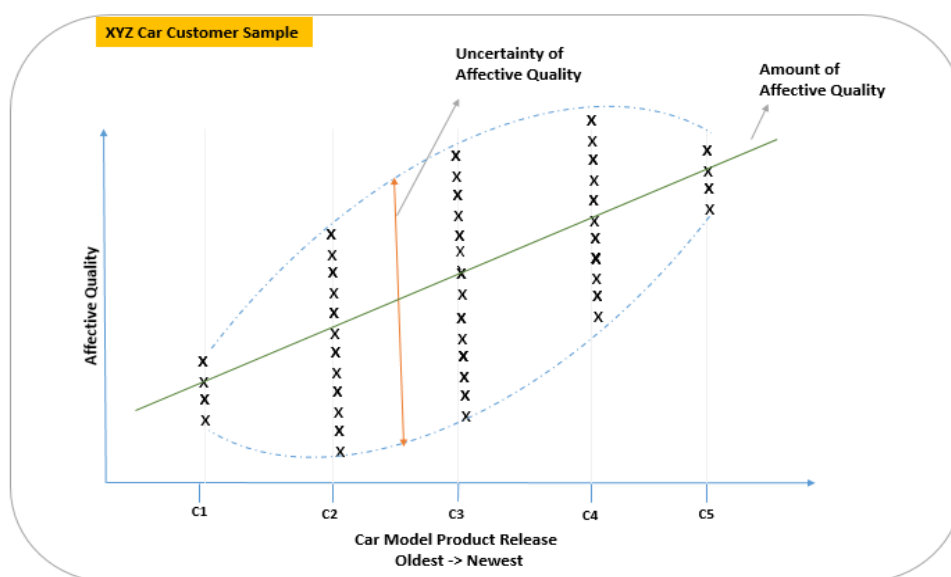
preferences [34]. Chan and Engelke [15] propose a novel fuzzy regression method to predict affective quality and estimate fuzziness (i.e. vagueness or uncertainty) in human assessments, when objective features are given. So far, studies have targeted fuzziness in observed survey data or static data yet there seems to be no research on estimating the effect of fuzziness on affective design datasets, which varies with time and can be captured online through the use of social media.

## 5. Fuzzy Regression

Previous studies have anticipated the significance of good affective design in new product development. In order to evaluate affective design, researchers have introduced different methodologies to measure the amount affective quality/aesthetic quality by either ‘surveying in order to obtain users’ subjective perceptions of object aesthetics’ or by ‘predicting affective qualities by means of objective features based on product design attributes’ [35]. Survey techniques were used for a number of studies. For example, Diego-Mas and Alcaide-Marzal [12] used a neural network-based mathematical model to present a theoretical framework which enables single user responses to predict different product designs. This is done using limited survey responses and thus offers less statistical power. Similarly, a large amount of research has been proposed using the Kansei engineering methodology [30], [13], [4] to better understand consumer perception and affective requirements. These studies are conducted using surveying techniques, that may contain too many subjective evaluation items in the questionnaires or survey questions, and there is a possibility for uncertainty to arise out of the subjective evaluations by participants. However, the uncertainty of interviewees in answering the survey data may not be analysed using traditional statistical methods. In addition, it is ambiguous to conduct a survey for every single design attribute of products. Surveying is time consuming and expensive, with limited access to the population of concern [35].

Another approach of predicting affective quality is based on the assumption that objective features of products are correlated with user’s affective quality perception [15]. As a result, empirical models can be built using objective features such as colours, product style, outlook, interfaces etc. in order to determine the affective quality of a product. Statistical regression techniques are generally used to estimate the correlation and significance of variables [15], [35], however uncertainty in subjective human evaluation cannot be taken in account. Since human emotions are uncertain, crisp values from statistical regression does not correspond effectively when assessing affective quality. To overcome this, the fuzzy regression methodology was developed, which evaluates the uncertainty in human perceptions.

A number of studies have used fuzzy regression techniques to estimate affective quality and uncertainty in human perception [15], [32], [10], [33]. In this context, products with acute affective quality are easy to evaluate. However, products with relatively moderate affective quality have a significant level of uncertainty.



**Figure 1** - Uncertainty of Affective Quality

Figure 1 illustrates the uncertainty of affective quality. For instance, suppose C1, C2, C3, C4, and C5 are different car models. C5 is the most recent model with the highest price and the highest affective design when compared to C4. C4 is the second most recent model with better affective quality than C3. C3 is the third most recent model with better affective quality than C2, and so on. Likewise, C1 is the basic model vehicle with the lowest price and the lowest affective design. As the affective quality evaluation is subjective, users may have more confidence in determining the affective quality of C5 and C1. Hence the evaluation of uncertainty is low. On the other hand, for intermediary models i.e. C2, C3, and C4, users have less confidence in evaluating the affective quality. Therefore, the uncertainty in evaluating the affective quality is higher for the average model vehicles, which have average affective qualities. Although Chan and Engelke [15] have developed a fuzzy regression method for predicting affective quality and uncertainty when evaluating affective quality, fuzzy regression coefficients are determined based on heuristic algorithms, which are time consuming and indeterminate. A more time-effective and determinate approach is essential to determine fuzzy regression coefficients. This approach will determine affective design of a product and uncertainty in evaluating affective quality which will help in attaining affective design of the car.

## 6. Prospect Framework

This section discusses a prospect framework to determine the perceptual uncertainty in affective design evaluation, while incorporating a social media big data framework and fuzzy regression techniques. As part of the social media framework, data fusion for affective design will be produced first by integrating two or more social media platforms. Customer segmentation will be achieved by clustering social big data on the basis of users' geographic location or age, to match different demands. Then, an algorithm based on the fuzzy regression model is suggested to detect the amount of uncertainty in social media affective data. This will contribute to the development of an affective design framework for a dynamic market.

The design and development involve the creation of the objects and model that employ data fusion by integrating affective design data from multiple social media channels and incorporating it with a fuzzy regression algorithm to evaluate the uncertainty in affective design evaluation. Since social media data is a part of big data, it adheres to the big data ('BD') value chain presented by Hu et al. [36] which covers the big data life cycle. This chain consists of four main phases: (1) data generation (or data extraction), (2) data acquisition, (3) data storage, and (4) data analysis. The prospect framework will pass through the lifecycle of big data to achieve the key objectives of the study. Figure 4 illustrates the detailed design structure which includes four phases of the big data life cycle to handle data and affective design evaluation.

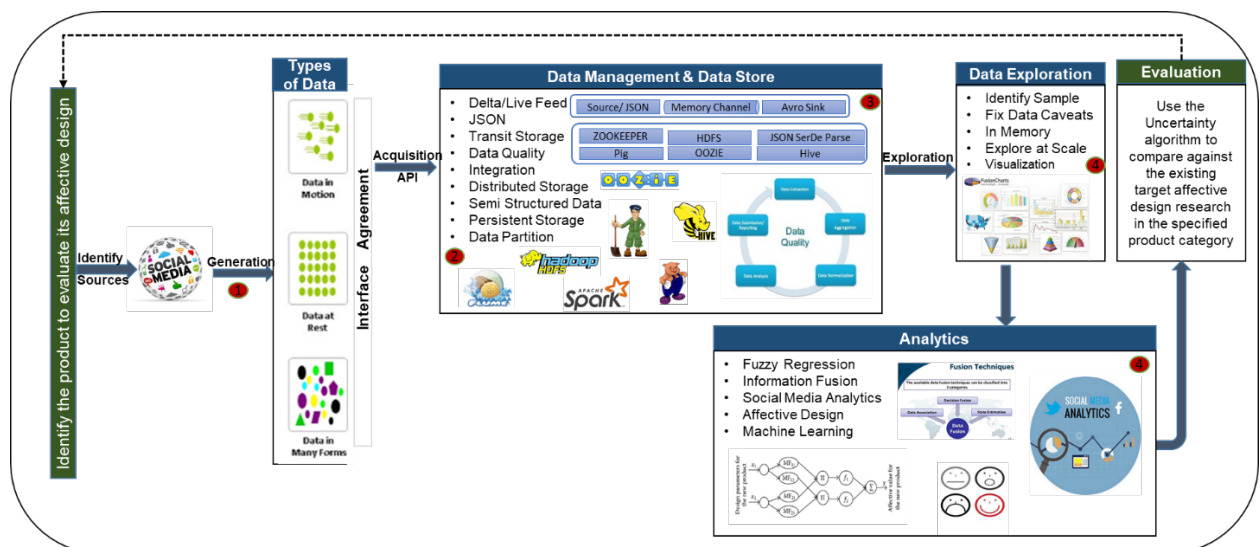


Figure 4 - Detailed Design Structure

- Data extraction

Every source (e.g. social media platforms) generates heterogeneous types of data which form a variety of dimensions of unstructured social media data. The scope of this research will focus on social media streams such as Facebook, Twitter, Instagram, and blogs.

- Data acquisition

In this stage of the study, using the interface agreement with social media (i.e. social big data) sources, the heterogeneous data is extracted in an unstructured/semi structured form, mainly in a JASON data format.

Accessing data requires a compatible Application Programming Interface ('API') which is a software program that has a defined way to access and retrieve data. Generally, social sites have their own compatible API's for connectivity. To capture a constant stream of data, a custom Cloudera Distribution Hadoop ('CDH') or an equivalent can be put together to build a data pipeline to ingest the data from the API to the Hadoop Distributed File System ('HDFS') [37].

Apache Flume is one of the data ingestion systems that consumes data delivered to it by an external web source. The concept on which it works involves processing the data through the following stages; Flume source; channel; sink; external repository. To elaborate, the external source sends data to Flume that is recognized by a Flume source; in this study, a JASON Flume flow agent or similar is required. When the Flume source receives the data, it will store the data in passive data storage channels and stay there until they are consumed by a Flume sink. The sink then removes the data and moves it into external repositories; this study uses the HDFS using a Flume HDFS sink [38].

- Data storage

A combination of HDFS, Hive and Oozie will be used to store, query and maintain the data partition. Once the Flume agent data loads the data into the HDFS (HDFS is NoSQL and hence difficult to query), it can be prepared for analysis by creating a table in the Hive using the Hive Serde interface to interpret the format. As the volume increases, it demands a need for partition which can be achieved by using Oozie [39].

SAS in its recent blog commented on the importance of the quality of big data. Data quality can be achieved within Hadoop. This is a critical aspect that requires consideration to ensure that data is well profiled and standardized [40].

- Data Exploration and Analytics

Hadoop will be used to interpret the unstructured and semi-structured data into a structured format which can be further analyzed using SQL or SQL equivalent queries. The next step is to understand the data, identify the sample for analysis, fix the data caveats and visualize the data for audit and visual interpretation. The following analytical tools are used; SAS Enterprise Guide, RStudio, SAS Visual Analytics, PostgreSQL, and Python. The ideal tool for this stage would be the SAS Visual Analytics tool, which works on memory concept.

An algorithm will be developed to evaluate the amount of uncertainty in this data by using fuzzy regression techniques. As part of fuzzy regression technique, independent variables will be taken as the design attributes of a car model i.e. body type, color, transmission etc to predict dependent variable i.e. magnitude of affective design and uncertainty in evaluating affective design. To deal with affective design attributes, keywords such as body configuration, color, automatic control will be selected from social media texts. This case study will segment customers to deal with different group interests. The tools in consideration include R and SAS Miner.

## 7. Conclusion and Future Work

In the current technology climate, the world is evolving towards an era where online communities will define future products and services [4]. This is the reason why, there arises a need to consume dynamic market trends in relation to affective design of products. Taking this into account, social media, majorly contributes to the big pool of online information, which is essentially a collection of user generated data i.e. blogs, posts, comments, reviews and other forms of media, created by consumers [21], also it is based on, or influenced by, personal feelings, tastes, or opinions. Hence, it is inherently ambiguous and uncertain. Thus, a significant need arises to estimate the amount of uncertainty in social media data when obtaining user information. In addition, with growing social media channels there arises a demand to collate and analyse data from these sources, to enhance the legitimacy and accuracy of the information.

Thus, an approach for determining the amount of perceptual uncertainty in human evaluation is required, while considering social media data analytics. The focus of this study is to develop a model using social media data and fuzzy regression techniques to estimate human uncertainty in evaluating the affective design of new products. To improve the effectiveness of the model, a case study will be performed, to evaluate

user's affective design preferences based on the research outcomes. Also using the suggested framework, customer segmentation based on age /ethnicity/geographic location can be generated in order to understand different group interests. Thus it can add value to product marketing as a future scope.

## References

- [1] D. Zeng, H. Chen, R. Lusch, and S. H. Li, "Social Media Analytics and Intelligence," *IEEE Intell. Syst.*, vol. 25, no. 6, pp. 13–16, Nov. 2010.
- [2] \* All products require an annual contract Prices do not include sales tax, "Number of social media users worldwide 2010-2020," Statista. [Online]. Available: <https://www.statista.com/statistics/278414/number-of-worldwide-social-network-users/>. [Accessed: 27-Jun-2017].
- [3] "Sensis Social Media Report." [Online]. Available: <https://www.sensis.com.au/about/our-reports/sensis-social-media-report>. [Accessed: 27-Jun-2017].
- [4] A. K. Rathore, P. V. Ilavarasan, and Y. K. Dwivedi, "Social media content and product co-creation: an emerging paradigm," *J. Enterp. Inf. Manag. Bradf.*, vol. 29, no. 1, pp. 7–18, 2016.
- [5] Z. Yan, J. Liu, L. T. Yang, and N. Chawla, "Big data fusion in Internet of Things," *Inf. Fusion*, vol. 40, pp. 32–33, Mar. 2018.
- [6] I. Yaqoob et al., "TEMPORARY REMOVAL: Information fusion in social big data: Foundations, state-of-the-art, applications, challenges, and future research directions," *Int. J. Inf. Manag.*, May 2016.
- [7] Y.-C. Lin and C.-C. Wei, "A hybrid consumer-oriented model for product affective design: An aspect of visual ergonomics," *Hum. Factors Ergon. Manuf. Serv. Ind.*, vol. 27, no. 1, pp. 17–29, Jan. 2017.
- [8] T. van Gorp and E. Adams, "Chapter 1 - Why Design for Emotion?," in *Design for Emotion*, Boston: Morgan Kaufmann, 2012, pp. 1–18.
- [9] H. Jiang, C. k. Kwong, Y. Liu, and W. h. Ip, "A methodology of integrating affective design with defining engineering specifications for product design," *Int. J. Prod. Res.*, vol. 53, no. 8, pp. 2472–2488, Apr. 2015.
- [10] K. Y. Chan, C. K. Kwong, T. S. Dillon, and K. Y. Fung, "An intelligent fuzzy regression approach for affective product design that captures nonlinearity and fuzziness," *J. Eng. Des.*, vol. 22, no. 8, pp. 523–542, Aug. 2011.
- [11] C. K. Kwong, H. Jiang, and X. G. Luo, "AI-based methodology of integrating affective design, engineering, and marketing for defining design specifications of new products," *Eng. Appl. Artif. Intell.*, vol. 47, pp. 49–60, Jan. 2016.
- [12] J. A. Diego-Mas and J. Alcaide-Marzal, "Single users' affective responses models for product form design," *Int. J. Ind. Ergon.*, vol. 53, pp. 102–114, May 2016.
- [13] Y. Cho and S. Kim, "A Study on Affective Design by Subjective-Objective Co-Approach," *World Congr. Eng.*, vol. 2, pp. 1120–1124, 2014.
- [14] C. Barnes and S. P. Lillford, "Decision support for the design of affective products," *J. Eng. Des.*, vol. 20, no. 5, pp. 477–492, Oct. 2009.
- [15] K. Y. Chan and U. Engelke, "Varying Spread Fuzzy Regression for Affective Quality Estimation," *IEEE Trans. Fuzzy Syst.*, vol. 25, no. 3, pp. 594–613, Jun. 2017.
- [16] T. Breur, "Data analysis across various media: Data fusion, direct marketing, clickstream data and social media," *J. Direct Data Digit. Mark. Pract. Basingstoke*, vol. 13, no. 2, pp. 95–105, Dec. 2011.
- [17] W. Fan and M. D. Gordon, "The Power of Social Media Analytics," *Commun ACM*, vol. 57, no. 6, pp. 74–81, Jun. 2014.
- [18] "Social media analytics empowering marketing insight- A framework for analyzing affective experiences from social media content (PDF Download Available)," ResearchGate. [Online]. Available: [https://www.researchgate.net/publication/304113102\\_Social\\_media\\_analytics\\_empowering\\_marketing\\_insight\\_A\\_framework\\_for\\_analyzing\\_affective\\_experiences\\_from\\_social\\_media\\_content](https://www.researchgate.net/publication/304113102_Social_media_analytics_empowering_marketing_insight_A_framework_for_analyzing_affective_experiences_from_social_media_content). [Accessed: 21-Jun-2017].
- [19] M. Grassi, E. Cambria, A. Hussain, and F. Piazza, "Sentic Web: A New Paradigm for Managing Social Media Affective Information," *Cogn. Comput.*, vol. 3, no. 3, pp. 480–489, Sep. 2011.
- [20] E. Cambria, "Affective Computing and Sentiment Analysis," *IEEE Intell. Syst.*, vol. 31, no. 2, pp. 102–107, Mar. 2016.
- [21] "User-generated content," Wikipedia. 15-Jun-2017.

- [22] G. Bello-Orgaz, J. J. Jung, and D. Camacho, "Social big data: Recent achievements and new challenges," *Inf. Fusion*, vol. 28, pp. 45–59, Mar. 2016.
- [23] "Information integration," Wikipedia. 26-Jul-2017.
- [24] "Data fusion," Wikipedia. 14-Jun-2017.
- [25] K. Guo, Y. Tang, and P. Zhang, "CSF: Crowdsourcing semantic fusion for heterogeneous media big data in the internet of things," *Inf. Fusion*, vol. 37, pp. 77–85, Sep. 2017.
- [26] X. L. Dong and D. Srivastava, "Big data integration," in 2013 IEEE 29th International Conference on Data Engineering (ICDE), 2013, pp. 1245–1248.
- [27] S. Lee, "The role of usability, aesthetics, and cognitive style on user preference for interactive applications," Ph.D., The Pennsylvania State University, United States -- Pennsylvania, 2010.
- [28] "Fong - generation of personalized ontology based on consumer emotion and behaviour analysis.pdf." [Online]. Available: [https://www.dropbox.com/scl/fo/inb14ccvz6vbk9pa6o47q/AADEK8kQ4p1ht8Djf2RzaQM7a?dl=0&preview=Fong++generation+of+personalized+ontology+based+on+consumer+emotion+and+behaviour+analysis.pdf&r=AAVJ7\\_wsTvJxmIadVmogEY4Lzmq9yWt7zZWFxQmS6znJ2d6sMDHVpSYFT\\_A\\_uye8c0nftjRYkRibxVLRkBuGDPIy\\_CwQ9I3p6Oourydm0I019FW5GtX9b2LfB4x8ZdbuckknOSWQ8VkzZoOaGOJrBa9SGercJFKIGg4IHpinDHuzQ&sm=1](https://www.dropbox.com/scl/fo/inb14ccvz6vbk9pa6o47q/AADEK8kQ4p1ht8Djf2RzaQM7a?dl=0&preview=Fong++generation+of+personalized+ontology+based+on+consumer+emotion+and+behaviour+analysis.pdf&r=AAVJ7_wsTvJxmIadVmogEY4Lzmq9yWt7zZWFxQmS6znJ2d6sMDHVpSYFT_A_uye8c0nftjRYkRibxVLRkBuGDPIy_CwQ9I3p6Oourydm0I019FW5GtX9b2LfB4x8ZdbuckknOSWQ8VkzZoOaGOJrBa9SGercJFKIGg4IHpinDHuzQ&sm=1). [Accessed: 05-Jul-2017].
- [29] M. Nagamachi, "Kansei/Affective Engineering and History of Kansei/Affective Engineering in the World," in *Kansei/Affective Engineering*, 2 vols., CRC Press, 2010, pp. 1–12.
- [30] "A Kansei Engineering Approach to Evaluate Consumer Perception on Social Media A Case Study of Giant Manufacturing Company.pdf." [Online]. Available: [https://www.dropbox.com/scl/fo/inb14ccvz6vbk9pa6o47q/AADEK8kQ4p1ht8Djf2RzaQM7a?dl=0&preview=A+Kansei+Engineering+Approach+to+Evaluate+Consumer+on+Social+Media+A+Case+Study+of+Giant+Manufacturing+Company.pdf&r=AAVJ7\\_wsTvJxmIadVmogEY4Lzmq9yWt7zZWFxQmS6znJ2d6sMDHVpSYFT\\_A\\_uye8c0nftjRYkRibxVLRkBuGDPIy\\_CwQ9I3p6Oourydm0I019FW5GtX9b2LfB4x8ZdbuckknOSWQ8VkzZoOaGOJrBa9SGercJFKIGg4IHpinDHuzQ&sm=1](https://www.dropbox.com/scl/fo/inb14ccvz6vbk9pa6o47q/AADEK8kQ4p1ht8Djf2RzaQM7a?dl=0&preview=A+Kansei+Engineering+Approach+to+Evaluate+Consumer+on+Social+Media+A+Case+Study+of+Giant+Manufacturing+Company.pdf&r=AAVJ7_wsTvJxmIadVmogEY4Lzmq9yWt7zZWFxQmS6znJ2d6sMDHVpSYFT_A_uye8c0nftjRYkRibxVLRkBuGDPIy_CwQ9I3p6Oourydm0I019FW5GtX9b2LfB4x8ZdbuckknOSWQ8VkzZoOaGOJrBa9SGercJFKIGg4IHpinDHuzQ&sm=1). [Accessed: 05-Jul-2017].
- [31] S. B. Sutono, S. H. Abdul-Rashid, H. Aoyama, and Z. Taha, "Fuzzy-based Taguchi method for multi-response optimization of product form design in Kansei engineering: a case study on car form design," *J. Adv. Mech. Des. Syst. Manuf.*, vol. 10, no. 9, pp. JAMDSM0108-JAMDSM0108, 2016.
- [32] J.-R. Chou, "A Kansei evaluation approach based on the technique of computing with words," *Adv. Eng. Inform.*, vol. 30, no. 1, pp. 1–15, Jan. 2016.
- [33] H. C. Yadav, R. Jain, S. Shukla, S. Avikal, and P. K. Mishra, "Prioritization of aesthetic attributes of car profile," *Int. J. Ind. Ergon.*, vol. 43, no. 4, pp. 296–303, Jul. 2013.
- [34] K. Y. Chan, H. K. Lam, T. S. Dillon, and S. H. Ling, "A Stepwise-Based Fuzzy Regression Procedure for Developing Customer Preference Models in New Product Development," *IEEE Trans. Fuzzy Syst.*, vol. 23, no. 5, pp. 1728–1745, Oct. 2015.
- [35] K. Y. Chan, H. K. Lam, C. K. F. Yiu, and T. S. Dillon, "A Flexible Fuzzy Regression Method for Addressing Nonlinear Uncertainty on Aesthetic Quality Assessments," *IEEE Trans. Syst. Man Cybern. Syst.*, vol. 47, no. 8, pp. 2363–2377, Aug. 2017.
- [36] H. Hu, Y. Wen, T. S. Chua, and X. Li, "Toward Scalable Systems for Big Data Analytics: A Technology Tutorial," *IEEE Access*, vol. 2, pp. 652–687, 2014.
- [37] © 2017 Cloudera, I. A. rights reserved A. Hadoop, associated open source project names are trademarks of the A. S. F. F. a complete list of trademarks, and C. Here, "CDH Overview." [Online]. Available: [https://www.cloudera.com/documentation/enterprise/5-9-x/topics/cdh\\_intro.html](https://www.cloudera.com/documentation/enterprise/5-9-x/topics/cdh_intro.html). [Accessed: 20-Jul-2017].
- [38] "Flume 1.7.0 User Guide — Apache Flume." [Online]. Available: <http://flume.apache.org/FlumeUserGuide.html>. [Accessed: 20-Jul-2017].
- [39] J. Natkins, "How-to: Analyze Twitter Data with Apache Hadoop," Cloudera Engineering Blog, 19-Sep-2012. [Online]. Available: <http://blog.cloudera.com/blog/2012/09/analyzing-twitter-data-with-hadoop/>. [Accessed: 20-Jul-2017].
- [40] "The growing importance of big data quality," The Data Roundtable. [Online]. Available: <http://blogs.sas.com/content/datamanagement/2016/11/21/growing-import-big-data-quality/>. [Accessed: 20-Jul-2017].

# Service Measurement Tool for Internet Service Provider

Somkiat Chormuan<sup>1,\*</sup> and Worachet Uttha<sup>1</sup>

<sup>1</sup>Department of Software Engineering, Faculty of Science and Technology,  
Nakhon Pathom Rajabhat University, Nakhon Pathom, 73000, Thailand

## Abstract

In this paper, we propose a new service measurement tool that ISPs can be used to assure their clients of the quality of service in different areas. Our tool uses PHP API of RouterOS to control MikroTik devices. The RouterOS allows us to verify network performance and control the network's service measurement both in manual mode and scheduled mode. In the latter mode, we can specify the data size, the network we want to measure or the interval to repeat the same operation then save the result to the database, our tool will send the notification to the ISP via SMS. We also use the Fullcalendar2 framework to visualize the result in a calendar depending on the selected date. The result is shown in form of the bandwidth graph, average upload-download speed and percentage of measurable data that obtained from Canvas.js. The result presents the connection map of devices made from Google Map. Our tool is divided into 3 parts: 1) MikroTik router management, 2) service measurement and 3) user management that we separate users into 3 levels: 1) Maintenance officer, 2) District chief and 3) central authorities.

The result indicates that 1) users at every level can use our tool over the internet 2) the district chief can manage users and verify devices' performance in every area 3) maintenance officer can install and register devices via our tool 4) the management and measurement the performance of the network in each area are centralized and controlled by central authorities. Our tool has the flexibility to measure the performance of the network and the results are reliable that we can use to improve the service and more than that we can apply our tool to the various organizations for a low-cost software package.

**Keywords:** Service Measurement, MikroTik, RouterOS, Network Probe, Software API

## 1. Introduction

The internet service provider (ISP) is the company we pay a fee to get the access to the internet. All internet connected devices send a service request through their ISP to access to servers, those servers themselves have to send a response to the request via their own ISP. To maintain the stability and availability of services, the ISPs have to measure frequently the performance of their service and they can use that information to improve the quality of service and manage their system. There are several criteria for measuring the network such as performance, reliability and security[1]. The main objective of service management is 1) to monitor and detect anomalies in the system 2) to collect service's statistics that can be used to upgrade management and organization of the system. In general, ISP uses the Active Monitoring to collect all statistics and use them to analyze and organize the network management, for example, the Multi Router Traffic Grapher (MRTG)[2] is used on large networks. It is required both software and hardware with high capabilities, that means we need to pay at a high cost to measure the performance of the whole system, in order to increase service quality.

The use of technology in the measurement and testing of telecommunications systems, the administrators must focus on the assurance of services qualities as follows:

- 1) We must measure and test the telecommunication system by verifying different performance aspects such as availability of the service, network congestion and time of errors detection, etc.
- 2) The measurement and testing of telecommunications systems should not perturb the performance of the system.
- 3) The maintenance of telecommunication devices must be always in place in order to make sure that the service will always available.

Moreover, the management of complex and numerous networks drives the many difficulties to the manager to verify the operation of their devices, that why we need a tool that helps us to understand the problems and how to solve them correctly and quickly. Since the system is in the failure state for a long time

---

\* Corresponding author; e-mail: tko@webmail.npru.ac.th

that can make a significant impact on their business. So that, the main objective of our research is to study and develop a service measurement tool for telecommunication networks using MikroTik devices. Plus, reduce the testing cost and add expressivity of service measurement tool by adding users and devices management.

In this research, we propose a new system that can measure the service performance based on the standard RFC2554[3] for the testing of Ethernet Service in Telecom Networks that the management is the Centralized Network Monitoring[4] using MikroTik[5] in each area in order to verify and measure the operation of the network. Our approach can reduce the cost of hardware that needs for the service measurement, and the mobility of measurement devices is easier. We can use our tool to verify the failure of the main communication devices without the interruption of service. Further details are presented in the following sections. Section 2 explains materials and methods used in this research, focusing on MikroTik devices and RouterOS, mechanism and architecture of our tool and the development of the system. Section 3 presents results and discussion on our work and Section 4 draw conclusions and suggestion for future works.

## 2. Materials and methods

### 2.1 State of the art

The monitoring of Quality of Service (QoS) in telecommunication infrastructure can be done via various methods such as 1) Using software agent to track and collect the information we need sometimes it can work with the Artificial Intelligence. The software Agent approach has a constraint that both monitoring software and the operating system must be compatible and we need to verify if the agent still active. The well-known software is ManageEngine OpManager, PRTG Network Monitor, Site24x7, SysAid and Spiceworks IT Desktop. 2) Sending a small program to the target device and waiting for the occurred anomalies signals for example, when the system is down. The program is customized to specific devices and specific proposes.

In our research, we use the second approach that named Action Packed that combines detailed network topology, device, and flow visualizations with direct interactive monitoring and configuration of QoS, NetFlow, LAN, Routing, IP SLA, Medianet and AVC features.

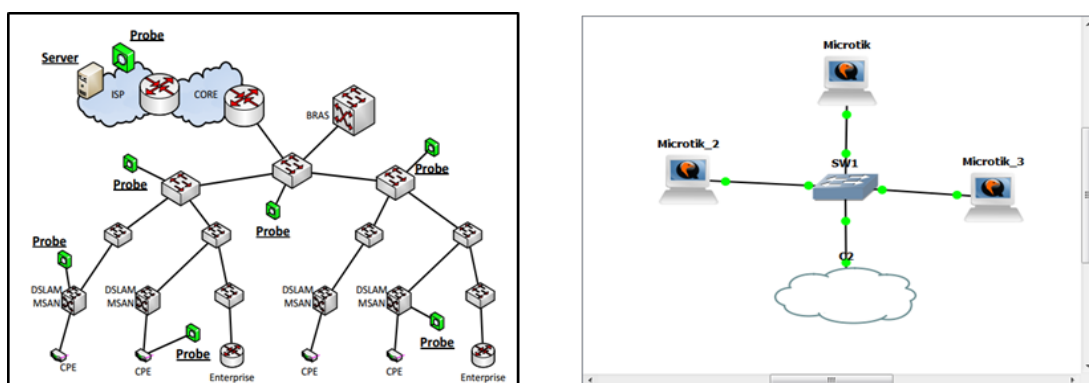
### 2.2 MikroTik and RouterOS

MikroTik[5] is a Latvian company which was founded in 1996 to develop router and wireless ISP systems. It provides hardware and software for internet connectivity from around the world. The well-known MikroTik's software, RouterOS, is a system that provides extensive stability, controls, and flexibility for all kinds of data interfaces and routing.

We can control MikroTik router using RouterOS via PHP API [6,7] named PHP\_PEAR that we must install it on the server to use PEAR2\_Net\_RouterOS which is a package for sending a command via IP Address of the devices in the network. We can download the package from [http://pear2.github.io/Net\\_RouterOS/](http://pear2.github.io/Net_RouterOS/) then enable API service for the devices.

### 2.3 System overview

We use GNS3[8] along with RouterOS to simulate the operation of the system that uses MikroTik devices before the application in the real environment as shown in figure 1.

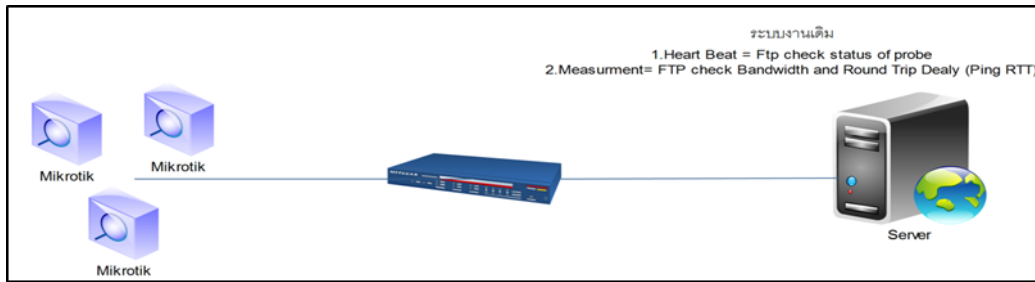


**Figure 1** Simulation of MikroTik devices' connections

In the classic service measurement system[9] to measure a service performance, we need to write a script then send it to the device that we want to measure via FTP protocol then waiting for the result file sent to the server to display the result in the system as shown in figure 2. When we want to edit the script, we need to

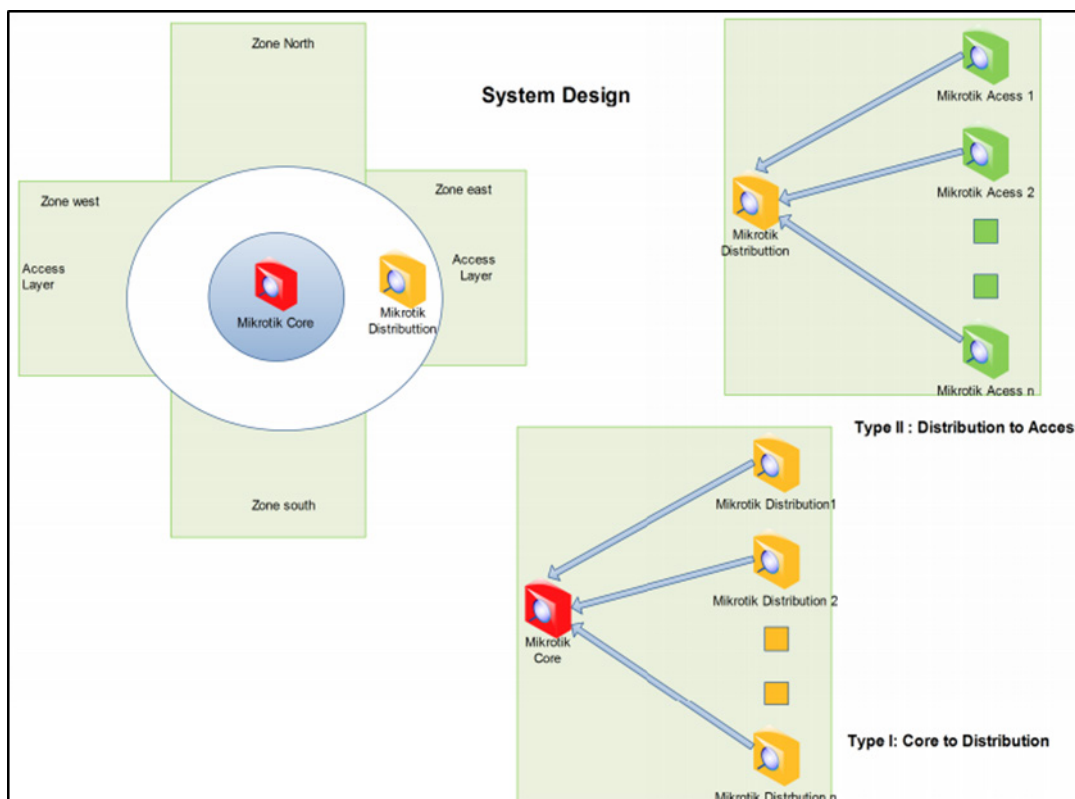


resend a new script to the target device that can drive us to the connection problem and we need more time to operate.



**Figure 2** Classic service measurement system

In our method, the system is developed based on distributed approach. We distribute the control from central server to the core unit of each area (figure 3) to share the workload with the server. Moreover, we can easily control and manage devices in each sub-area.



**Figure 3** New service measurement System Overview

**2.4 System’s workflow**

The operation flow of our system (figure 4) can be divided into 3 sections as follow:

- 1) User Management: we separate users into 3 levels, each has different right to control devices:
  - a. Maintenance officer can do a Probe’s test within his zone
  - b. District chief can do a Probe’s test across different zones
  - c. Central authorities can do which Maintenance officer and District chief can do
- 2) Probe Management: we can register every device and fix its IP Address to check its performance later, we can verify devices’ status and set device’s working time and point device’s location on Google Map.

3) Performance measurement: we can measure various aspects such as Ping, Bandwidth and show the result in form of graph and we can set measurement timer and the interval of auto-testing.

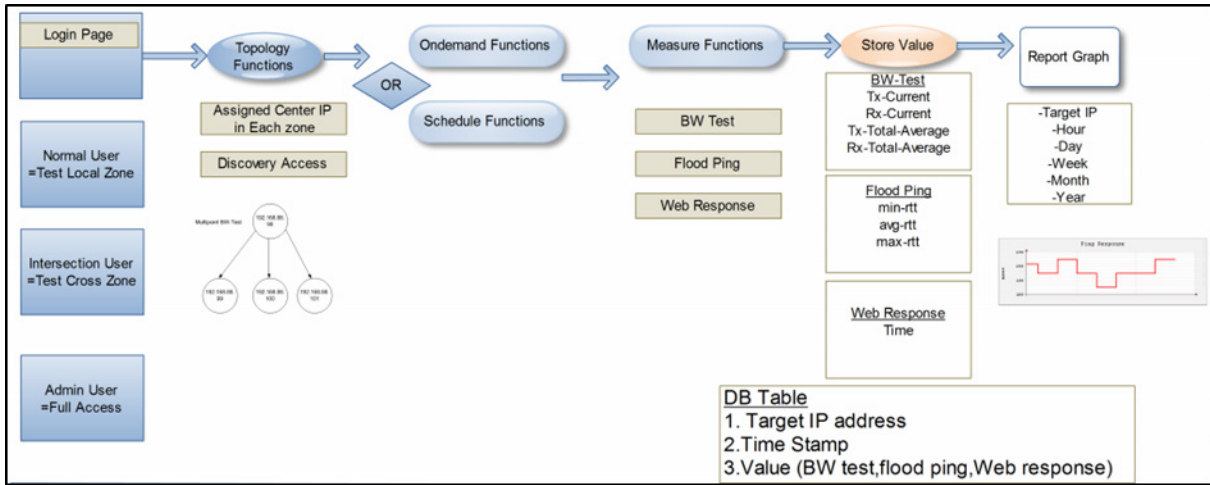


Figure 4 System's workflow

### 2.5 System development

```

1  <?php
2  $sla_no=$_POST["sla_no"];
3  //$sla_no="sla01";
4  $comm=sprintf("php canvas_json_db_sh.php %s",$sla_no);
5  passthru($comm);
6  ?>
    
```

Figure 5 Remote Code Execution

```

10  $probe_ip=mysql_result($rs1,0,2);
11  $probe_user=mysql_result($rs1,0,3);
12  $probe_pw=mysql_result($rs1,0,4);
13  $client = new RouterOS\Client($probe_ip, $probe_user,$probe_pw);
14  $responses= $client->sendSync(new RouterOS\Request('/tool/netwatch/print'));
15  $pl=count($responses)-1;
16  $sql4="select * from probe";
17  $rs4=mysql_query($sql4,$netview) or die ("x");
18  $p2=mysql_num_rows($rs4);
19  $sql2="Select probe.probe_ip from probe left outer join probe_ch_status on probe.probe_ip =
    probe_ch_status.status_ip where probe_ch_status.status_ip is NULL";
20  $rs2=mysql_query($sql2,$netview) or die ("x");
21  while($row = mysql_fetch_array($rs2)){
22      $com=sprintf('/tool/netwatch/add host="%s"', $row["probe_ip"]);
23      $client->sendSync(new RouterOS\Request($com));
24  }
25  $responses2= $client->sendSync(new RouterOS\Request('/tool/netwatch/print'));
26  foreach ($responses2->getAllOfType(RouterOS\Response::TYPE_DATA) as $response) {
    //...
    }
    
```

Figure 6 PHP API for RouterOS

Figure 5 and 6 are code fragments of our system that shows how to use PHP\_API to communicate with RouterOS installed in MikroTik devices. To communicate with RouterOS, we first create an object Client to send a command to the target device via its IP Address using function `sendSync()` with the syntax **“new RouterOS\Request('command that we want to send for example: /tool/netwatch/print')”**. The waiting for the response. Then, the application will send the object of measurement in order to be stored in the database.

We can use function `time_sleep_until()` (figure 7) to make the system repeat the service measurement in specific interval then save the test in system's database in instance test mode or timer test mode and we can use the function `curl()` to send testing's notification via an SMS.

```

15 if($t=="Now"){
16     $t="+5 seconds";
17 }
18 //repeat
19 while($rep!="")
20 {
21     $timestamp = strtotime($t);
22     $time_go=date('Y-m-d H:i',$timestamp+($rep*60));
23     if(time_sleep_until($timestamp)){
24         $sql2="UPDATE `netview`.`service_schedule_logs` SET `sv_time_start` = '$time_go'
WHERE `service_schedule_logs`.`sv_sla` = '$sla'";
25         $rs2=mysql_query($sql2,$netview) or die ("x");
26         $comm=sprintf("php canvas_json_db_sh.php %s",$sla);
27         passthru($comm);
28         $sql3="select * from service_schedule_logs where sv_sla='$sla'";
29         $rs3=mysql_query($sql3,$netview) or die ("x");
30         $t=mysql_result($rs3,0,7);
31         $sla=mysql_result($rs3,0,2);
32         $rep=mysql_result($rs3,0,11);
33     }
34 }
35 }
36 else{
37     if($t=="Now"){
38         $t="+5 seconds";
39     }
40     //in time
41     $timestamp = strtotime($t);
42     if(time_sleep_until($timestamp)){
43         $comm=sprintf("php canvas_json_db_sh.php %s",$sla);
44         passthru($comm);
45     }
46 }
47 $sql3="select * from sms_message where sms_type ='2'";
48 $rs3=mysql_query($sql3,$netview) or die (mysql_error());
49 $sms_into=mysql_result($rs3,0,1);
50
51 $sql4="select * from user where `user_login` = '$user_send'";
52 $rs4=mysql_query($sql4,$netview) or die (mysql_error());
53 $user_tel=mysql_result($rs4,0,7);
54 $sms=sprintf("[netview]%s[%s]successful",$sms_into,$sla);
55 //send sms
56 if($user_tel!="" and $sms!="")
57 {
58     $smsdata=sprintf(
59 "http://203.113.6.37/user=totpayphone&password=pathumthani&onenumber=%s&sender=0893005740
&text=%s",$user_tel,$sms);
60     $ch = curl_init();
61     curl_setopt($ch, CURLOPT_URL, $smsdata);
62     //return the transfer as a string
63     curl_setopt($ch, CURLOPT_RETURNTRANSFER, 1);
64     // $output contains the output string
65     $output = curl_exec($ch);
66     // close curl resource to free up system resources
67     curl_close($ch);
68 }
?>

```

Figure 7 Service Measurement Control and testing's notification

### 3. Results and discussion

#### 3.1 Dashboard

The dashboard (figure 8) is design based on Kaplan & Norton's concept[7] that allows the user to explore and follow the result of service measurement. Our dashboard is divided into 5 sections:

- 1) Area Management: show Probe devices in different areas and their information such as IP Address, name and location
- 2) User Management: manage users in system, show list of all users, specify their access right and modify users' attributes
- 3) Probe Management: manage Probe devices, show list of devices that user has a right to access and specific information about devices

- 4) Service Measurement: measure the performance of service, and test network performance
- 5) Report: export the testing report into the calendar format.

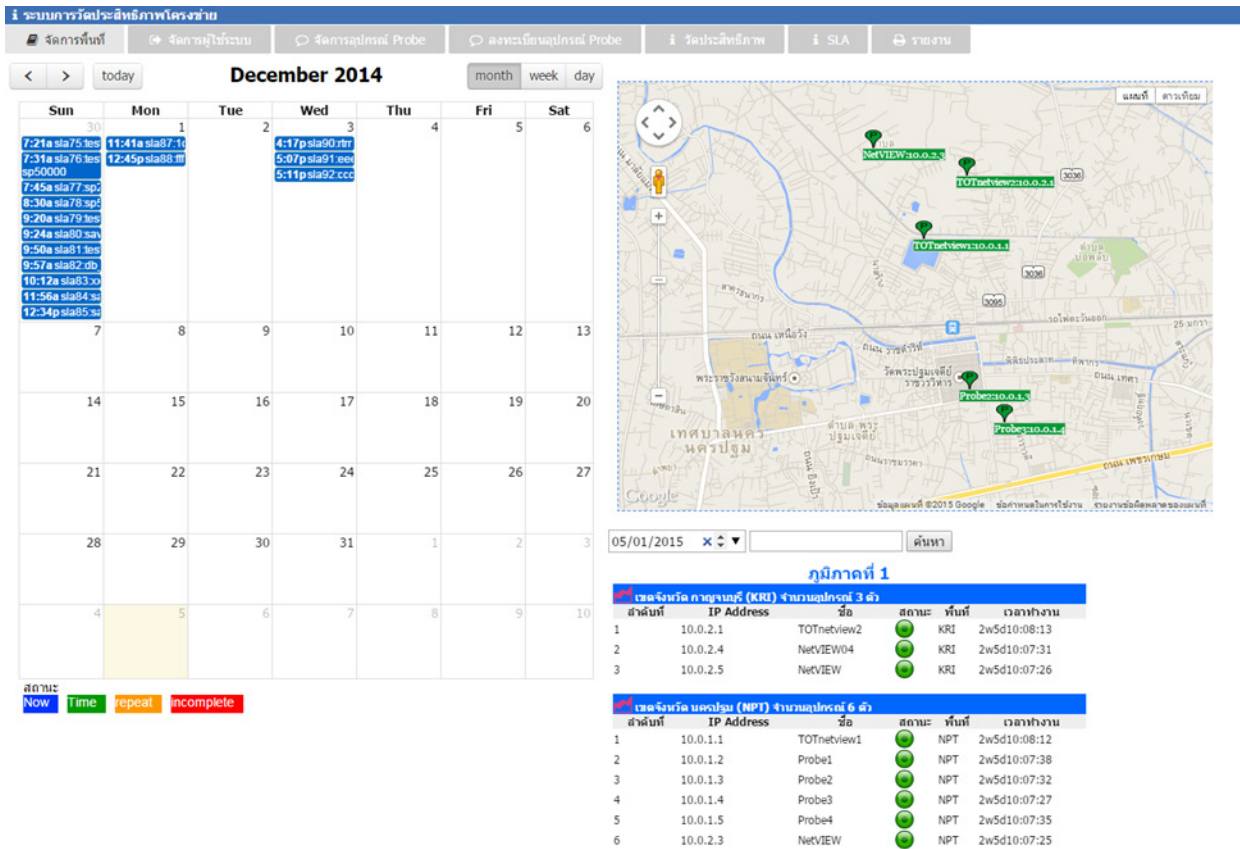


Figure 8 System Dashboard

### 3.2 Service measurement result

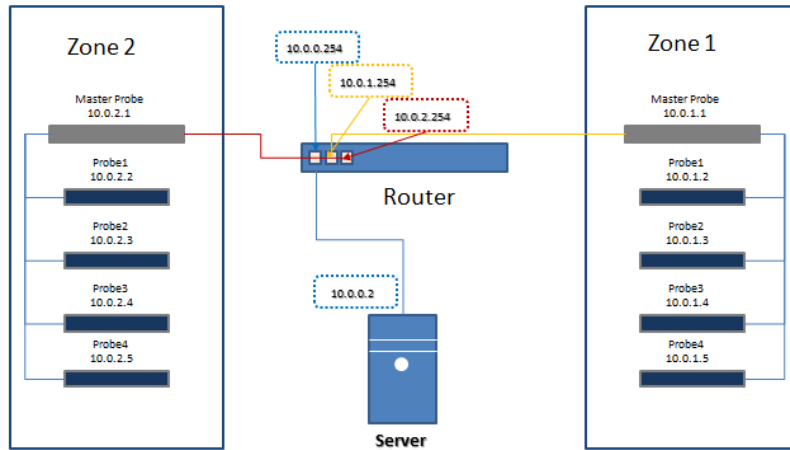
A Service Level Agreement (SLA)[10,11] is a contract between Service Providers and Customers that specifies what services the Service Provider will furnish, what transmission rate the Service Provider guarantee and what penalties the Service Provider will pay if he cannot meet the committed goals. The SLA will drive Service Provider to contribute to their customer's trust in terms of managed reliability and monitoring capabilities. To assure the availability and quality of their service, the Service Provider should verify in various aspect as shown in table 1.

Table 1 Service Measurement Testing aspects

Testing aspects	Result		Remark
	Correct	Incorrect	
Measurement in the same area	X		Depend on area
Measurement across areas	X		Depend on access right
Measurement with specific bandwidth	X		0.5-5 Mbps
Measurement with scheduled test	X		1-30 mins
Continuous measurement in different period	X		Starting from 1 mins
Repeat the measurement	X		every 5 mins
Measurement with many devices in the same time	X		More than 1 device

From Table 1, we implement our system as shown Figure 9 we have tested many times from 3 users in different areas with different access right as follows:

- 1) tko user at Nakhon Pathom (NPT) area as a maintenance officer
- 2) aue user at Kanchanaburi (KRI) area as a district chief
- 3) ana user at Bangkok (BKK) area as a central authority



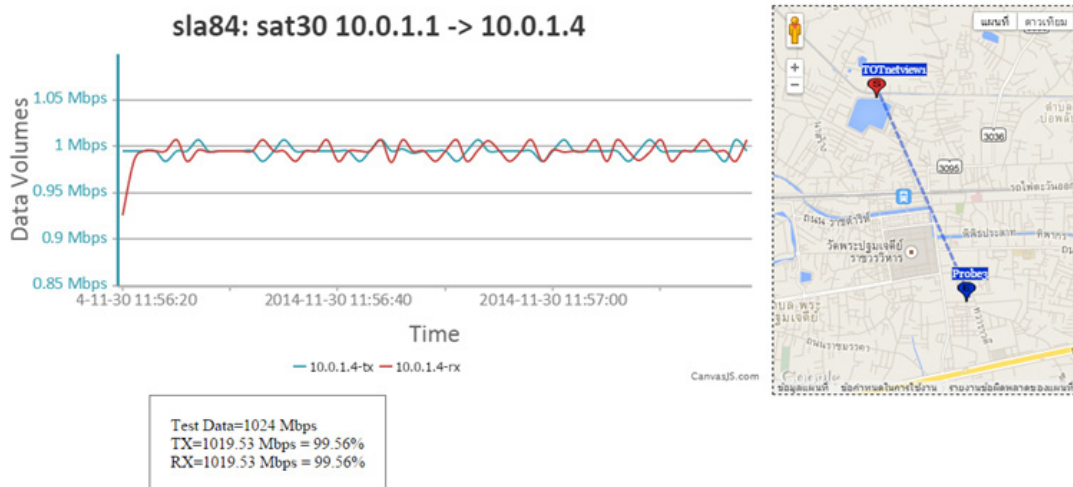
**Figure 9** Overview of the network

The service measurement result is presented in the Table 1 that can show the correctness of different testing aspects, as shown in Figure 9. The result is presented in the Table 2 that show the service performance with different parameters.

**Table 2** Service Measurement Result with specific bandwidth

Order	Source	Destination	Time	User	Area	Bandwidth	TX (Kbps)	RX (Kbps)
1	10.0.2.3	10.0.2.5,10.0.1.1	1 min	anan	BKK	1 Mbps	1019.53	1019.53
2	10.0.1.1	10.0.2.5	1 min	anan	BKK	1 Mbps	1019.33	1019.53
3	10.0.2.3	10.0.1.4	1 min	anan	BKK	1 Mbps	1019.33	1019.33
4	10.0.2.3	10.0.2.5	1 min	anan	BKK	1 Mbps	1019.73	1019.73
5	10.0.1.1	10.0.1.3	1 min	aue	KRI	5 Mbps	5110.99	5110.39
6	10.0.1.1	10.0.1.4	1 min	aue	KRI	6 Mbps	6142.04	6141.83
7	<b>10.0.1.1</b>	<b>10.0.1.4</b>	<b>1 min</b>	<b>aue</b>	<b>KRI</b>	<b>1 Mbps</b>	<b>1019.53</b>	<b>1019.53</b>
8	10.0.1.1	10.0.1.4,10.0.2.3	1 min	tko	NPT	1 Mbps	1019.33	1019.53
9	10.0.2.3	10.0.1.4	1 min	tko	NPT	2.5 Mbps	2554.48	2554.87

Figure 10 is the detail of the order 7 in Table 2. The source is 10.0.1.1 and the destination is 10.0.1.4. The output is shown in graph and in map location. In one minute of testing and bandwidth is 1 Mbps, the average value of Transmit Rate (Tx) is 1019.53 Kbps or 99.56%. The average value of Receive Rate (Rx) is 1019.53 Kbps or 99.56%.



**Figure 10** Measurement result Service Level Agreement

In order to evaluate tool, we have TOT Public Company Limited. TOT is a ISP, a Thai state-owned telecommunications company. TOT has applied our tool with TOT Netview within one year, the result has been shown that our tool can save the cost 133,261 baht per set of Probe and 13,000,000 baht for the server needed for their own classic monitoring[9].

#### 4. Conclusions & Future works

In this research, we develop a new service measurement tool for telecommunication networks using MikroTik devices and RouterOS and control these devices via PHP API that allows the user to manage the system, user, networks devices and allow users to measure the performance of the system.

In the future works, we can extend the expressivity of our tool by distributing the control to local control unit instead of using centralized control unit to share the workload and diffuse the risk of script working failures. We will try to use every functionality that came with the network device to improve the management of the system.

#### References

- [1] Tiankantade K. Measurement, Analysis, Evaluation of universal primary education. Bangkok: Butterfly publisher, OPAC; 1993 [cited 2017 Oct 30]. Available from: [http://library.montfort.ac.th/mylib/bookdetail.php?book\\_id=5881](http://library.montfort.ac.th/mylib/bookdetail.php?book_id=5881)
- [2] MRTG - The Multi Router Traffic Grapher. MRTG. [cited 2017 Oct 30]. Available from: <http://www.mrtg.org/>
- [3] Burgess N. Rfc 2544 testing of ethernet services in telecom networks. White Pap. 2004;
- [4] Boonchieng E. MVT Communication Public Company Limited. 2011 [cited 2017 Oct 30]. Available from: <http://www.mvt.co.th/viewnews.php?nid=420>
- [5] MikroTik. [cited 2017 Oct 30]. Available from: <https://mikrotik.com/>
- [6] Hasnain S. Design, Implementation and Monitoring of an ISP's Network Scenario [Thesis]. East West University; 2015 [cited 2017 Oct 31]. Available from: <http://dspace.ewubd.edu/handle/123456789/1788>
- [7] Stoitsov G, Rangelov V. One implementation of API interface for RouterOS. TEM J. 2014;3(2).
- [8] Welsh RC. GNS3 Network Simulation Guide. Packt Publishing; 2013. 154 p.
- [9] TOT Public Company Limited (Thailand). TOT-netview. Network Performance Measurement Systems. (TOT-netview). [cited 2017 Oct 30]. Available from: [http://www.sepo.go.th/tiny\\_mce/plugins/filemanager/thumbs/soe-2556.pdf](http://www.sepo.go.th/tiny_mce/plugins/filemanager/thumbs/soe-2556.pdf)
- [10] Kaplan RS, Norton DP. The Strategy-Focused Organization: How Balanced Scorecard Companies Thrive in the New Business Environment. 1 edition. Boston, Mass: Harvard Business Review Press; 2000. 416 p.
- [11] Iwata A, Fujita N. A hierarchical multilayer QoS routing system with dynamic SLA management. IEEE J Sel Areas Commun. 2000 Dec;18(12):2603-16.
- [12] Marilly E, Martinot O, Betgé-Brezetz S, Delègue G. Requirements for service level agreement management. In: IP Operations and Management, 2002 IEEE Workshop on. IEEE; 2002. p. 57-62.

# Semantic Web-based Approach for Economic Performance Indicators Based on Global Reporting Initiative (GRI) G4

Ilham S.Y. Yaldo<sup>1,\*</sup> and Udsanee Pakdeetrakulwong<sup>2</sup>

<sup>1</sup>Accounting Tech. Dept., Institute of Administration /Al-Rusafa, Middle Technical University, Iraq

<sup>2</sup>Software Engineering Department, Nakhon Pathom Rajabhat University, Thailand

## Abstract

The aim of this research is to fill the gap by developing ontology for Economic Performance Indicators based on the latest guidelines (GRI G4). The chief research question is: What is the best approach to developing an Ontological Model for the knowledge domain Economic Performance Indicators? The main objective of this research is to develop ontology for Economic Performance Indicators based on GRI G4. The methodology used in this research is a merger of several existing methodologies. The methodology adopted as a result of this applied research includes four phases: specification, conceptualization, formalization, and implementation. A requirement specification for Economic Performance Indicators ontology was created by identifying the intended scope and purpose of scenarios for each of the phases of ontology. The classes, properties, and relationships for Economic Performance Indicators based on GRI G4 were also identified. A conceptual model was formalized using UML. The implemented ontology is based on OWL language. And protégé tool to encode competency questions and subsequent SPARQL Queries. The resulting ontology was tested using instances data collected for four Australian companies listed on the Australian Securities Exchange (ASX), namely: Origin Energy Limited (ORG), Amcor Limited (AMC), Transurban Group (TCL), and BHP Billiton (BHP).

As mentioned, the ontology of content was evaluated to meet the criteria of completeness, consistency, and conciseness, and SPARQL Queries' answers were obtained establishing its utility and rationality. As a consequence, the developed ontology for Economic Performance Indicators was validated. There is clear evidence that few Australian companies have adopted either GRI or other initiatives and standards for reporting and that this position needs to be addressed. The ontology as proposed in this research could be applied to correct this concern. The four companies used to test the ontology are from different industries and sub-industry classifications and, as a result, the findings are not generalizable outside of these industries. However, the main finding of this research demonstrates that the majority of instances contained within the GRI4 Guidelines was validated suggesting that the ontology framework is effective as a standardized form of reporting.

**Keywords:** Economic Performance Indicators, GRI Sustainability Reporting Guidelines G4, Ontology, Stakeholders

## 1. Introduction

Reporting by corporations on economic, environmental and social dimensions, referred to as "Sustainability", is seen as a step towards a sustainable global economy that combines long-term profitability with social justice and environmental protection [1]. The history of sustainability reporting began at the beginning of the 20<sup>th</sup> century with employee reporting, social reporting, environmental reporting, triple bottom line reporting and sustainability reporting [2]. Some authors contend that there is currently no suitable definition for sustainability reporting [3]. Kolk and Herzig and Schaltegger claim that since the mid-1990s the number of companies reporting on sustainability has increased substantially and new forms of corporate sustainability reporting are being developed, resulting in reporting contents and formats being subject to change from year to year [4].

Several theoretical approaches that explain the motivation for sustainability reporting include: accountability theory, legitimacy theory, and political economy and stakeholder theory [5] [2]. There are several national and international bodies that promote sustainability reporting and provide guidance; these include: Global Reporting Initiative (GRI), the International Standards Organization (ISO), the World Business Council for Sustainable Development (WBCSD), AccountAbility, and the Sustainability Integrated Guidelines for Management (SIGMA) Project [2]. Christofi, Christofi, and Sisaye argued that it was important to have standardized sustainability reporting by corporations [6]. The GRI guidelines are generally accepted as "best practice" reporting and are widely used by organizations around the world as the basis for their environmental

---

\* Corresponding author; e-mail: ilhamsy\_ilhamsy@yahoo.com

and social reporting [5]. The guidelines provide guidance on how to write and what to write and present principles that guide report content and report quality [7]. An ontology methodology plays an important role in the design of information systems [8]. It provides a formal specification for the concepts within a domain and the relationship between those concepts [9]. There are many existing definitions of ontology, arguments about what the definition of ontology is or ought to be [10], and debates on what is the best definition [11]. Studer, Benjamins, and Fensel define ontology as a “formal, explicit specification of a shared conceptualisation” [12]. This is one of the most comprehensive definitions from those available in the literature [13]. A new information system for sustainability reporting is required as it has become an important source of monetary and non-monetary, quantitative and qualitative information [14]. There are several studies that develop ontologies in different aspects of accounting but little ontological research exists within the accounting domain. For example, Chou, Vassar, and Lin developed an ontology concept model for profit and loss accounts and implemented it for Microsoft’s NET software [15]. Teller established ontology of accounting notions to represent the entire domain knowledge based on International Financial Reporting Standards (IFRS)[16]. Chou and Chi proposed an ontological model comprising Event, Principle and Account (EPA) for accounting principles [17]. Smeureanu et al. developed ontology for Corporate Social Responsibility based on the guidelines proposed by the ‘ISO 26000 Standard for Social Responsibility’ [18]. Weigand and Elsas introduced a model-based auditing approach as a design artefact that includes a corresponding business modelling language [19]. Weigand, Johannesson, and Bergholtz introduced a service accounting model based on a formal ontology approach and propose some adaptations to the Resource-Event Agent (REA) model [20]. From the literature review, ontology for economic performance indicators based on GRI G4 does not exist. Thus, the aim of this research is to fill the gap by developing an ontology for economic performance indicators based on GRI G4. The Economic performance indicators focus on the financial organization’s performance and impacts on the stakeholders by clarifying the flow of capital among them; it does not focus on the financial status of the organization. In addition, they focus on economic systems at local, national, and global levels [21].

In this research, the ontologies for Economic Performance Indicators based on the Global Reporting Initiative guidelines (GRI G4) are presented. This paper is structured in the following manner. In Section 2, Research objective is described and then followed by Materials and methods in Section 3. In Section 4, Results are presented. In Section 5, ontology evaluation is described and followed by discussion in Section 6. Section 7 is a conclusion and future work.

## 2. Research objective

The main objective of this research is to develop ontology for Economic Performance Indicators based on GRI G4, and this will be achieved through the following sub-objectives:

- Identifying the classes, data properties, object properties for Economic Performance Indicators based on GRI G4.
- Transforming a conceptual model into a formalized model by using the Unified Modelling Language (UML) to represent ontology for Economic Performance Indicators.
- Implementing ontology by using OWL language and Protégé tools to encode the competency questions. Subsequent SPARQL Queries will be created after implementing all classes, data properties, object properties identified within GRI G4 for Economic Performance Indicators. Data instances will be collected online for four Australian companies listed with the ASX, including Origin Energy Limited, BHP Billiton, Amcor Limited, and Transurban Group.
- Evaluating the developed ontology for Economic Performance Indicators by a process of verification and validation. Schema Metrics and Knowledgebase Metrics will be used to verify the ontology. To validate the ontology, the answers to SPARQL Queries are extracted and the ontology for an Economic Performance Indicators is validated.

## 3. Materials and methods

### 3.1 Background

#### 3.1.1 Ontology

There are many existing definitions of ontology, arguments about what the definition of ontology is or ought to be [10], and debates regarding the best definition [11]. Studer, Benjamins, and Fensel definition of ontology as “a formal, explicit specification of a shared conceptualisation” is one



of the most comprehensive definitions available [12]. They define the terms: Explicit, Formal, and Shared as follows:

- Explicit: all elements of ontology are obviously defined.
- Formal: refers to the fact that the ontology should be machine readable, which excludes natural language.
- Shared: refers to consensual knowledge agreed on to be accepted by a group of people.

The definition introduced by Studer, Benjamins, and Fensel [12] is one of the most comprehensive forms available in the literature [13]. This research is based on this definition. The main uses of ontology are to share common understanding of terms for specific domain in the real world between people and computers, and to reuse it; if it is not reused, it provides limited benefits.

It should be noted that Ontological Engineering (OE) refers to any activities involved in the ontology building process and also include lifecycle, principles and methodologies used for its construction [13]. The main methodologies and methods used to build ontologies from scratch. These methodologies are related to its lifecycle. The lifecycle as a development process consists of different activities to design and evaluate ontologies. Until the mid-1990s this process was an “art rather an engineering activity” [13].

Scholars agree that concepts, relations, instances and axioms are the main components or basic and typical elements of ontology. Because of different ontology languages, the exact specification of these elements may vary according to the underlying knowledge model [22] [23]. Concepts are also known as classes of objects. Classes have been defined as “abstract or concrete, elementary or composite, real or fictitious”; in short, a concept can refer to just about anything including speech, actions or activities, strategies or plans, or cognitive processes, to name a few [23]. Relations represent a “type of association between concepts of the domain” [13]. Binary relationships refer to the relational links involving two concepts; roles describe binary relations between concepts; inverse relationships refer to binary relation links between two concepts in the opposite direction. There are three types of relationships: association relationship, inheritance relationship, and composition relationship are used in this research. Properties are also known as slots or roles or attributes of classes. Properties represent relationships that describe various features and attributes of the concept [24]. Object properties and datatype properties are two main types of properties. Object properties are relationships between two individuals and they use “vocabulary” and “semantic” to describe this relationship. Instances are also known as individuals. Instances represent “real-world individuals” or are used to represent elements or individuals in ontology [25]. Horridge stated that individuals, are also known as instances or “objects” in the interested domain. Individuals can be defined as being “instances of classes” [26]. Axioms refer to constraints used on values for classes or instances; the properties of relations are types of axioms and they include more general rules [24] [27].

### 3.1.2 Global Reporting Initiative

A comprehensive Sustainability Reporting Framework that is the most widely used around the world has been established and improved by the Global Reporting Initiative or GRI. The GRI is a leading organization in the sustainability field. The GRI Sustainability Report is a report issued by organizations (private, public, or non-profit) that reports their economic, environmental and social impacts, and the performance of their activities, products and services. Such reporting takes a Triple Bottom Line (TBL) approach. GRI considers an organization’s impacts and performance not only on in terms of its local economy but also in terms of its sustainable global impact. Many organizations, regardless of their type, size, sector or location, voluntarily use the GRI Framework to measure and report on their performance according to specific principles and indicators. This framework is a reporting system which includes the Reporting Guidelines, “the core document” or the “cornerstone” of this framework providing guidance on how organizations can disclose their sustainability performance and increase accountability [28] in addition to Sector Guidance and other resources. G4 is the latest version of GRI’s Sustainability Reporting Guidelines released in May 2013 after several previous versions of the Guidelines: the first version in 2000; the second generation (G2) in 2002; and the third generation (G3) in 2006. In 2011, the GRI updated and published the G3.1. [29]. Global Reporting Initiative, the Global Reporting Initiative logo, Sustainability Reporting Guidelines, and GRI are trademarks of the Global Reporting Initiative [30]-[33]. GRI includes sustainability reporting that principally applies to environmental issues as well as economic and social impacts. However, in Australia, GRI guidelines are for voluntary use by business firms for reporting on the three aforementioned dimensions of their activities, products, and services [32].

### 3.2 Conceptual framework

The scenario is illustrated in Figure 1. In a real-world use scenario of Sustainability Reporting, small, medium or large enterprises engage in this reporting process by following Sustainability Reporting Guidelines. Because of a lack of a standard application for the report generation, ontology is used to solve this problem by generating an Ontological Model for Sustainability Reporting including Economic Performance Indicators. This enables organizational sharing, communicating and reusing this Model for Economic Performance Indicators. The components of ontology are elicited from Sustainability Report that based on GRI G4 and they involved in ontology development process and resulted ontological model. The Ontology Development Process Model includes four phases: specification, conceptualization, formalization, and implementation [24] [34] [35] [36]. Through these steps, the purpose and the scope of the ontology are defined, the conceptual model is identified and formalized, and the formalized model is encoded. Then, to verify and validate the model, an outcome of this process is to create and assess an ontological model for Economic Performance Indicators based on GRI G4.

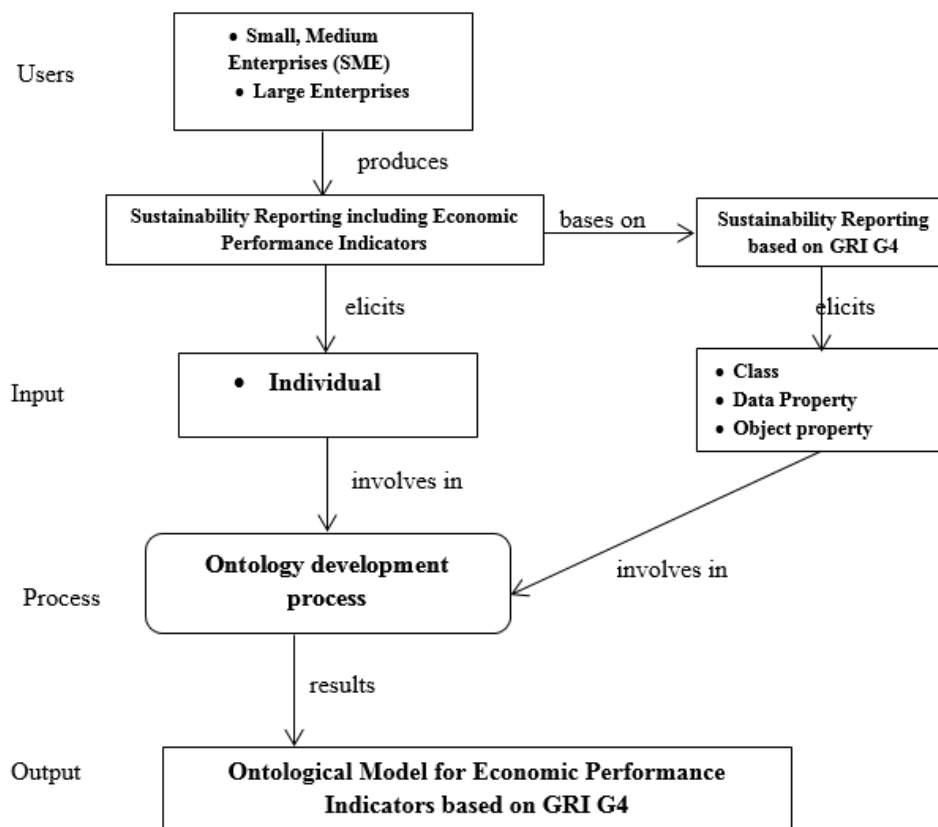
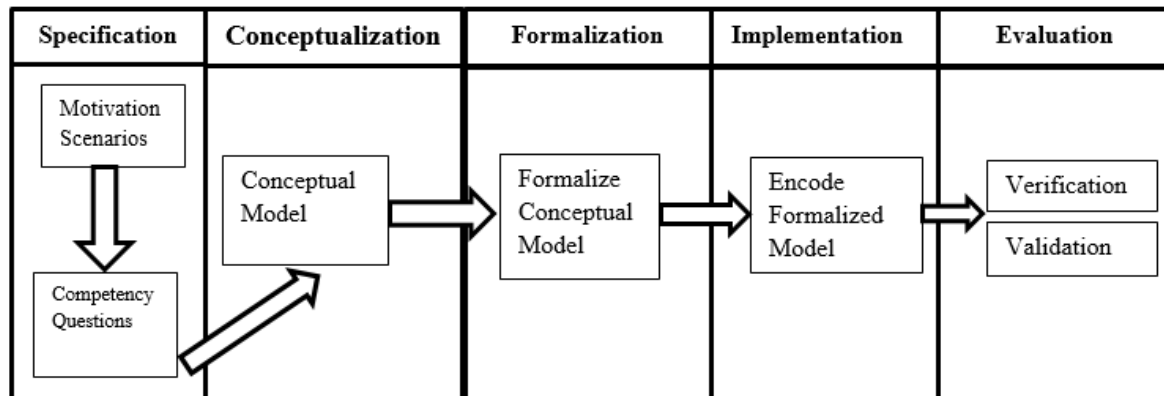


Figure 1 Conceptual framework

Figure 2 shows the contained tasks in each phase. In the specification phase, the motivation scenarios and competency questions need to be described. In the conceptualization phase, the conceptual models need to be defined. In the formalization phase, the conceptual models are required to be formalized. In the implementation phase, the ontology will be built by encoding [24] [34]-[38]. The following subsections will explain each phase.



**Figure 2** Tasks in each phase of the Economic Performance Indicator ontology development

### 3.2.1 Specification phase

The first development phase of ontology is the specification phase; this activity is ontology description (usually in natural language). The aim of this phase is to ‘state why the ontology is being built, what is intended uses are, who the users are, and which requirements the ontology should fulfil’ [39]. The first requirement is to describe the motivating scenario and present solutions to the problems arising in the scenario [40] as stated above. Uschold and Gruninger [36] and Uschold [37] identify the purpose and scope of ontology. Fernández-López, Gómez- Pérez, and Juristo [41] and Lopez et al. [35] show a brief example of ontology requirements specification document in the chemicals domain. The following information should be included in the specification phase. A detailed ontology requirements specification document (ORSD) is required in this phase as proposed by (Uschold 1996) [37]. The specifications of the Sustainability Reporting ontology are defined as follows:

Domain: Sustainability Reporting based on GRI Guidelines G4.

Purpose: Developing a Sustainability Reporting ontology-based knowledge base for software to automatically create GRI reports for the following reasons:

- 1) Enabling knowledge sharing among people, organizations, and software systems [24] [36] [42] [43] [44].
- 2) Reusing knowledge. The proposed ontology can be reused by organizations and can also be updated to adapt to new generations of GRI.

End users: Engaged stakeholder groups, for example, civil society, customers, employees, other workers and their trade unions, local communities, shareholders and providers of capital, and suppliers.

Level of formality of the implemented ontology: Semi-formal. This is the level of formality that will be used to codify the terms and their meanings in a language somewhere between natural language and a rigorous formal language [41]. Uschold and Gruninger [36] classify the level of formality into: highly informal, semi-informal, semi-formal or rigorously formal ontologies.

Scope: All components of Economic Performance Indicators defined according to GRI Guidelines G4.

Sources of knowledge:

1) Interviews with the experts in GRI Sustainability Reporting Guidelines because the ontologists and the GRI reporters are different jobs. However, in this research the ontology is used as a tool to design Economic Performance Indicators according to GRI G4. So, the reporters are the professionals experienced in the content of GRI reporting and the ontologists will structure the information of GRI G4 into: classes, properties, relationships, axioms and individual. Then Protégé is used to implement this ontology development process.

2) GRI Sustainability Reporting Guidelines G4: Reporting Principles and Standard Disclosures [21] and GRI Sustainability Reporting Guidelines G4: Implementation Manual [33].

The second requirement is to create ‘competency questions’ ‘CQ’ as the technique for establishing the ontology requirements [40]. Competency questions are queries written in natural language and the ontology to be built should be able to answer all questions raised by stakeholders and can be used to verify the correctness of the ontology with the ontology requirements identified (scope of the ontology) [39]. The main concepts and their properties, relations and formal axioms of the ontology are used to extract these questions and answers [45]. In this research, competency questions are created for data instances found in four Australian companies to implement ontology as can be seen two examples in this research.

### 3.2.2 Conceptualizations phase

The second step in the ontology lifecycle is conceptualization. The output of the first phase will be transformed into a conceptual model by means of conceptualization [46]. The aim of this activity is to structure the domain knowledge in a conceptual model in terms of the domain vocabulary identified in the ontology specification activity [41]. Weber [47] defines ‘Conceptual modelling’ as an ‘activity undertaken during information systems development to build a representation of selected semantics about some real-world domain’. According to Noy and McGuinness [24], the requirements for the conceptualization phase are:

1. Identify terminologies for Economic Performance Indicators in the GRI G4 Guidelines; and
2. Identify the classes, their properties, and the relationships between them as defined in GRI G4 Guidelines and create instances from actual sustainability report.

### 3.2.3 Formalization phase

The formalization phase is the core of an ontology development process. It involves transforming a conceptual model into a formalized model or semi-computable model [22] [46] [25]. Colomb [48] explained that a formal ontology is an “advanced knowledge representation system”. Guebitz, Schnedl, and Khinast [49] stated that creating a neutral ontology formulation, independent of implementation languages is the goal of this phase. There are different levels of the transformative process in relation to the conceptual model ranging from semi-formal to rigorously formal. The greater the formality, the greater is the amount of automation required to support ontology [37]. It depends on the implementation requirements of the ontology. Guebitz, Schnedl, and Khinast [49] presented the object-oriented modelling language as an appropriate formalism to represent ontology by using the Unified Modelling Language (UML). Thus, for the development of the sustainability report ontology, the formalization requires a notation system to formalize the sustainability report ontology conceptual model.

To create a formal ontology, all main structural components and their constraints must be explicitly described [49]. The object oriented modelling language can be used for ontology modelling. Cranefield and Purvis [50] suggested that UML as a static modelling notation can be used to model the “formal semantics” of ontologies. In this research, three types of relationships are identified between classes, which are: Association relationship, Inheritance relationship, and Composition relationship.

### 3.2.4 Implementation phase

This activity builds computable models in a formal language or representation of conceptual models by using an ontology language [46]. To implement computable models, there are tools used in different ontology languages as ontology editors. There are several languages: XML, RDF, OIL, DAML+OIL, OWL, CARIN, FLogic, Jess, and Prolog [25]. The requirements of the implementation phase are:

1. A formal language that can be used to encode the ontology; and
2. A tool that supports the ontology development activities.

In this research, Web Ontology Language OWL is used as a standard and broadly acceptable ontology language, which provides classes, data properties, object properties and individuals [51]. Protégé Onto Edit (protégé.stanford.edu) is used as a tool to represent ontology in a machine readable format. Ontologies are stored as Semantic Web documents (W3C OWL Working Group)<sup>1</sup>. The full ontology coding is available at <http://www.semanticweb.org/14174782/ontologies/2014/6/csr#>.

### 3.2.5 Evaluation phase

Evaluation is a ‘technical judgment of the content of the ontology with respect to a frame of which can be requirements specifications, competency questions or the real world during each phase and between phases of their lifecycle to guarantee to end users the consistency, completeness and conciseness of the ontologies definitions, documentations, and software’ [52] – [55]. Ontology evaluation includes:

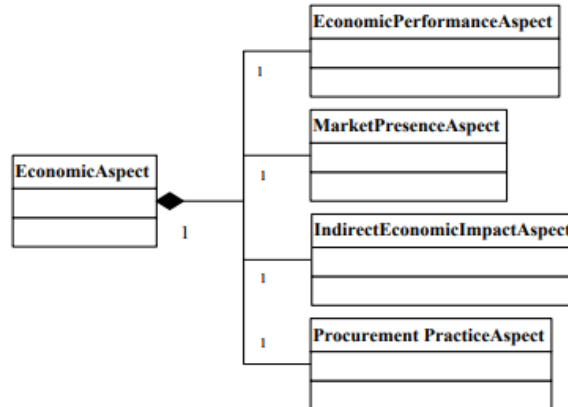
Ontology verification and  
Ontology validation

<sup>1</sup> <http://www.w3.org/TR/2012/REC-owl2-overview-20121211>

In this research, all classes, data properties, object properties identified for Economic Performance Indicators according to GRI G4. All instances data as identified from actual sustainability report for 4 Australian companies. Most definitions of classes can be found in [33].

#### 4. Results and discussion

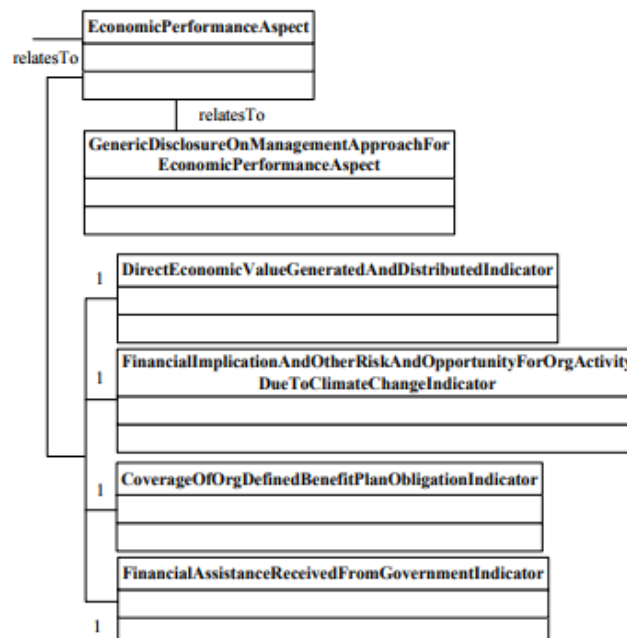
There are four Aspects as classes within the ‘Economic Category’ class – the ‘Economic Performance Aspect’ class, the ‘Market Presence Aspect’ class, the ‘Indirect Economic Impact Aspect’ class, and the ‘Procurement Practice Aspect’ class. The following subsection explains the ontology for each Aspect class.



**Figure 3** Ontology formalization for ‘Economic Aspect’ class

#### 4.1 Ontology for Economic Aspect class

This is the first aspect which addresses the “direct value generated” [3] of the organization’s activities and immediate consequences of monetary flows to stakeholders. There is a generic DMA and four indicators related to this indicator class as shown in Figure 4. In the following subsections, the ontologies for the four indicators of the class ‘Economic Performance Aspect’ are presented.

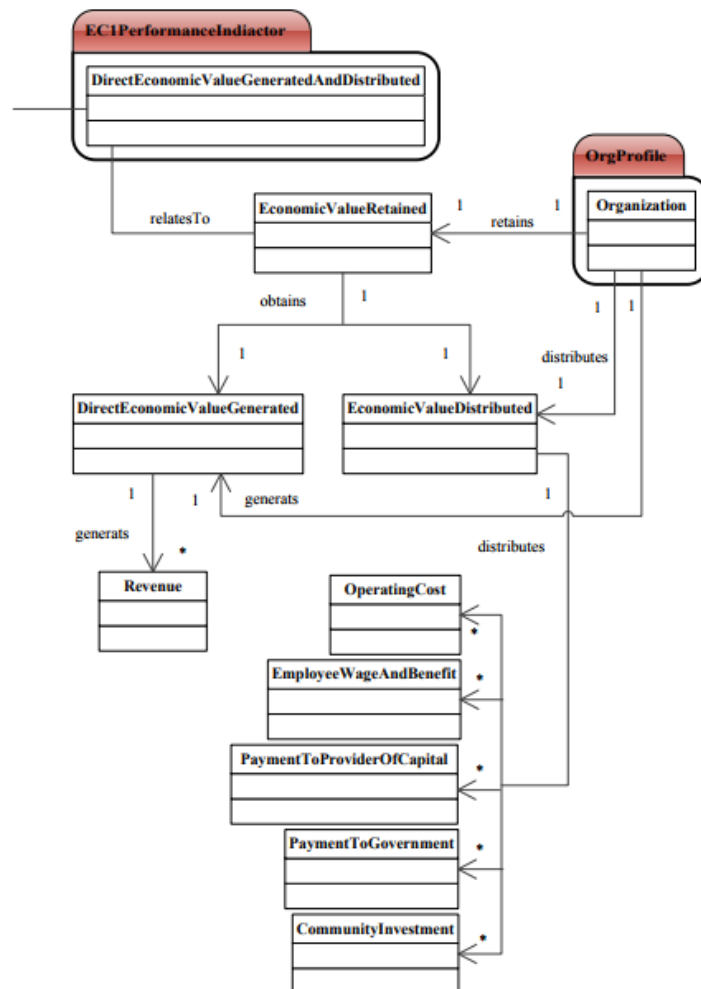


**Figure 4** Ontology formalization for ‘Economic Performance Aspect’ class

##### 4.1.1 Ontology for ‘Direct Economic Value Generated and Distributed Indicator’ class/ EC1

This indicator class concerns the economic value generated and distributed (EVG&D) (Figure 5). The concept that is related to this indicator is ‘Economic Value Retained’ class. The class ‘Organization’ retains

‘Economic Value Retained’. This class is obtained from the ‘Direct Economic Value Generated’ class and ‘Economic Value Distributed’ class. The class ‘Organization’ generates the ‘Direct Economic Value Generated’ class. In addition, the class ‘Organization’ distributes ‘Economic Value Distributed’ class. The class ‘Direct Economic Value Generated’ is generated from ‘Revenue’ class. The class ‘Economic Value Distributed’ is distributed to: ‘Operation Cost’ class; ‘Employee Wage and Benefit’ class; ‘Payment To providers of Capital’ class; ‘Payment To Government’ class; and ‘Community Investment’ class [33].



**Figure 5** Ontology formalization for ‘Direct Economic Value Generated And Distributed Indicator’ class

#### 4.1.2 Ontology for ‘Financial Implication And Other Risk And Opportunity For Org Activity Due To Climate Change Indicator’ class/ EC2

This indicator centres on how climate change affects economic performance. It is required to identify ‘Climate Change Risk’ class and ‘Climate Change Opportunity’ class that posed by ‘Climate Change’ class. The class ‘Climate Change Risk’ categorizes risk according to ‘Physical Risk’ class, ‘Regular Risk’ class, and ‘Other Risk’ class. The class ‘Climate Change Opportunity’ categorizes opportunity according to ‘Physical Opportunity’ class, ‘Regular Opportunity’ class and ‘Other Opportunity’ class [33].

#### 4.1.3 Ontology for ‘Coverage Of Org Defined Benefit Plan Obligation Indicator’ class/ EC3

This indicator class focuses on structure of retirement plan offered to employee. The concept that is related to this indicator is ‘Structure Of Retirement Plan Offered To Employee’ class whether is based on ‘Defined Benefit Plan’ class; ‘Defined Contribution Plan’ class; and ‘Other Type Of Retirement Benefit’ class. For class ‘Defined Benefit Plan’ whether is funded by ‘Org General Resource’ class or by the class ‘Separate Fund’ which is used to pay to ‘Pension Liability’ class which is kind of ‘Liability’ class. For class ‘Defined Contribution Plan’ is required to report ‘Percentage Of Salary’ class and ‘Level Of Participation’ class. The

‘Percentage Of Salary’ class which is contributed by employee and employer as ‘Contribution Of Employee’ class and ‘Contribution Of Employer’ class. For the class ‘Other Type Of Retirement Benefit’ is specified where not fully covered by general resource and separate fund. In addition, the class ‘Jurisdiction Regarding Calculation Plan Coverage’ is required to identify calculations used to determine plan coverage [33].

#### 4.1.4 Ontology for ‘Financial Assistance Received From Government Indicator’ class/ EC4

This indicator concerns the financial support received from government. The ‘Financial Assistance’ class is related to this indicator. The class ‘Organization’ receives ‘Financial Assistance’ class. It is received from the class ‘Government’ which is part of ‘Stakeholder Group Engaged By Org’ class. It is received in ‘Reporting Period’ class. The data properties can be found in [33].

### 4.2 Ontology for ‘Market Presence Aspect’ class

This is the second Aspect that focusses on “entry-level wage by gender compared to local minimum wage” [3]. This Aspect comprises generic DMA and two indicators as following.

#### 4.2.1 Ontology for ‘Ratio Of Standard Entry Level Wage By Gender Compared To Local Minimum Wage At Significant Locations Of Operation Indicator’ class/EC5

This indicator concentrates on entry level wage by gender compared to local minimum wage. The classes that are related to this indicator are: ‘Local Minimum Wage’; ‘Entry Level Wage’; and ‘Ratio Of Standard Entry Level Wage’ class which are presented at ‘Location Of Operation’. The fourth class is ‘Salaried Employment’ which is offered by the class ‘Organization’ [33].

#### 4.2.2 Ontology for ‘Proportion Of Senior Management Hired From Local Community At Significant Location Of Operation Indicator’ class/ EC6

This indicator concentrates on percentage of senior management at significant locations of operation that hired from the local community. So, the concept of ‘Proportion Of Senior Management’ class is related to this indicator class. It is required to report the ‘Percentage Of Senior Management’ class that is hired at ‘Location Of Operation’ class which is hired from ‘Local Community’ class [33].

### 4.3 Ontology for ‘Indirect Economic Impact Aspect’ class

This is the third Aspect that emphasizes “impact of infrastructure investments” in relation to local communities and regional economies [3]. There are generic and specific DMA classes and two indicators:

#### 4.3.1 Ontology for ‘Development and Impact of Infrastructure Investment and Service Supported Indicator’ class/ EC7

This indicator focuses on significant infrastructure investment in terms of its development and impact or service supported. The concept related to this indicator is the ‘Infrastructure Investment and Service Supported’ class that has an impact on ‘Community and Local Economy’ class [33].

#### 4.3.2 Ontology for ‘Significant Indirect Economic Impact Including Extent Of Impact Indicator’ class / EC8

The additional impacts that are generated by an organization through the economy in terms of financial flow are included in this indicator. It has indirect impacts as a participant or agent in socio-economic change, and in developing economies in terms of local communities and regional economies [33]. So, this indicator has significant positive and negative indirect economic impacts on ‘Local Community and Regional Economy’ class.

### 4.4 Ontology for ‘Procurement Practice Aspect’ class

This is the final aspect, the essence of which is “spending on local suppliers” [3]. There are generic and specific DMA classes associated with this aspect and only one indicator which is the Ontology for ‘Proportion Of Spending On Local Supplier At Significant Location Of Operation indicator’ class/ EC9. This indicator concentrates on ratio of local spending at significant locations of operation. The concept that relates to this indicator is ‘Percentage of Procurement Budget Spent On Local Supplier’ which is used for the class ‘Location of Operation’ [33].

In implementation phase, Web Ontology Language (OWL) is used as a standard and broadly acceptable ontology language which defines classes, data properties, object properties, and individuals. Protégé\_5.0\_beta (protégé.stanford.edu) is used as a tool to create ontologies. Ontologies are stored as Semantic Web documents

(W3C OWL Working Group)<sup>2</sup>. The full ontology coding is available at <http://www.semanticweb.org/14174782/ontologies/2014/6/csr#>.

In addition, only the following language elements are used: Owl:Ontology, owl:Class, owl: ObjectProperty, owl:DatatypeProperty, rdfs:subClassOf, rdf:datatype, rdfs:domain, and rdf:range [56].

Therefore, all classes' object properties, and data properties identified and formalized are created in Protégé\_5.0\_beta. The instances of classes are referenced from the four Australian companies mentioned before. According to the scope and purpose of ontology for a Economic Performance Indicators specified in phase 1, stakeholders need information about an Economic Performance Indicators disclosures, and therefore they raise questions. Competency questions are prepared as a standard technique in ontology engineering methodologies [36]. Grüninger and M.S.Fox [57] proposed competency questions as a methodology for evaluating ontologies. The query language is required to encode the competency questions appropriately [58].

#### 4.5 Competency questions and SPARQL queries for 'Economic Performance indicator' class

In this section, questions in natural language are detailed and covered all the instances in the ontology. All these questions are correct and complete. They are then transformed to SPARQL queries for inquiring the 'Economic Performance indicator' class as shown for example in Table 1 and Table 2.

**Table 1** Competency questions and SPARQL query for 'Direct Economic Value Generated' class

CQ60: What is the total value of direct economic value generated, by region, basis, and measurement unit currency for this company?
<pre> SPARQL query SELECT ?subject ?object WHERE {   ?subject     csr:directEconomicValueGeneratedBasis ?object }   csr:regionNameForDirectEconomicValueGenerated ?object }   csr:totalValueOfDirectEconomicValueGenerated ?object }   csr:totalValueOfDirectEconomicValueGeneratedByRegion ?object }   csr:measurementUnitCurrency ?object } </pre>

**Table 2** Competency questions and SPARQL query for 'Revenue' class

CQ61: What is the total value of revenue by region, basis, and measurement unit currency for this company?
<pre> SPARQL query SELECT ?subject ?object WHERE {   ?subject     csr:revenueName     csr:revenueandOtherIncomeBasis ?object }   csr:regionNameForRevenueandOtherIncome ?object }   csr:totalValueOfRevenueandOtherIncome ?object }   csr:totalValueOfRevenueandOtherIncomeByRegion ?object }   csr:measurementUnitCurrency ?object } </pre>

#### 5. Ontology evaluation

Weller [22] considered the evaluation of ontology as an additional process. It incorporates verification and validation. It refers to "judging the quality of the content of the ontology" [22] [54]. To evaluate the ontology, there are many approaches based on the level of evaluation [59] and relevant criteria identified [54]. It is performed differently depending on the methodologies used to build ontology [54]. Grüninger and Fox [40] propose to evaluate ontology by identifying a set of competency questions. These questions need to be formalized in a query language to encode the competency questions using an appropriate tool [58]. The form of questions is used in this evaluation.

<sup>2</sup> <http://www.w3.org/TR/2012/REC-owl12-overview-20121211/>



Ontology evaluation includes technical evaluation. The core of technical evaluation is the evaluation of the definitions that consider different aspects of ontology in terms of vocabulary, structure, content, syntax, semantic and representation that satisfy the criteria of completeness, consistency, and conciseness of definitions [58][54]. To assess specific features of ontology, technical evaluation methods are required.

Verification is the process whereby the correctness of ontology is ascertained. The process involves the creation of an ontology whose definitions adequately meets its requirements and competency questions, and function correctly in the real world [52] – [55]. Ontology verification is quite distinct from ontology validation. Ontology verification ensures that the ontology was created correctly, whereas ontology validation determines whether the right ontology was created [58]. It deals with the problem of the three Cs: (consistency, completeness, and conciseness) [55] [53] [52]. Gómez-Pérez [55] defines the three Cs as follows:

Consistency refers to definitions in the ontology that are semantically consistent;

Completeness refers to the extension, degree, amount of or coverage of the information about the real world in the ontology;

Conciseness refers to the usefulness and precision of all the information gathered in the ontology.

It requires a common understanding between the domain knowledge experts and ontology engineering experts. For this purpose, SPARQL queries are used to extract answers for the competency questions after SPARQL queries are created as shown in Table 1 and Table 2. The extracted answers for the competency questions as shown in Figure 6 and Figure 7 are the correct answers that confirm that the reported data are instantiated and correctly describe all relationships between the data. Therefore, the developed ontology for the Economic Performance Indicators is valid.

SPARQL query's answer to CQ60(a-e)	
a-Direct economic value generated basis: accruals basis.	
b- Region name for direct economic value generated: Africa and Other, Australia and Asia, Europe, North America, South America.	
c-Total value of direct economic value generated: 68083.	
d1- Total value of direct economic value generated by Africa and Other region: 5007.	
d2- Total value of direct economic value generated by Australia and Asia region: 40917.	
d3- Total value of direct economic value generated by Europe region: 172.	
d4- Total value of direct economic value generated by North America region: 9468.	
d5- Total value of direct economic value generated by South America region: 12519.	
e- Measurement unit of currency: \$ US million.	
subject	object
bhpDirectEconomicValueGeneratedBasis	"Accruals basis."^^<http://www.w3.org/2001/XMLSchema#string>
subject	object
bhpRegionNameForDirectEconomicValueGenerated	"Africa and Other, Australia and Asia, Europe, North America, South America."^^<http://www.w3.org/2001/XMLSchema#string>
subject	object
bhpTotalValueOfDirectEconomicValueGenerated	"68083"^^<http://www.w3.org/2001/XMLSchema#decimal>
subject	object
bhpTotalValueOfDirectEconomicValueGeneratedByAfricaAndOtherRegion	"5007"^^<http://www.w3.org/2001/XMLSchema#decimal>
bhpTotalValueOfDirectEconomicValueGeneratedByAustraliaAndAsiaRegion	"40917."^^<http://www.w3.org/2001/XMLSchema#decimal>
bhpTotalValueOfDirectEconomicValueGeneratedByEuropeRegion	"172."^^<http://www.w3.org/2001/XMLSchema#decimal>
bhpTotalValueOfDirectEconomicValueGeneratedByNorthAmericaRegion	"9468."^^<http://www.w3.org/2001/XMLSchema#decimal>
bhpTotalValueOfDirectEconomicValueGeneratedBySouthAmericaRegion	"12519."^^<http://www.w3.org/2001/XMLSchema#decimal>
subject	object
bhpMeasurementUnitCurrency	"\$ US million."^^<http://www.w3.org/2001/XMLSchema#string>

Figure 6 SPARQL query result for CQ60 in Table 1 related to 'Direct Economic Value Generated' class

SPARQL query's answer to CQ61(a-f)	
a- Revenue name: Revenue and other income.	
b- Revenue and other income basis: accruals basis.	
c- Region name for revenue and other income: Africa and Other, Australia and Asia, Europe, North America, South America.	
d- Total value of Revenue and other income: 68083.	
e1- Total value of Revenue and other income by Africa and Other region: 5007.	
e2- Total value of Revenue and other income by Australia and Asia region: 40917.	
e3- Total value of Revenue and other income by Europe region: 172.	
e4- Total value of Revenue and other income by North America region: 9468.	
e5- Total value of Revenue and other income by South America region: 12519.	
f- Measurement unit of currency: \$ US million.	
subject	object
bhpRevenueName	"Revenue and other income."^^<http://www.w3.org/2001/XMLSchema#string>
subject	object
bhpRevenueAndOtherIncomeBasis	"Accruals basis."^^<http://www.w3.org/2001/XMLSchema#string>
subject	object
bhpRegionNameForRevenueAndOtherIncome	"Africa and Other, Australia and Asia, Europe, North America, South America."^^<http://www.w3.org/2001/XMLSchema#string>
subject	object
bhpTotalValueOfRevenueAndOtherIncome	"68083"^^<http://www.w3.org/2001/XMLSchema#decimal>
subject	object
bhpTotalValueOfRevenueAndOtherIncomeByAfricaAndOtherRegion	"5007"^^<http://www.w3.org/2001/XMLSchema#decimal>
bhpTotalValueOfRevenueAndOtherIncomeByAustraliaAndAsiaRegion	"40917"^^<http://www.w3.org/2001/XMLSchema#decimal>
bhpTotalValueOfRevenueAndOtherIncomeByEuropeRegion	"172"^^<http://www.w3.org/2001/XMLSchema#decimal>
bhpTotalValueOfRevenueAndOtherIncomeByNorthAmericaRegion	"9468"^^<http://www.w3.org/2001/XMLSchema#decimal>
bhpTotalValueOfRevenueAndOtherIncomeBySouthAmericaRegion	"12519"^^<http://www.w3.org/2001/XMLSchema#decimal>
subject	object
bhpMeasurementUnitCurrency	"\$ US million."^^<http://www.w3.org/2001/XMLSchema#string>

**Figure 7** SPARQL query result for CQ61 in Table 2 related to 'Revenue' class

Moreover, Schema Metrics and Knowledgebase Metrics were the means used to verify the ontology for this research, [60] [61]. These metrics include:

- Relationship Richness (RR)
- Attribute Richness (AR)
- Inheritance Richness (IR)
- Class Richness (CR)
- Average Population (P)

According to Table 3, the total number of classes, data properties, object properties, instances, sub-classes, and non-empty classes of Economic Aspects are 64, 193, 59, 173, 0, and 29 respectively. Therefore, the RR is 1.00 because the number of SC is 0. Each class on average has data properties of 3.02. In addition, the CR

is 0.45. Besides, each class has an average instance of 2.70 which shows the richness of instances in particular for EC1, EC2, EC9, EC3, EC7, and EC6.

**Table 3** Schema Metrics and Knowledgebase Metrics for Economic (EC) Aspects

Definition of class	Class (C)	Data property (att)	Object property (P)	Instance (I)	Number of Sub-class (SC)	C'	RR	AR	IR	CR	Average Population (P)
EC Category	1.00	0.00	1.00	0.00	0.00	0.00	1.00	0.00	0.00	0.00	0.00
EC Aspect	4.00	0.00	1.00	0.00	0.00	0.00	1.00	0.00	0.00	0.00	0.00
Economic Performance Aspect	5.00	6.00	3.00	0.00	0.00	0.00	1.00	1.20	0.00	0.00	0.00
EC1	9.00	54.00	8.00	89.00	0.00	9.00	1.00	6.00	0.00	1.00	9.89
EC2	9.00	60.00	5.00	60.00	0.00	9.00	1.00	6.67	0.00	1.00	6.67
EC3	13.00	23.00	9.00	18.00	0.00	5.00	1.00	1.70	0.00	0.38	1.38
EC4	2.00	4.00	6.00	0.00	0.00	0.00	1.00	2.00	0.00	0.00	0.00
Market Presence Aspect	3.00	6.00	3.00	0.00	0.00	0.00	1.00	2.00	0.00	0.00	0.00
EC5	5.00	5.00	6.00	0.00	0.00	0.00	1.00	1.00	0.00	0.00	0.00
EC6	2.00	4.00	4.00	1.00	0.00	2.00	1.00	2.00	0.00	1.00	0.50
Indirect Economic Impact	4.00	10.00	3.00	0.00	0.00	0.00	1.00	2.50	0.00	0.00	0.00
EC7	2.00	5.00	3.00	2.00	0.00	2.00	1.00	2.50	0.00	1.00	1.00
EC8	1.00	2.00	2.00	0.00	0.00	0.00	1.00	2.00	0.00	0.00	0.00
Procurement Practice	3.00	11.00	2.00	0.00	0.00	0.00	1.00	3.67	0.00	0.00	0.00
EC9	1.00	3.00	3.00	3.00	0.00	2.00	1.00	3.00	0.00	2.00	3.00
<b>Total</b>	<b>64.00</b>	<b>193.00</b>	<b>59.00</b>	<b>173.00</b>	<b>0.00</b>	<b>29.00</b>	<b>1.00</b>	<b>3.02</b>	<b>0.00</b>	<b>0.45</b>	<b>2.70</b>

## 6. Discussion

In this paper, the implemented ontology using OWL language and the Protégé tool is validated through the competency questions written in SPARQL Queries as shown in Table 1 and Table 2. Instances data were collected online for four Australian companies listed within the ASX for FY 2014; these are ORG, AMC, TCL, and BHP. The evaluation ontology of content to meet the 3Cs criteria of completeness, consistency, and conciseness was verified and the answers to the SPARQL Queries were obtained. These answers show that the reported data are instantiated and correctly describe all relationships between the data. Hence, the developed ontology for 'Economic Performance Indicator' is valid. Thus, the fourth objective of this research, which is to develop ontology for 'Economic Performance Indicator' class, was achieved. The main contribution of the

research is that it provides a formal framework for concepts, properties, and relationships for 'Economic Performance Indicator' class based on GRI G4 guidelines. The framework facilitates knowledge-sharing among stakeholders and computer software through a shared and common understanding of terms and vocabulary for 'Economic Performance Indicator' class. It also helps to store knowledge in a repository which can be automatically renewed to be compatible with the new generation of GRI.

The majority of instances relating to economic indicators' data instances was extracted from BHP, in particular for EC1, EC2, and EC9 (full disclosures), EC3 and EC6 (partial disclosures). This company is unique in terms of the quantity and quality of information disclosed. Whereas, the ORG data instances disclosure for EC7 was found to be optimal. There was a dearth of disclosure for EC4, EC5, and EC8 by any company in the sample. The valid answers are appeared. The summary of Schema Metrics and Knowledgebase Metrics for 'Economic Performance Indicator' class in terms of total number of classes, data properties, object properties, instances, number of sub-classes and non-empty classes were 64, 193, 59, 173, 0, and 29 respectively. Therefore, the RR is 1.00 because the number of SC is 0. Each class on average has data properties of 3.02. In addition, the CR is 0.45. Besides, each class has an average instance of 2.70 which shows the richness of instances in particular for EC1, EC2, EC9, EC3, EC7, and EC6. The content of the ontology was thereby validated. SPARQL queries were used to extract answers for the competency questions and correctly describe all relationships between the data within the inclusive set. Therefore, the developed ontology for the Economic Performance Indicator is active.

## 7. Conclusion and future work

This paper is aimed at formally modelling the real world of Economic Performance Indicators within Sustainability Reporting. Ontology has provided a shared and common understanding of terms and vocabulary that can be communicated among stakeholders in an organization, and computer software to facilitate the sharing and reutilization of knowledge. The methodology adopted included four phases: specification, conceptualization, formalization, and implementation. A requirement specification for Economic Performance Indicators ontology was created by identifying the intended scope and the purpose to address the various ontology scenarios. The classes, properties, and relationships for Economic Performance Indicators based on the GRI G4 were identified. A conceptual model was transformed into a formalized model using UML to represent the ontology formalization for 'Economic Performance Indicator' class. However, using SPARQL to access information in the ontology is sometimes too complicated for end users who have little knowledge of the language. Therefore, in the future work, we plan to develop an application that can support end users to effectively access and manage knowledge captured in the Ontology for Economic Performance Indicators Based on Global Reporting Initiative (GRI) G4. In addition, an inference and logic reasoning ability will be applied for this research in the future.

## Acknowledgement

We would like to thank Dr. Alina Lee, Dr. Gordon Woodbine, and Dr. Hai Dong for their insightful vision, support and valuable comments on this study.

## References

- [1] UMEP, KPMG, Global Reporting Initiative, and Centre for Corporate Governance in Africa. 2013. Carrots and Sticks: Sustainability Reporting Policies Worldwide - Today's Best Practice, Tomorrow's Trends. <https://www.globalreporting.org/resourcelibrary/Carrots-and-Sticks.pdf>.
- [2] Buhr, Nola. 2010. "Histories of and Rationales for Sustainability Reporting." In *Sustainability Accounting and Accountability*, eds Jeffrey Unerman, Jan Bebbington and Brendan O'Dwyer, 57-69. London Routledge.
- [3] English, Denise M., and Diane K.Schooley. 2014. "The Evolution of Sustainability Reporting." *CPA Journal* 84(3):26-35. <http://search.ebscohost.com.dbgw.lis.curtin.edu.au/login.aspx?direct=true&db=bth&AN=94811193&site=ehost-live>.
- [4] Kolk, Ans. 2004. "A Decade of Sustainability Reporting: Developments and Significance." *International Journal of Environment and Sustainable Development* 3 (1): 51-64.
- [5] Deegan, Craig. 2014. *Financial Accounting Theory*. 4E ed. Australia: McGraw-Hill Education (Australia) Pty Ltd.
- [6] Christofi, Andreas, Petros Christofi, and Seleshi Sisaye. 2012. "Corporate Sustainability: Historical Development and Reporting Practices." *Management Research Review* 35 (2): 157-172.

- [7] Joseph, George. 2012. "Ambiguous but Tethered: An Accounting Basis for Sustainability Reporting." *Critical Perspectives on Accounting* 23 (2): 93-106. doi: <http://dx.doi.org/10.1016/j.cpa.2011.11.011>.
- [8] Church, Kim S., and Rod E. Smith. 2007. "An Extension of the REA Framework to Support Balanced Scorecard Information Requirements." *Journal of Information Systems* 21 (1): 1-25. <http://search.ebscohost.com/login.aspx?direct=true&db=bth&AN=24496336&site=ehost-live>.
- [9] Gruber, T. 2009. "Ontology." In *Encyclopedia of Database Systems*, eds L. Liu and M. T. Ozsu, 1963-1965. Berlin: Springer.
- [10] Uschold, Mike, and Austin Tate. 1998. "Putting Ontologies to Use." *The Knowledge Engineering Review* 13 (01): 1-3. doi: doi:null.
- [11] Borst, Willem Nico. 1997. "Construction of Engineering Ontologies for Knowledge Sharing and Reuse." Universiteit Twente. <http://doc.utwente.nl/17864/>.
- [12] Studer, Rudi, V. Richard Benjamins, and Dieter Fensel. 1998. "Knowledge Engineering: Principles and Methods." *Data & Knowledge Engineering* 25 (1-2): 184. doi: [http://dx.doi.org/10.1016/S0169-023X\(97\)00056-6](http://dx.doi.org/10.1016/S0169-023X(97)00056-6).
- [13] Corcho, Oscar, Mariano Fernandez-Lopez, and Asuncion Gomez-perez. 2007. "Ontological Engineering: What Are Ontologies and How Can We Build Them?" In *Handbook on Ontologies*, eds Steffen Staab and Rudi Studer, 44-70. Springer.
- [14] Herzig, Christian, and Stefan Schaltegger. 2006. "Corporate Sustainability Reporting: An Overview." In *Sustainability Accounting and Reporting*, eds Stefan Schaltegger, Martin Bennett and Roger Burritt, 301-324. Springer Netherlands.
- [15] Chou, T.H., J.A. Vassar, and B. Lin. 2008. "Knowledge Management Via Ontology Development in Accounting." *Kybernetes* 37 (1): 36-48.
- [16] Teller, Pierre. 2008. "The Use of a Formal Representation of Accounting Standards." *International Journal of Computer Science and Applications* 5 (3b): 93-116.
- [17] Chou, Chi-Chun, and Yu-Liang Chi. 2010. "Developing Ontology-Based Epa for Representing Accounting Principles in a Reusable Knowledge Component." *Expert Systems with Applications* 37 (3): 2316-2323. doi: doi:10.1016/j.eswa.2009.07.058.
- [18] Smeureanu, I., A. Dio teanu, C. Delcea, and L. Cotfas. 2011. "Business Ontology for Evaluating Corporate Social Responsibility." *The Amfiteatru Economic Journal* 13 (29): 28-42.
- [19] Weigand, Hans, and Philip Elsas. 2012. "Model-Based Auditing Using REA." *International Journal of Accounting Information Systems* 13 (3): 287-310. doi: <http://dx.doi.org/10.1016/j.accinf.2012.06.013>.
- [20] Weigand, H., P. Johannesson, and M. Bergholtz. 2015. "Accounting for Service Value - an Ontological Approach" *Research Challenges in Information Science (RCIS), 2015 IEEE 9th International Conference on*, doi: 10.1109/RCIS.2015.7128876.
- [21] Global Reporting Initiative. 2013a. *G4 Sustainability Reporting Guidelines: Implementation Manual*. Amsterdam. [www.globalreporting.org](http://www.globalreporting.org).
- [22] Weller, Katrin. 2010. *Knowledge Representation in the Social Semantic Web*. Germany: Walter de Gruyter GmbH & Co. KG.
- [23] Gomez-Perez, A., and O. Corcho. 2002. "Ontology Languages for the Semantic Web." *Intelligent Systems, IEEE* 17 (1): 54-60. doi: 10.1109/5254.988453.
- [24] Noy, Natalya F., and Deborah L. McGuinness. 2001. "Ontology Development 101: A Guide to Creating Your First Ontology." Stanford knowledge systems laboratory technical report KSL-01-05 and Stanford Medical Informatics Technical Report SMI-2001-0880.
- [25] Corcho, Oscar, Mariano Fernández-López, Asunción Gómez-Pérez, and Angel López-Cima. 2005. "Building Legal Ontologies with Methontology and Webode." In *Law and the Semantic Web*, eds V. Richard Benjamins, Pompeu Casanovas, Joost Breuker and Aldo Gangemi, 145. Springer.
- [26] Horridge, Matthew. 2011. *A Practical Guide to Building OWL Ontologies Using Protege 4 and Co-Ode Tools 1.3 ed*: University of Manchester.
- [27] Stevens, Robert, Carole A. Goble, and Sean Bechhofer. 2000. "Ontology-Based Knowledge Representation for Bioinformatics." *Oxford Journals Life Sciences & Mathematics & Physical Sciences* 1 (4): 398-414.
- [28] Moneva, J. M, Pablo Archel, and Carmen Corra. 2006. "GRI and the Camouflaging of Corporate Unsustainability." *Accounting Forum* 30 (2): 121-137. doi: [www.elsevier.com/locate/accfor](http://www.elsevier.com/locate/accfor).
- [29] Global Reporting Initiative. 2015. What Is GRI? Accessed October 15, [www.globalreporting.org/information/about-gri/what-is-GRI/Pages/default.aspx](http://www.globalreporting.org/information/about-gri/what-is-GRI/Pages/default.aspx).

- [30] \_\_\_\_\_. 2000. Sustainability Reporting Guidelines <http://www.globalreporting.org>.
- [31] \_\_\_\_\_. 2000-2006 GRI Version 3.0a. Economic Performance Indicators. <http://www.globalreporting.org>.
- [32] \_\_\_\_\_. 2002. GRI: Sustainability Reporting Guidelines. <http://www.globalreporting.org>.
- [33] \_\_\_\_\_. 2013b. G4 Sustainability Reporting Guidelines: Implementation Manual. Amsterdam. [www.globalreporting.org](http://www.globalreporting.org).
- [34] Fernández-López, Mariano, Asunción Gómez-Pérez, and Natalia Juristo. 1997a. "Methontology: From Ontological Art Towards Ontological Engineering" Proceedings of the Ontological Engineering AAAI-97 Spring Symposium held in 24-26 March, Stanford University, California: [www.aaai.org](http://www.aaai.org).
- [35] Lopez, M. F., A. Gomez-Perez, J. P. Sierra, and A. P. Sierra. 1999. "Building a Chemical Ontology Using Methontology and the Ontology Design Environment." *Intelligent Systems and their Applications*, IEEE 14 (1): 37-46. doi: 10.1109/5254.747904.
- [36] Uschold, Mike, and Michael Gruninger. 1996. "Ontologies: Principles, Methods and Applications." *The Knowledge Engineering Review* 11 (02): 93-136. doi: doi:10.1017/S0269888900007797.
- [37] Uschold, Mike. 1996. "Building Ontologies: Towards a Unified Methodology" In 16th Annual Conference of the British Computer Society Specialist Group on Expert Systems, Cambridge, UK: .
- [38] Staab, Steffen, Rudi Studer, H-P Schnurr, and York Sure. 2001. "Knowledge Processes and Ontologies." *Intelligent Systems*, IEEE 16 (1): 26-34.
- [39] Suárez-Figueroa, MariCarmen, Asunción Gómez-Pérez, and Boris Villazón-Terrazas. 2009. "How to Write and Use the Ontology Requirements Specification Document." In *On the Move to Meaningful Internet Systems: Otm 2009*, eds Robert Meersman, Tharam Dillon and Pilar Herrero, 966-982. Springer Berlin Heidelberg.
- [40] Grüninger, Michael, and Mark S Fox. 1995. "Methodology for the Design and Evaluation of Ontologies" Workshop on Basic Ontological Issues in Knowledge Sharing, IJCAI-95 held in Montreal, Quebec Canada: [www.ijcai.org/past/ijcai-95](http://www.ijcai.org/past/ijcai-95).
- [41] Fernández-López, Mariano, Asunción Gómez-Pérez, and Natalia Juristo. 1997b. "Methontology: From Ontological Art Towards Ontological Engineering" In Proceedings of the Ontological Engineering AAAI-97 Spring Symposium held in 24-26 March, Stanford University, California: [www.aaai.org](http://www.aaai.org).
- [42] Duineveld, A. J., R. Stoter, M. R. Weiden, B. Kenepa, and V. R. Benjamins. 2000. "Wondertools? A Comparative Study of Ontological Engineering Tools." *International Journal of Human-Computer Studies* 52 (6): 1111-1133. doi: <http://dx.doi.org/10.1006/ijhc.1999.0366>.
- [43] Chandrasekaran, Balakrishnan, John R Josephson, and V Richard Benjamins. 1998. "Ontology of Tasks and Methods" Knowledge Acquisition Workshop, Banff: <http://ksi.cpsc.ucalgary.ca/KAW/KAW98/chandra/index.html>.
- [44] Gruninger, Michael, and Jintae Lee. 2002. "Ontology Applications and Design." *Communications of the ACM* 45 (2): 39-41.
- [45] Gomez-Perez, Asuncion, Mariano Fernandez-Lopez, and Oscar Corcho. 2004. *Ontological Engineering with Examples from the Areas of Knowledge Management, E-Commerce and the Semantic Web*. London: springer.
- [46] Corcho, Oscar, Mariano Fernandez-Lopez, and Asuncion Gomez-perez. 2007. "Ontological Engineering: What Are Ontologies and How Can We Build Them?" In *Handbook on Ontologies*, eds Steffen Staab and Rudi Studer, 44-70. Springer.
- [47] Weber, Ron. 2003. "Conceptual Modelling and Ontology: Possibilities and Pitfalls" *Journal of Database Management* 14 (3): P.1.
- [48] Colomb, Robert M. 2007. *Ontology and the Semantic Web*. Vol. 156. Netherlands: IOS Press.
- [49] Guebitz, Brigitte, Hubert Schnedl, and Johannes G Khinast. 2012. "A Risk Management Ontology for Quality-by-Design Based on a New Development Approach According Gamp 5.0." *Expert Systems with Applications* 39 (8): 7291-7301.
- [50] Cranefield, Stephen, and Martin Purvis. 1999. *UML as an Ontology Modelling Language*.
- [51] Horridge, Matthew. 2011. *A Practical Guide to Building OWL Ontologies Using Protege 4 and Co-Ode Tools 1.3 ed*: University of Manchester.
- [52] Gómez-Pérez, Asunción. 1995. "Some Ideas and Examples to Evaluate Ontologies" *Artificial Intelligence for Applications*, 1995. Proceedings., 11th Conference on: IEEE.
- [53] \_\_\_\_\_. 1996. "Towards a Framework to Verify Knowledge Sharing Technology." *Expert Systems with Applications* 11 (4): 519-529. doi: [http://dx.doi.org/10.1016/S0957-4174\(96\)00067-X](http://dx.doi.org/10.1016/S0957-4174(96)00067-X).

- [54] ———. 2001. "Evaluation of Ontologies." *International Journal of Intelligent Systems* 16 (3): 391-409. doi: 10.1002/1098-111x(200103)16:3<391::aid-int1014>3.0.co;2-2.
- [55] ———. 2004. "Ontology Evaluation." In *Handbook on Ontologies*, 251-273. Springer.
- [56] Hepp, Martin. 2008. "Goodrelations: An Ontology for Describing Products and Services Offers on the Web." In *Knowledge Engineering: Practice and Patterns*, 329-346. Springer.
- [57] Grüninger, Michael, and M.S.Fox. 1994. "The Role of Competency Questions in Enterprise Engineering" In *proceedings IFIP WG5.7 Workshop on Benchmarking—Theory and Practice*, Trondheim, Norway: Springer.
- [58] Vrandečić, Denny. 2010. "Ontology Evaluation." KIT Karlsruhe Institute of Technology, Karlsruhe, Germany.
- [59] Brank, Janez, Marko Grobelnik, and Dunja Mladenić. 2005. "A Survey of Ontology Evaluation Techniques" In *Proceedings of the Conference on data mining and data warehouse (SiKDD2005)*, Ljubljana, Slovenia: ailab.ijs.si/dunja/SiKDD2005.
- [60] Tartir, Samir, I. Budak Arpinar, and Amit P Sheth. 2010. "Ontological Evaluation and Validation." In *Theory and Applications of Ontology: Computer Applications*, eds Roberto Poli, Michael Healy and Achilles Kameas, 115-130. Springer Netherlands.
- [61] Tartir, Samir, I Budak Arpinar, Michael Moore, Amit P Sheth, and Boanerges Aleman-Meza. 2005. "Ontoqa: Metric-Based Ontology Quality Analysis" *Knowledge Acquisition from Distributed, Autonomous, Semantically Heterogeneous Data and Knowledge Sources (KADASH)*, Houston, USA: [www.cild.iastate.edu/events/KADASH](http://www.cild.iastate.edu/events/KADASH).

# A Multi-agent Approach for Semantic Annotation of Source Code Artefact

Pornpit Wongthongtham<sup>1,\*</sup> Udsanee Pakdeetrakulwong<sup>2,\*</sup> Suksawat Sae-Lim<sup>2</sup>, Worachet Uttha<sup>2</sup>, Sutarat Chaonafang<sup>2</sup>, Suphitcha chanrueang<sup>2</sup>, Supakit Nakpomchin<sup>2</sup>, Somkiat Chormuan<sup>2</sup>, Naruapon Suwanwijit<sup>2</sup>

<sup>1</sup>School of Information Systems, Curtin University, Western Australia, Australia

<sup>2</sup>Nakhon Pathom Rajabhat University, Nakhon Pathom, Thailand

## Abstract

A large volume of software project information is produced in software projects. Manually transforming or mapping them into a semantically rich form for shared understanding is time-consuming, laborious, tedious and prone to error. Hence, it is important to use a systematic approach to automate the knowledge capture of software project information. In this paper, the active Software Engineering Ontology through Multi-agent System (SEOMAS) approach for automated knowledge capture of software project information is proposed. The agents utilise the Software Engineering Ontology (SE Ontology) to capture knowledge from software development artefacts during the daily software development activity. The captured knowledge is populated as new instances in the SE Ontology repository to allow project team members and software agents to access it. It has been demonstrated that the captured knowledge can be put to practical use to clarify any ambiguity in remote communication and to facilitate effective and efficient coordination and knowledge sharing within a software development project.

**Keywords:** Multi-agent, Ontology, Software Development

## 1. Introduction

Various types of software project information produced throughout the software development life cycle describe different levels of abstraction and perspectives of a software system. Nonetheless, they are in syntactic format that does not facilitate the understanding of the concepts or meaning. The syntactic representation of software project information produces several issues such as ambiguities, difficulty in data integration, limitation of information retrieval, etc. These problems are more significant in a multi-site software development environment where project team members are dispersed across several locations and face-to-face communication (e.g., formal or information meeting) is limited. As a result, software project information should be transformed into semantic representation to alleviate the aforementioned issues. Some existing approaches have been introduced to capture the semantics of a software project. However, many of them are based on manual approaches or require effort from project team members to carry out additional steps in the knowledge capturing process because they are not integrated in a software development process. The manual capturing of knowledge of software project information is time-consuming, labour-intensive, tedious and error-prone task. In order to tackle these issues, there is the need for a systematic approach that can automatically capture knowledge of software project information and that is seamlessly integrated in a software development process. Once this information has been captured and conceptualised, it can be semantically interlinked with other relevant information. It can then be used to clarify any ambiguity in communication and to enable knowledge sharing among team members. This knowledge is also in machine-readable format which means that it can be understood by software agents. As a result, the agents can make use of this knowledge to assist project teams with their software development activities such as managing project issues, monitoring software project status, suggesting solutions or experts.

## 2. Materials and methods

### 2.1. Related works

Knowledge assimilation is the process of capturing and representing the domain-specific knowledge in a formal conceptual model [1]. When large amounts of knowledge need to be captured, an important point is the assimilation of extracted knowledge by means of systematic approaches that do not require great amount of human effort. The captured knowledge can be conceptually represented using the ontological model. In the

\* Corresponding author; e-mail: <sup>1\*</sup>ponnie.clark@curtin.edu.au, <sup>2\*</sup>udsanee@webmail.npru.ac.th



literature, several studies have proposed the use of ontology-based semantic annotation, or semantic annotation for short, to express a formal representation of the resource's content by connecting it to concepts defined in an ontology. In the software development domain, the semantic annotation process is used to tackle problems regarding inappropriate, incomplete, and inconsistent syntactic descriptions of software development artefact properties and qualities. Qiang, Ming and Zhiguang [2] implement a semantic annotation-based software knowledge-sharing space to improve the level of knowledge sharing and facilitate collaborative work among project members. Ontologies are used to create a link between software artefact contents and the abstract knowledge in the space. However, the annotation process is done manually by team members. Zygkostiotis, Dranidis and Kourtesis [3] propose a manual approach to semantically annotate Java source code using domain ontologies for the purpose of software reuse. This approach makes use of the standard annotation facility equipped with the release of Java 5.0 to add metadata to source code elements. In [4], the authors discuss the use of semantic annotations in requirements document templates to support the management and evolution of requirements. The semi-automatic annotation process is based on the conceptualisation captured in the defined software requirement ontology. In [5], the authors propose KnowBench, a semantic-based knowledge management system to assist developers to reuse code or knowledge about solving problems that had been previously addressed in the organisation. The source code is captured by means of both manual and semi-automatic annotation. Damljanovic, Amardeilh and Bontcheva [6] introduce an automatic approach to enhance semantic access to software artefacts (e.g., software document, source code) using the semantic annotation process. This approach is based on the text analysis technique. Tagliatalata and Taglino [7] propose an approach to enrich the semantic description of source code by semantically annotating it with a common domain ontology. The goal is to develop a semantic-based search and retrieval of software artefacts in order to facilitate software reuse. The annotation mechanism is based on the analysis of the source code comments which are added by a developer. The annotation process is automatic. However, the quality of the annotation result depends on the quality of the code comments. Tichy, Köerner and Landhäußer [8] propose an approach to automatically create software models from natural language texts with semantic annotation. In [9], the authors present a concept whereby automated software composition is supported by semantic modelling and making use of the annotation process and semantic extensions through knowledge-based techniques.

In the literature review, a significant amount of research contains proposals for semantically annotating software project-related information. A number of works have contributed to source code semantic annotation. However, most of the reviewed approaches are based on manual and semi-automatic annotation. The manual approaches are considered inappropriate because they are tedious, time consuming, and error-prone, especially when a large volume of software artefacts is generated within a project. The semi-automatic annotation approaches can be a good solution; however, they still require human intervention at some annotation level. Some works have proposed the automatic approach. However, most of them are based on text analysis techniques so that they are applicable only to textual artefacts (e.g., software requirement specification, software documents); they are not suitable for the semantic annotation of certain types of artefacts such as source code. In addition, most of the reviewed works regarding semantic annotation approaches in the software engineering domain focus only on semantic annotation which is intended to create semantic descriptions of software resources. Fewer works have paid attention to populating the ontology which is the task of adding new instances of concepts to the ontology. The new instances could be derived from the semantic annotation.

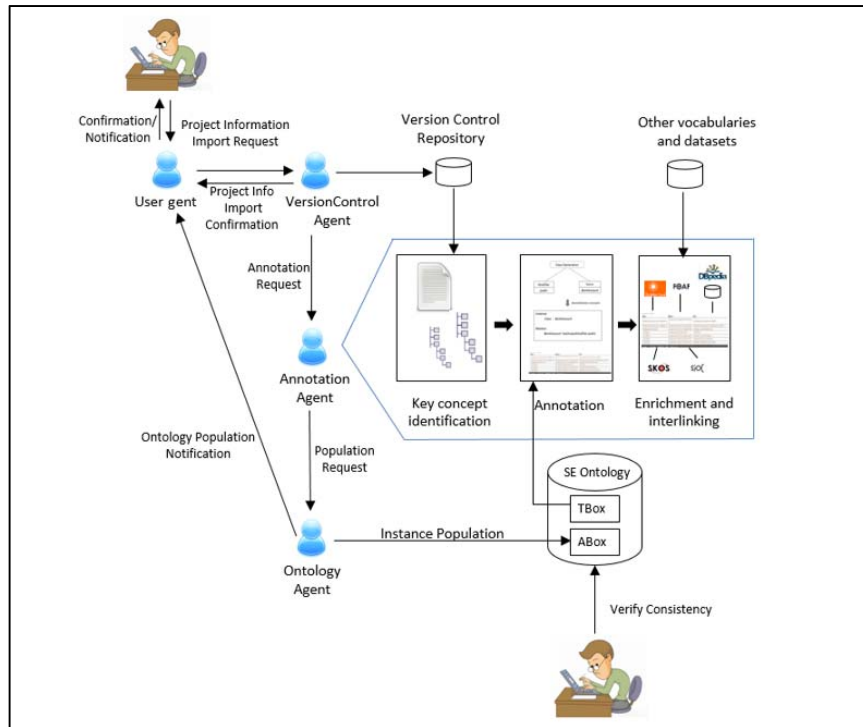
## 2.2. Conceptual framework

Because software development-related information generated within a software project is in syntactic form, its structure is not conducive to an understanding of the semantics, and therefore may create ambiguities (e.g. incorrect or different interpretations). Source code is considered as the main, centrally located artefact and is critical in software development; therefore, the need to capture its semantics in order to facilitate remote communication, coordination and knowledge sharing is obvious. Hence, given the volume of source code that needs to be dealt with, it is imperative to have a systematic approach for automating semantic annotation and ontology population tasks to ease the burden of manual tasks. This approach should be automated, or should require minimum human effort. In this paper, the SEOMAS framework is proposed. The agent annotates software project information according to the corresponding concepts and then generates new instances which are subsequently populated into the ontology repository. The aforementioned processes can be done by software agents with minimum human intervention. In addition, the utilisation of agents can speed up the process because they are able to act in parallel. To sum up, an ontology-based multi-agent approach will encourage team members to share their knowledge by offering automated and transparent support to semantically capture software project information when they are working on software development process. In this work, the Agent Unified Modelling Language (AUML), a standard representation by FIPA to describe agent communication and protocols [10, 11] has been chosen as an appropriate methodology to capture agent concepts and their interactions. The proposed framework is intended to provide active support to assist software team members

with software engineering knowledge when they are working on multi-site distributed software development projects. It comprises four agent types with brief descriptions of their roles as follows.

- **User agent (UA)** is a mediator between a user and the system. A user employs his/her user agent to perform tasks on his/her behalf.
- **VersionControl agent (VA)** is responsible for managing the version control repository. In this research, this agent focuses on the import of new source code file(s) into the version control repository.
- **Annotation agent (AA)** is responsible for annotating software project information that is imported into the version control repository.
- **Ontology agent (OA)** is responsible for accessing and manipulating the SE Ontology domain and instance knowledge. It also manages the ontology population according to the semantic annotation process.

In order to summarise the semantic annotation and the ontology population process performed by the SEOMAS agents as described above, the whole process is shown graphically in Figure 1.



**Figure 1** The automated knowledge capture by the SEOMAS approach

Due to space constraint, it is not practical to describe the complete internal aspect model of all agents. In this paper, the internal model of the annotation agent is chosen to be refined as followed.

The annotation agent is mainly responsible for semantically annotating software project information (i.e., source code artefact). It responds to an annotation request from the versioncontrol agent by carrying out a semantic annotation process in order to identify new instances of the Software Engineering Ontological concepts from the source code artefacts. The role associated with this agent is *SemanticAnnotator*. The *SemanticAnnotator* role is to semantically annotate source code artefacts with the appropriate concepts defined in the SE Ontology. The annotation agent fulfils its role with two main behaviours: *IdentifySourceCodeKeyConcepts* and *AnnotateSourceCode*.

### 2.2.1 IdentifySourceCodeKeyConcepts behaviours

An incoming request for source code annotation from a user agent is managed by the *IdentifySourceCodeKeyConcepts* behaviour. Two main steps are performed after a request has been identified:

- 1) **Source code retrieval**

This step is to retrieve the requested source code file from the version control repository.

- 2) **Key concept identification**

This step is to identify the key concepts that are being used in the source code. The source code is analysed and parsed to produce an abstract syntax tree (AST) which is a representation of the abstract syntactic structure of the source code written in a programming language, for example, classes, fields, methods, constructors, parameters as well as in-line comments (e.g., JavaDoc). For source code comments such as author, versions are also identified and parsed in order to obtain a meaningful term-based description of the source code.

### 2.2.2 AnnotateSourceCode behaviours

After the *IdentifySourceCodeKeyConcepts* behaviour accomplishes its task of key concept identification, the *AnnotateSourceCode* behaviour is initialised as indicated in the pre-condition [*sourcecodeIdentified*]. It annotates the source code elements with the appropriate concepts defined in the SE Ontology and other well-known ontologies and vocabularies, as well as to enrich and to interlink the annotated source code with similar concepts in other datasets (Figure 6-14). This behaviour comprises two main tasks:

#### 1) Source code annotation

The identified source code elements and other software artefacts are assigned software engineering domain concepts that correspond to their semantic description specified in the SE Ontology. Examples of these concepts are Class, Field, Method, Parameter, Modifier, etc. The source code elements that are assigned to those concepts are used to construct statements in the format of RDF/OWL triples which comprise three elements, namely, subject, predicate, and object (subject, predicate, object). The subject part identifies the thing that the statement is about. The predicate part identifies the property or characteristic of the subject that the statement specifies. The object part identifies the value of the property or characteristic [12]. The RDF/OWL statement can be used to semantically describe:

- resource type of the source code elements such as (HelloWorld, type, Class),
- attribute of the source code elements such as (HelloWorld, isMainClass, “True”), or to define the relationship between source code elements such as (HelloWorld, hasMethod, main).

#### 2) Enrichment and Interlinking

Other relevant domain ontologies and controlled vocabularies, namely, FOAF, DC, SKOS, SIOC are reused to enrich and interlink the semantic description of the annotated source code. For example, all the source code elements (e.g., class, package, interface, etc.) are annotated with the relationship *rdf:type* as Dublin Core Metadata Initiative (DCMI) Type ‘*Software*’<sup>1</sup>. If the name of an author is available in the source code, then this relationship is defined in the resulting RDF/OWL triple by using *foaf:name*. The use of existing domain ontologies can enhance the re-useability factor and promote data interoperability [13] as well as help to find semantic similarities with other similar entities described in different semantic repositories. Interlinking also includes the construction of semantic relationships between the annotated source code elements and other entities defined in other dataset on the Web, namely, Wikipedia. In other words, interlinking can enable extensive textual information related to the annotated source code elements or other project-related resources to be retrieved from the Wikipedia website. To extract structured information from Wikipedia and then transform it into RDF, DBpedia has been developed by the research community. The URI according to the format <http://dbpedia.org/resource/Name> corresponds with the URL of the source Wikipedia article, which has the pattern <http://en.wikipedia.org/wiki/Name> [14]. The annotation agent interlinks the annotated source code elements with the corresponding DBpedia entity by using the *owl:sameAs* property. This property is used to specify that the URIs of the annotated elements and those of DBpedia actually refer to the same entities. After the source code has been annotated with the SE Ontology domain concepts as well as enriched and interlinked with other ontologies and controlled vocabularies, the ontology agent inserts the annotated source code into the ontology as new instances.

## 3. Result and discussion

### 3.1. Prototype Implementation and Results

The prototypes are used as proof-of-concept experiments of the proposed framework. Java source code is selected for a proof-of-concept implementation. Jena, a Java framework for building Semantic Web applications, is used to make a connection between agents and the SE Ontology and to provide several functionalities such as create, read, modify triples in RDF/OWL. Qdox is used as a parser for the extraction of source code elements. JADE, Java Agent Development Framework [17], which is an agent middleware, is chosen to implement the agent platform and to provide a development framework. JADE is developed from Java and is completely based on the Foundation for Intelligent Physical Agents (FIPA) specifications [18]. Agent Communication Language (ACL) defined by FIPA is chosen as the language of communication between

agents. JADE provides various implemented FIPA-specified interaction protocols such as FIPA-Query, FIPA-Request and so on to construct agent conversation messages. JADE helps to integrate ontologies to represent the application domain through its content reference model [19]. The SE Ontology is registered to this model through the ontological elements, namely, predicates, concepts, and agent actions so that it can be accessed by JADE agents and used as the content of an ACL message.

The SEOMAS agents populates the SE Ontology by inserting new instances derived from the semantic annotation process into the ontology repository. For example, the Java source code, BankAccount.java<sup>2</sup> is semantically annotated and identified as instances of ClassType (Class), Constructor, and Method. In addition, because the BankAccount instance is enriched with the Software concept of Dublin Core Metadata Initiative (DCMI), so it is an instance of a Software class as well. The annotated source code elements are also enriched by interlinking them with other relevant data source in order to provide an extended view of them. The annotated Java class BankAccount is interlinked with the DBpedia dataset named [http://dbpedia.org/page/Java\\_class\\_file](http://dbpedia.org/page/Java_class_file). The link is created by using an owl:sameAs property to specify that the URI of the annotated element and that of the DBpedia dataset refer to the same resource. As a consequence, additional information about the Java class file can be obtained or queried from DBpedia website (<http://dbpedia.org>). Figure 2 depicts the instances and relationships of class BankAccount populated in the SE Ontology. The graph is generated by the OntoGraf plugin.

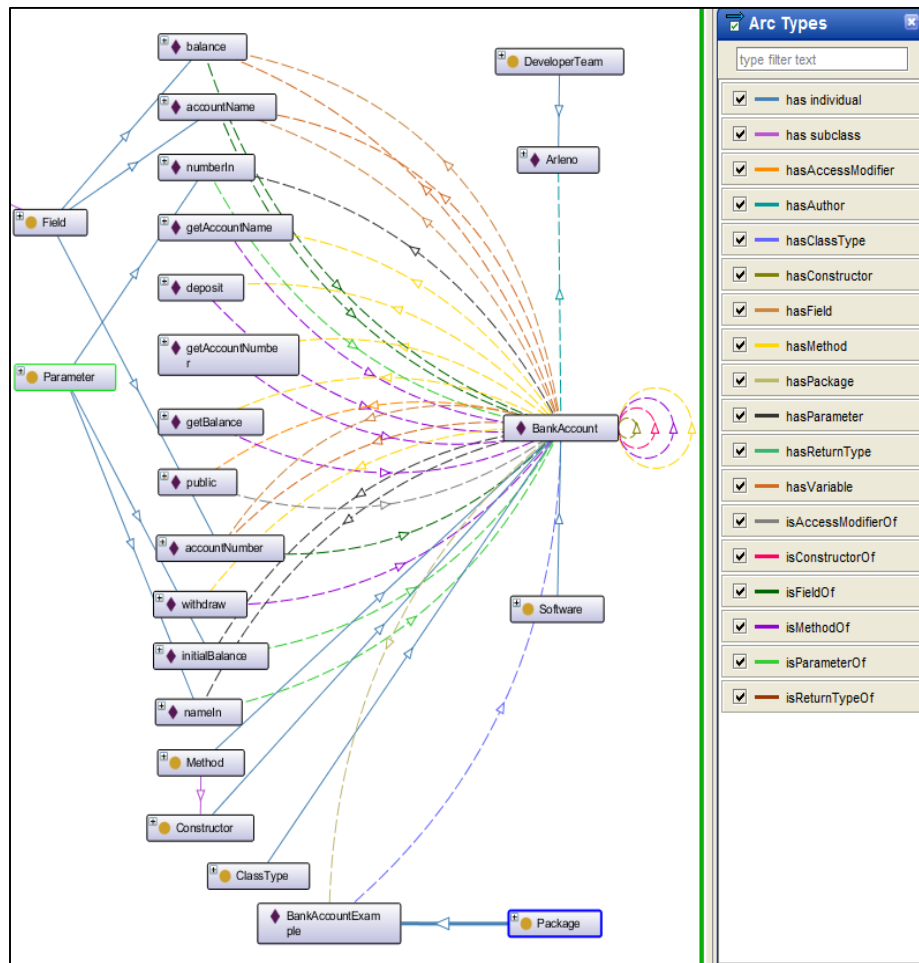


Figure 2 OntoGraf presentation of the BankAccount class instance.

The practical uses of the SEOMAS approach for evaluation purpose are based on a vehicle registration system being developed by a multi-site team located across various sites. Software developers communicate, coordinate, manage and share software development project information captured in the SE Ontology through the collaborative agents during the bug resolution process. The vehicle registration system is being developed in a multi-site software development environment. Software developers are dispersed across four sites, namely, Perth, Bangalore, Dublin, and Shanghai. All the Java classes are annotated and populated in the SE Ontology repository

<sup>2</sup> <http://homepages.uel.ac.uk/A.Kans/pm1/week3.pdf>

by means of the SEOMAS approach. They are also semantically interlinked with other relevant software project information captured in the SE ontology, e.g., project description, project team information, source code commit, bug reports, etc. In other words, software project-related software information will not appear in isolation, but will be part of a large group of related information.

When Alex, a developer, requests a change to the method `getMakeYear` of the `Vehicle` interface by modifying a method return type through the SEOMAS platform, the ontology agent can make him aware of the potential impact to other software components. In object-oriented system development, a subclass is dependent on the super class that it inherits or the interface that it implements; therefore, a change in the super class or the interface will impact on its subclass. Figure 3 presents the recommendation of potentially affected artefacts sent to Alex. `MotorBike` and `Car` class are suggested as affected classes when the `getMakeYear` method is modified because they implement the `Vehicle` interface. `VehicleRegistration` is also suggested as the affected class because it is the main call which invokes either `Car` or `MotorBike` class. Figure 4 illustrates messages sent to notify the authors of those potentially affected artefacts to be aware of the change in the `Vehicle` interface. In this example, the manipulation platform does not only assist team members to manage the software project information captured in the Software Engineering Ontology, but it also provides useful and precise situational knowledge regarding the change impact analysis to improve team members' awareness and alert them to the need for coordination.

```

Output - MultiAgentSystem (run)
--- Message sent to Alex Agent@MASPlatform ---
--Affected Subclasses--
MotorBike implements Vehicle
Car implements Vehicle
--Affected main classes--
VehicleRegistration calls getMakeYear
    
```

Figure 3 Recommendation of potentially affected artefacts

```

Output - MultiAgentSystem (run)
--- Message sent to Arleno Agent@MASPlatform ---
There is a change in getMakeYear of Vehicle class that might affect MotorBike class.
--- Message from RecommenderAgent@MASPlatform ---
--- Message sent to Vishay Agent@MASPlatform ---
There is a change in getMakeYear of Vehicle class that might affect Car class.
--- Message from RecommenderAgent@MASPlatform ---
--- Message sent to Richard Agent@MASPlatform ---
There is a change in getMakeYear of Vehicle class that might affect VehicleRegistration class.
    
```

Figure 4 Messages to notify the authors of potentially affected artefacts

### 3.2. Evaluation

In this section, the evaluation of automated knowledge capture of source code artefacts is demonstrated through the case study derived from [20]. Table 1 describes the bug resolution process mentioned in the case study when the SEOMAS framework is not utilised.

Table 1 Bug resolution process described in [20]

No.	Date	Actor	Actions
1.	3 Aug 2009	Richard@Perth	Richard filed a bug report in the project issue tracking system with high priority.
2.	4 Aug 2009	Richard@Perth	Richard filed another bug report with an urgent request hoping to increase its priority and draw greater attention from developers.
3.	4 Aug 2009	Vishay@Bangalore	Vishay came up with a quick fix and added a comment at the end of the report, putting the report into the status of "re-evaluation pending".
4.	11 Aug 2009	Arleno@Shanghai	Arleno filed a duplicate bug which was soon recognized as a repeated report two days later.
5.	15 Aug 2009	Arleno@Shanghai	Arleno discussed with his team members and supervisor, who added comments to the report and directed their concerns back to the Bangalore Lab
6.	17 Aug 2009	Larry@Bangalore	Larry provided another bug fix solution
7.	17 Aug 2009	Michael@Dublin	Michael picked up the fix and pointed out that Larry's fix might produce deadlocks in another related component and suggested reverting back to the first fix.

No.	Date	Actor	Actions
8.	18 Aug 2009	Larry@ Bangalore	Larry fixed the bug based on Michael's instruction
9.	24 Aug 2009	Michael@ Dublin	Michael checked the fix and marked the bug report status as "resolved" and closed the bug.
10.	24 Aug 2009	Lisa@ Shanghai	Lisa suggested that the latest fix resulted in a connection timeout.
11.	25 Aug 2009	Larry@ Bangalore	Larry asked Lisa to explain the affected component
12.	25 Aug 2009	Michael@ Dublin	Michael fixed the bug, and explained his fix.
13.	29 Aug 2009	Richard@Perth	Richard closed the bug as "resolved".
Total	27 days	6 actors	13 actions

From Table 1, it can be seen that even though the bug was not too complicated and needed only a simple modification to fix the problem, it took 27 days to finalise the resolution which might cause a project delay. Difficulties arose from the lack of common semantics. First, the information related to the bug was dispersed among several software repositories with no links to indicate that they were related to each other. Therefore, the same bug report was filed repeatedly. Second, the bug was initially fixed by developers who had no expertise in this area, resulting in several iterations of invalid fixes. Without the knowledge support to match the bug with the expert, the bug-fixing time could be prolonged. Finally, the inadequate sharing of project information and knowledge, such as the dependencies among software components, can delay the bug fixing. As discussed above, Larry did not know what the affected component was, so he needed someone to clarify this information because there was no available and explicit reference that he could access.

In order to address the abovementioned issues, software project information (e.g., source code, bug reports, communication threads) should be captured so that software development knowledge becomes conceptualised, organised, and can be semantically linked among related knowledge. The SEOMAS framework can help to automate knowledge capture process by means of the semantic annotation and the ontology population tasks which are seamlessly integrated into the software development process (e.g., version control). Once this software project information has been captured and integrated, it is available for sharing among software project teams to facilitate software development activities or to address project issues by, for example, assisting with a bug resolution process as described in Table 2.

**Table 2** Bug resolution process with supporting from the SEOMAS approach

No.	Date	Actor	Actor Actions	Agent	Agent Actions
1.				VersionControl agent  Annotation agent  Ontology agent	1. The versioncontrol agent imported a new software project information file into the version control repository. 2. The annotation agent annotated software development artefacts to identify new instances. 3. The ontology agent populated the SE Ontology with new instances.
2.	3 Aug 2009	Richard@ Perth	Before filing a bug report, Richard checked whether the bug had been reported through the query platform	Richard's user agent	Richard's user agent sent a query request to the ontology agent
3.	3 Aug 2009			Ontology agent	The ontology agent retrieved existing bug reports related to the problem class and sent them back to the user agent.
4.	3 Aug 2009	Richard@ Perth	Richard filed a new bug report with high priority.		
5.	3 Aug 2009			Ontology agent	The ontology agent 1. identified Michael@ Dublin as the most likely person to be able to solve the new filed bug report; 2. attached Michael@

No.	Date	Actor	Actor Actions	Agent	Agent Actions
					Dublin as the potential fixer into the bug report; 3. sent a message to notify Michael@Dublin to draw his attention to the new bug report that may need his expertise to resolve.
6.	3 Aug 2009	Michael@Dublin	Michael received a message to notify him of a new bug report.	Michael's user agent	Michael's user agent translates a message from the ontology agent and display to Michael
7.	3 Aug 2009			Ontology agent	The ontology agent provided Michael with: 1. information about the problem class and its related software components; and 2. history of all previous bugs reported to the problem class and how they were fixed.
8.	4 Aug 2009	Michael@Dublin	1. Michael fixed the bug based on information from the ontology agent. 2. Michael marked the bug report status as "resolved".		
9.	4 Aug 2009			Ontology agent	The ontology agent sent a message to notify Richard that the status of the bug had been changed to "resolved".
10.	5 Aug 2009	Richard@Perth	Richard read the message, verified the resolution, and then closed the bug.		
Total	3 days	2 actors	6 actions by real user	6 agents	12 actions by agents
Total number of actions			18 actions		

As demonstrated in Table 2, the bug resolution process involves bug understanding, bug triage, and bug fixing as well as additional steps to avoid the recurrence of similar bugs in the future. It is considered as one of the most complex activities particularly in a multi-site distributed software development project because it requires significant collaboration of information from various sources (e.g. bug reports, software components, forum discussions) and various stakeholders. From the comparison provided in Table 1 and Table 2, it is evident that the SEOMAS framework can help multi-site distributed software development teams to resolve the bug issues by improving the effectiveness and the efficiency of communication and coordination as well as enabling knowledge sharing as follows.

1. Before filing a bug report, the ontology agent can help a software developer to locate related bug reports based on their associated concepts defined in the SE Ontology and its instances. Then s/he can view a list of existing bugs reported to a particular class and determine whether the current bug is a duplicate. In this case, duplicated bug reports could be identified early and avoided. This can reduce the unnecessary information overload and considerably reduce confusion as well as help to prevent tedious conflict.

2. After a bug has been filed, the ontology agent can recommend a person who is most likely able to resolve the bug issue, and sends a message to alert him about the new bug report that potentially needs his expertise to resolve. This can help to match a bug to a potential fixer or consultant to avoid the inadequate fixes from someone without expertise with this particular bug.

3. When the bug is being fixed, the ontology agent can provide relevant information that is necessary for fixing the bug such as the history of bugs reported to the problem class and their resolution, or related software components and their owners. Then the developer can know what dependencies exist and check with relevant people before making a change to prevent unintended side effects from a change made.

4. When a developer makes a change to the source code, he is also proactively informed about the components that potentially may be affected by a change. This can reduce unintended side effects from the impact of the bug fixing, and avoid future problems.

5. The ontology agent sends a message to notify the bug reporter as soon as the bug status is changed to "resolved". The reporter then knows that the issue that he reported has been resolved, so he can verify the

solution. Once he is satisfied with the solution, the bug report can be closed. The SEOMAS agents can improve real-time awareness of team members and enable efficient coordination without overloading them.

### **Parameters for Efficiency Measurement**

In the above scenarios, the efficiency of bug resolution by utilising the SEOMAS framework is measured by three parameters, namely, time to complete the task, the number of team members involving in the bug resolution, and the number of team members' actions.

1. Time to complete the task

Without the support of SEOMAS, the estimated time that would be taken to resolve a single bug issue is 27 days. However, when SEOMAS is utilised, it takes only three days to fix the same bug. This significant reduction in time is due to the fact that source code artefacts and other software-related project information (e.g., bug reports, archived communications) are all captured and can be integrated to generate interconnections among them. The ontology agent can utilise this interlinked knowledge space to deliver useful and timely information to development teams. The delivered information is also based on previous historical data in the software project. Information such as a match between a bug and expert, related software components and related bugs, can assist developers to diagnose and fix the bug more effectively and efficiently. Therefore, the response time required to correct failures to complete the bug resolution task is reduced.

2. The number of team members involving in the bug resolution

As seen in Table 1, six team members are involved in the bug resolution process. Even though the bug is not a complicated one and may require only a simple modification by an expert, without utilising the SEOMAS platform, it goes around across multiple sites which leads to several iterations of inappropriate fixes from someone without expertise in fixing this kind of bug; moreover it unnecessarily prolongs the bug resolution process. With the support from the SEOMAS framework, fewer team members are involved in the bug resolution process because the number of people reporting duplicate bugs can be reduced and the bug can be directly assigned to the appropriate team member who has the expertise required to resolve the issue instead of going around to several people.

3. The number of team members' actions

In the bug resolution scenario without support from the SEOMAS framework, it can be seen that there are a number of unnecessary actions from the team members. For example, personnel are filing duplicated bugs or iteratively fixing the same bug. This is because the information and interactions which relate to the bug are stored in various software artefacts without links between them. When the SEOMAS platform is utilised, the source code is annotated using meta-data that is semantically rich to enable it to be interlinked with other relevant information. Hence, the development artefacts are all related, not independent. Therefore, the ontology agent can help to locate related problems and deliver them to the team members to prevent the same bugs from being reported multiple times. Therefore, the number of team members' actions is decreased from thirteen actions to six actions.

From Table 2, it can be seen that the total number of actions with SEOMAS support is higher than without the SEOMAS support in Table 1. This is because several actions are performed by the SEOMAS agents to achieve their goal and to enable team members to perform their tasks more efficiently. These actions include the translation between team members and their user agents, identifying expert and recommending useful information about related software components, sending messages sent to relevant team members. However, these actions are autonomously performed by the agents and do not impact on team members' performance.

### **4. Conclusions and Future work**

In this paper, the SEOMAS framework for semantic annotation to automate knowledge capture of source code artefacts is proposed. The agents utilise the SE Ontology to capture knowledge from software development artefacts during the daily software development activity. The captured knowledge is populated as new instances in the SE Ontology repository to allow project team members and software agents to access it. In the future, the SEOMAS framework can be extended to capture the semantics of other types of software artefacts. The extension can cover the semantic annotation of both structured information (e.g., UML diagrams, issue tracking, commit data) and unstructured information (e.g., requirement documents, bug reports, forum discussion).



## References

- [1] D. E. Forbes, A Framework for Assistive Communications Technology in Cross-Cultural Healthcare. School of Information Systems, Curtin Business School, Curtin University, 2013.
- [2] L. Qiang, C. Ming, and W. Zhiguang. A semantic annotation based software knowledges sharing space. **Network and Parallel Computing**, 2008. NPC 2008. IFIP International Conference on, doi: 10.1109/npc.2008.55.
- [3] Z. Zytkostiotis, D. Dranidis, and D. Kourtesis. Semantic annotation, publication, and discovery of Java software components: an integrated approach. In Proceedings of the 2nd Workshop on Artificial Intelligence Techniques in Software Engineering (AISEW 2009), Thessaloniki, Greece: CEUR-WS.org. 168-178.
- [4] L. d. O. Arantes, and R. d. A. Falbo. An infrastructure for managing semantic documents. In Enterprise Distributed Object Computing Conference Workshops (EDOCW), 2010 14th IEEE International, October 25-29, 2010; 235-244. IEEE.
- [5] D. Panagiotou, and G. Mentzas, Leveraging software reuse with knowledge management in software development. **International Journal of Software Engineering and Knowledge Engineering**. 2011; 21(5):693-723; 2011.
- [6] D. Damljanovic, F. Amardeilh, and K. Bontcheva, CA manager framework: creating customised workflows for ontology population and semantic annotation. In Proceedings of the Fifth International Conference on Knowledge Capture, Redondo Beach, California, USA, 2009, 177-178.
- [7] A. Tagliatalata, and F. Taglino, A semantics-based approach to software reuse. In the Fifth Interop-Vlab.It Workshop on Complexity of Systems, Complexity of Interoperability in conjunction with itAIS 2012., Rome, Italy.
- [8] W. F. Tichy, S. J. Köerner, and M. Landhäußer. Creating software models with semantic annotation. In Proceedings of the Third Workshop on Exploiting Semantic Annotations in Information Retrieval, Toronto, ON, Canada, 2010; 17-18.
- [9] P. Graubmann, and M. Roshchin. Semantic annotation of software components. In Software Engineering and Advanced Applications, 2006. SEAA '06. 32nd EUROMICRO Conference on, 2006; 46-53.
- [10] M.-P. Huget, and J. Odell. Representing agent interaction protocols with agent UML. Agent-Oriented Software Engineering V: 5th International Workshop, AOSE 2004, New York, NY, USA, July 19, 2004. Revised Selected Papers, J. Odell, P. Giorgini and J. P. Müller, eds., pp. 16-30, Berlin, Heidelberg: Springer Berlin Heidelberg, 2005.
- [11] M.-P. Huget, J. Odell, and B. Bauer. The AUML approach. **Methodologies and Software Engineering for Agent Systems: The Agent-Oriented Software Engineering Handbook**, F. Bergenti, M.-P. Gleizes and F. Zambonelli, eds., 237-257, Boston, MA: Springer US, 2004.
- [12] D. Beckett, and B. McBride. RDF/XML syntax specification (revised). **W3C recommendation**. 2004; 10.
- [13] J. Ashraf, O. K. Hussain, and F. K. Hussain. A Framework for Measuring Ontology Usage on the Web. **The Computer Journal**. 2012.
- [14] C. Bizer, J. Lehmann, G. Kobilarov, S. Auer, C. Becker, R. Cyganiak, and S. Hellmann. DBpedia - A crystallization point for the Web of Data. **Web Semantics: Science, Services and Agents on the World Wide Web**. 2009;7(3): 154-165.
- [15] M. Robillard, R. Walker, and T. Zimmermann. Recommendation systems for software engineering. **Software, IEEE**. 2010; 27(4): 80-86.
- [16] "QDox," October 11, 2014; <http://qdox.codehaus.org>.
- [17] Y. Liao, M. Lezoche, H. Panetto, and N. Boudjlida. Semantic annotation model definition for systems interoperability. On the Move to Meaningful Internet Systems: OTM 2011 Workshops. 2011; 61-70.
- [18] F. L. Bellifemine, G. Caire, and D. Greenwood. **Developing multi-agent systems with JADE**: John Wiley & Sons; 2007.
- [19] G. Caire, and D. Cabanillas. Jade tutorial application – Defined content languages and ontologies.12 July 2016; <http://jade.tilab.com/doc/tutorials/CLOntoSupport.pdf>.
- [20] P. Wongthongtham, T. Dillon, and E. Chang. State of the Art of Community-Driven SE Ontology Evolution. In Proceedings of Dependable, Autonomic and Secure Computing (DASC), 2011 IEEE Ninth International Conference on, doi: 10.1109/DASC.2011.170.

# **Session of Medical Health Sciences and Laws**

# Stress Relieving of Thai Traditional Medicine Students by using Thai Traditional Medicine

Pitchayapa Attanoruk<sup>1,\*</sup>, Pitchayapha Inphrom<sup>1</sup>, Jatuporn Panusnothai<sup>1</sup>,  
Nantiya Manhmay<sup>1</sup>, Sittipong Pornprasit<sup>1</sup>

<sup>1</sup>Thai Traditional Medicine Program, Faculty of Science and Technology,  
Bansomdejchaopraya Rajabhat University, Bangkok, Thailand

## Abstract

The objective was to decrease stress level in Thai Traditional Medicine students of Bansomdejchaopraya Rajabhat University. Study design was Pretest-posttest and one week follow up one group design. The Thai traditional relaxation activities (Thai Hermit Exercise, Thai self-massage and psychotherapy art meditation) were implemented and 61 respondents to the questionnaires (ST5). Descriptive Statistics, t-test at 95% CI were using for data analysis.

The research results revealed that the most of Thai Traditional Medicine students before implement have moderate stress (5-7 scores) 37.8 percent, the most of Thai Traditional Medicine students after implement have less stress (0-4 scores) 47.5 percent, The stress level was decreased ( $p$ -value < 0.001). When follow up after implement 1 week the stress level in Thai Traditional Medicine students was decreased ( $p$ -value < 0.001). Developing ideas and methods for continuing organize this activity and expand the results to other agencies were recommended.

**Keywords:** Stress relieving, Student, Thai Traditional Medicine

## 1. Introduction

Stress is the mental imbalance. It can occur with all groups of people regardless of their genders; ages or occupations. Each individual will experience different levels of stress, which largely depended on his or her lifestyles. Nowadays technology is rapidly advancing, the lifestyle of urban people is always in a hurry with greater competition and the shortage of resting. The absence of relaxation caused the accumulation of stress which might result in the mental illness.

The study with higher education participants by Nitipun Boonpume [1] indicated that the students required to improve their perceptions as well as to be suitably adaptive toward their learning life which changes constantly occurred and thus affected the individual's stress. These changes including the orientation; adjustment to the learning style of the university; change in the dwelling; entering the new society; preparation for the career life and family life. Furthermore, the environment surrounding a student including the economy; family; and colleagues as well as his or her personal relationship; expectations toward himself or herself; family and others. These may be considered as the supplemental factors causing the stress in students.

Suwanna Sisomprasong [2] has identified the causes associated with the medical students' stress include that learning; Academy's regulations; colleagues; lecturers and medical personnel; causes relating with the future; time allocation; and their responsibilities as mature individuals.

Khanuengnut Thumpharak, *et. al.* [3] reported that the students who were unable to cope with these problems are likely to experience the mental anxiety and frustration. These problems have affected the learning performances and the living of students which they have been planning and resulted in frequent stress.

S Mohapatra, *et. al.* [4] said that the extremely high prevalence of mental health problems in university students provides evidence for this being an at-risk population. The results highlight the need for universal early interventions to prevent the development of severe mental illness in university students.

Emma Warnecke, *et. al.* [5] concluded that mindfulness practice reduced stress and anxiety in senior medical students. Stress is prevalent in medical students and can have adverse effects on both student health and patients

---

\* Corresponding author; e-mail: amjoke51@gmail.com

Therefore, the author has interested in the stress relieving approach using the principles of Thai traditional medicine and applying the results to improve the procedures in various aspects for the prevention of stress problems among the students and shall implement the preliminary results as the advice for the students.

## 2. Objectives

To compare Pretest-posttest and one week follow-up the stress' Thai traditional medicine undergraduate student of Bansomdejchaopraya Rajabhat University by using the Thai traditional relaxation activities (Thai Hermit Exercise, Thai self-massage, psychotherapy art meditation)

## 3. Methods

3.1 The study was the action research with the one group pretest - posttest and one week follow up. The participants were the Thai traditional medicine undergraduate students, Faculty of Science and Technology, Bansomdejchaopraya Rajabhat University

3.2 The research instrument was three stress relieving activities consisting of;

1) 15 steps of Thai Hermit Exercise training. These steps were modified from the Digital Version of 15 steps Thai Traditional Exercise published by the Thai Traditional Medicine institution, Department of Thai Traditional and Alternative Medicine, Ministry of Public Health [6].

2) Self - training Thai massage for stress relieving has been modified from the "the art of self-massage 41 postures" (41 arts of massage styles for healthy life) by the public health and development foundation[7]

3) The psychotherapy art meditation training by the expert lecturer.

The instruments used for collecting data was the stress appraisal and analytic modified from ST5 of the Department of Mental Health. This questionnaire composing with five items (closed questions) and four scale points for each item. Each level of the measurement scale is determined as follows;

Almost no stress	= 0
Occasionally stress	= 1
Regularly stress	= 2
Always stress	= 3

These scales have been verified and amended according to the expert's suggestion. The calculated reliability using the Cronbach's Coefficient Alpha was 0.764

The scores from the questionnaires of all applicants have been combined together and analyzed using the frequency distribution and percentage calculation and compared to the score interpretation criterion specified by the Bureau of Mental Health Development, Department of Mental Health, Ministry of Public Health as shown as follows;

0-4 scores	= low stress
5-7 scores	= moderate stress
8-9 scores	= high stress
10-15 scores	= maximum stress

The general data were analyzed using descriptive statistics. Data distribution testing by using Kolmogorov-Smirnov Test (K-S Test). The comparison of students' stress scores pretest - posttest and posttest – follow up 1 week have been performed using t-test with 95% confidence interval.

## 4. Results and discussion

In this study, there were 61 participants, consisting of 53 females (87%), 8 males (13%). Of this, 28 students (46%) are from the 1st year, 23 students (38%) from the 2nd year, 7 students (11%) from the 3rd year and 3 students (5%) from the 4th year.

Before the participation in the activity, the most of the students have moderate stress (5-7 scores) which accounted for 37.8% as described in Table 1.

**Table 1** The quantities of students categorized by the level of stress prior to the participation in the activity

Indication	Quantities	Percentage
0-4 scores (low stress)	6	9.8
5-7 scores (moderate stress)	23	37.8
8-9 scores (high stress)	19	31.1
10-15 scores (maximum stress)	13	21.3

After participating in the activity, the students were requested to make the stress appraisal again. It has been found that the most of students have low stress (0 - 4 scores), accounted for 47.5% as described in Table 2.

**Table 2** The quantities of students categorized by the level of stress after the participation in the activity

Indication	Quantities	Percentage
0-4 scores (low stress)	29	47.5
5-7 scores (moderate stress)	25	41.0
8-9 scores (high stress)	3	4.9
10-15 scores (maximum stress)	4	6.5

From the monitoring of results for the next following week after the participation in the activity, the students were requested to make the stress appraisal again. It has been found that the most of students have low stress (0 - 4 scores), accounted for 59.0% as described in Table 3.

**Table 3** The quantities of students categorized by the level of stress a week after the participation in the activity

Indication	Quantities	Percentage
0-4 scores (low stress)	36	59.0
5-7 scores (moderate stress)	23	37.7
8-9 scores (high stress)	2	3.3
10-15 scores (maximum stress)	0	0

Data distribution testing by using Kolmogorov-Smirnov Test (K-S Test) found that the scores (before the Participation  $p$ -value at 0.978, After the participation  $p$ -value at 1.119, and One week follow-up  $p$ -value at 1.103) were normal Distribution ( $p$ -value > 0.05)

The comparison of student's stress levels prior and after the participation in the activity revealed that the average stress levels have been diminished with the statistical significance ( $p$ -value < 0.001) as described in Table 4.

**Table 4** Comparison of students' stress scores prior and after the participation in the stress relieve activity using t-test with 95% CI (n=61)

Groups of participating students	Mean	S.D.	$p$ -value
Before the participation	7.59	0.33	<0.001
After the participation	4.56	0.34	

The comparison of student's stress levels after the participation and one-week follow-up has revealed that the average stress levels have been diminished with the statistical significance ( $p$ -value < 0.001) as described in Table 5

**Table 5** Comparison of students' stress scores after the participation and one-week follow-up using t-test with 95% CI (n=61)

Groups of participating students	Mean	S.D.	$p$ -value
After the participation	4.56	0.34	<0.001
One week follow-up	4.05	0.22	

The most of traditional Thai medicine undergraduate students of the academic year 2016 has moderate stress (5-7 scores) before the participation in the activity. This indicated that the participants are disturbed with unresolved anxiety which required a certain amount of times in making the adjustment or copes with the problems which is consistent with the findings of Helen M Stallman [8] which is excessive stress and poor coping skills can put university students at risk for mental health problems. They should be provided with advice or suggestions regarding the stress relieving to unravel the causes of problem consistent with the findings of Department of Mental Health [9] which is in accordance with the stress relieving activity using the Thai traditional medicine to lessen down the students' stress level that resulted in the overall diminishment with the statistical significance (p-value <0.001).

After the students have been participated in the stress relieving activity, the scores from the ST5 appraisal were compared to identify the stress levels before and after the participation. It has been found that the stress scores have been decreased with statistical significance (p-value < 0.001). This indicated that the stress relieving activity is effective and able to practically lessen down the students' stress level is consistent with the findings of Sasithorn Charoenwoodhipong [10] which reported the efficiency of stress relieving program that resulted in the overall decreased stress level of the volunteers with the statistical significance (p-value < .01) and Cheryl Regeh, *et.al* [11] which reported cognitive, behavioral, and mindfulness interventions are effective in reducing stress in university students.

The follow up of the implementation of stress relieving approaches after one week of the participation in the activity revealed that the students are able to constantly implement the stress relieving approaches. Each of the students will adopt the stress relieving methods learned from the activity and applied to their own personalities which has lessen down the level of stress with statistical significance (p-value < 0.001) as shown in Table 5. The result is consistent with Sunisa Tasai, *et.al* [12] which reported that the most of students have appropriate coping methods with the stress and Kuem Sun Han [13] suggests that self-efficacy and health promoting behaviors are significant influencing factors on symptoms of stress among university students.

## 5. Conclusions

The stress relieving activity was an effective and able to practically lessen down the students' stress level respective maximum and high score. Suggestions for further work as shown as follows;

- 5.1 More stress relieving activities should be provided with various methods.
- 5.2 This kind of activity should be provided at least once a year for stress relieving and establishing the relationships between the students of different years.
- 5.3 The stress relieving activities should be provided to other organizations.

## Acknowledgements

The authors wish to thank students of Thai traditional medicine program, Bansomdejchaopraya Rajabhat University and all staffs members for necessary assistance and instrument supports

## References

- [1] Nitipun Boonpume. Stress and coping of Thai traditional medicine students of Rajamangala University of Technology Thanyaburi [dissertation]. Bangkok, Thailand: Silpakorn University; 2010.
- [2] Suwanna Sisomprasong. A Stress of the Fourth-Year to the Sixth-Year Medical Students. Independent Study in Psychology Guidande [dissertation]. Bangkok, Thailand: Srinakharinwirot University; 2009.
- [3] Khanuengnut Thumpharak et.al. A Stress of the First-Year students of Suranaree University of Technology [dissertation]. Nakhon Ratchasima, Thailand: Suranaree University of Technology; 2007.
- [4] S Mohapatra , et. al. Medical student perceptions of academic stress and satisfaction with the revised curriculum quality at iau saudi Arabia. *International Journal for Quality in Health Care*. 2017; 29 (1): 43.
- [5] Emma Warnecke, et. al. A randomised controlled trial of the effects of mindfulness practice on medical student stress levels. *Journal of Medical Education*. 2011; 45 (4): 381–388.
- [6] The Institute of Thai Traditional Medicine, Department of Thai Traditional and Alternative Medicine, Ministry of Public Health. Hermit Thai Yoga Exercises [Video file]. Nonthaburi Thailand; 2009 [cite 8 May 2017]. Available from: <https://www.youtube.com/watch?v=s2if1Lp2jmU>
- [7] Public Health and Development Foundation. the art of self-massage 41 postures. Bangkok: Public Health and Development Foundation; 2005.
- [8] Helen M Stallman. The University Stress Scale: Measuring Domains and Extent of Stress in University Students. *Journal of Australian Psychologist*. 2016; 11 (2): 128-134.
- [9] Department of Mental Health, Ministry of Public Health. Guidelines for using mental health tools for community health workers. (Chronic Disease Clinic). Nonthaburi: Mental Health Publishing House; 2015.

- [10] Sasithorn Charoenwoodhipong. The Effect of Stress Management Program on Stress Levels of Nursing Instructors, Staff Members and Nursing Students. *Journal of Public Health Nursing*. 2011; 25 (1): 46-60.
- [11] Cheryl Regeh, et.al. Interventions to reduce stress in university students: A review and meta-analysis. *Journal of Affective Disorders*. 2013; 148 (1): 1-11.
- [12] Sunisa Tasai et.al. Stress and stress coping of the high school students in Changwat Songkhla. *Journal of Education, Prince of Songkla University Pattani Campus*. 2008; 19 (2): 101-114.
- [13] Kuem Sun Han. Self-Efficacy, Health Promoting Behaviors, and Symptoms of Stress among University Students. *Journal of Korean Academy of Nursing*. 2005; 35 (3): 585-592.



# Factors Related to Mosquito-Borne Diseases in China-Laos Border Areas: Results from Multiple Correspondence Analysis

Chao Wu<sup>1,2</sup>, Hongning Zhou<sup>1</sup>, Jun Zhao<sup>2,3</sup>, Xiaofang Guo<sup>1</sup>, Quan Lv<sup>1</sup>, Hongbin Li<sup>4</sup>,  
Edward B McNeil<sup>2</sup> and Virasakdi Chongsuvivatwong<sup>2,\*</sup>

<sup>1</sup>Yunnan Institute of Parasitic Diseases, Puer, Yunnan, P.R.China

<sup>2</sup>Epidemiology Unit, Faculty of Medicine, Prince of Songkla University, Hat Yai, Songkhla, Thailand

<sup>3</sup>Hubei University of Medicine, Shiyan, Hubei, P.R.China

<sup>4</sup>Xishuangbanna Prefecture Center of Disease prevention and Control, Jinghong, Yunnan, P.R.China

## Abstract

**Background:** In China-Lao border areas of Yunnan province, mosquito-borne diseases are most common. The objective of the study was to group several risk factors related to mosquito-borne diseases.

**Methods:** A survey was conducted in 12 randomly selected villages and eight schools. A structured questionnaire on behaviors and environment variables related to mosquito-borne diseases and demographics was devised.

**Results:** 1295 participants were recruited. Twenty variables on risk behaviors related to mosquito-borne diseases were put into multiple correspondence analysis (MCA). Ten variables contributed in three pertinent dimensions: 1) pig rearing environment, 2) bed-net using behaviors and 3) repellent using behaviors.

**Conclusion:** The control programme should focus on these three groups of risk factors as they significantly explain several items of variables under the investigation.

**Keywords:** behaviors, mosquito-borne diseases, bed-net, repellent, pig rearing, multiple correspondence analysis

## 1. Introduction

Mosquito-borne diseases are increasing a serious global health concern, including-malaria, dengue, ZIKV, Japanese encephalitis, Banna virus fever, chikungunya fever, yellow fever etc. [1]. Yunnan Province, China, located at the southwest border of mainland China with an area of 394,000 km<sup>2</sup> shares international borders with Myanmar, Vietnam, and Laos. The region favors the spread of these diseases. From 2008 to 2016, more dengue outbreaks were reported in this area. [2, 3].

Multiple correspondence analysis (MCA) is a data analysis technique for nominal categorical data, used to detect and represent underlying structures in a data set. It does this by representing data as points in a low-dimensional Euclidean space [4-6]. This fits well with our questionnaires.

In behaviors survey, most of questions are binary (yes vs no). As there are many questions, it is important to group into dimension. Exploratory factor analysis (EFA) is not appropriate because it assumes normality of the item variables.

## 2. Objective

The objective of the study was to group behaviors related to mosquito-borne diseases using MCA and to explore the nature of risk factors related to mosquito-borne diseases. The information from this study would be used in planning of various mosquito-borne diseases prevention and control in this area.

## 3. Methods

### Ethical consideration

Ethical approval was obtained from Institution Ethical Review Committee of Prince of Songkla University on 2 November, 2016 (project code REC 59-244-18-5) and that of Yunnan institute of Parasitic Diseases (YIPD). Informed consent was obtained from all subjects and related authority including guardians of subjects under 16 years of age.

---

\* Corresponding author; email: cvirasak@gmail.com

### Study site and study design

The research was conducted in Mengla County, Xishuangbanna Prefecture, Yunnan Province, which holds a 677.8 km border with Laos. A cross-sectional survey was performed among the selected study sites from 12 to 30 September 2016.

### Sampling technique

The sample was drawn by using two-stage cluster sampling technique probability proportional to size.

### Study participants

In each cluster, participants were randomly recruited from the list of adults in village or list of 6- 18 years old students in the selected schools. Inclusion criteria included being a resident of the study village for more than 6 months.

### Questionnaire and measures

A structured questionnaire was developed to get the information from each participant and piloted in a village and a school, not included in the main study before being used in the field. We developed the same questionnaire for adults and children for the reasons of comparability and possible data pooling in the analysis. Collected data had 4 sections: 1) social-demographics variables such as age, gender, ethnicity, education level, occupation, 2) environmental variables such as pig rearing by family, distance from house to pig farm, with pig farm near the house, distance of the nearest pig farm, with paddy field, near to the forest, with rubber planting, with wasted tires, with aquatic plants, with Pickled jars, with running water and with tanks for water storage, 3) behavioral bed-net using including possess bed-net, often use bed-net, and sleeping in bed-net in daytime, 4) behavioral insect repellent using including using mosquito coil, floral water , and DEET (diethyltoluamide)working or activities outside the house.

### Data management and analysis

Data were recorded by using EpiData (version 3.1). All analysis was performed using R (version 3.4.0). Most of variables in the current study were categorical factors. Multiple correspondence analysis (MCA) was used to display relationships among the individual variables and structural factors using the “FactoMineR” package [5, 6]. The scores of each dimension were extracted and dichotomized as below factor mean (low score for that dimension) and high score otherwise.

### Sample size calculation

To estimate the prevalence of a risk behavior we assume 50% prevalence, with 95% confidence interval of the prevalence deviated 6% from the estimate and a design effect of 2, the sample size required for each age group was 534. In practice, we more than doubled this sample size to allow for other variables with smaller prevalence.

## 4. Results and discussion

### 4.1 Results

A total of 1295 participants were included the study. They came from 5 towns and 20 clusters (8 schools contributing 730 students and 12 villages contributing 565 adults. Table 1 showed the different distribution among the Social-demographic factors. Children group occupied 56.4%. On ethnicity, ethnic Yi group was the biggest group (23.2%), and Han group was the smallest group (11.4%). The majority occupation was student (56%).

Table1 Social-demographic characteristics Social-demographic factors	Social-	Frequency	Percent
<b>Gender</b>			
Male		582	44.9
Female		713	55.1
<b>Age group</b>			
<= 18 year-old		730	56.4
>18 Year-old		565	43.6
<b>Education level</b>			
less than primary school		228	17.6
Primary school		535	42.3

Secondary school or above	532	41.1
<b>Ethnicity</b>		
Han	148	11.4
Dai	187	14.4
Aini	227	17.5
Yi	301	23.2
Yao	256	19.8
Other	176	13.6
<b>Occupation</b>		
Farmer	461	35.6
Student	725	56.0
Other	109	8.4

**Table 2 Levels of correlation (R<sup>2</sup>) between the item variables and the underlying dimension**

Variables items	Abbreviation	Dimension 1	Dimension 2	Dimension 3
R <sup>2</sup>				
Pig rearing by family	pr	0.505	0.001	0.221
Distance from house to pig farm	ds	0.505	0.057	0.23
With pig farm near the house	wpfh	0.525	0.041	0.075
Distance of the nearest pig farm	dsh	0.542	0.078	0.084
Housing structure	hs	0.006	0.184	0.058
Paddy field	pf	0.001	0.032	0.009
Near to the forest	nf	0	0.036	0.005
Rubber planting	wrp	0	0.125	0.019
Discarded tires	d	0.007	0.024	0.01
Aquatic plants	wap	0.012	0.018	0.012
Pickle jars	wpc	0.045	0	0.003
Running water	rw	0.003	0	0
Tanks for water storage	tk	0.007	0.051	0.004
Family possess bed-net	fpbn	0.001	0.588	0.017
Using bed-net	ubdn	0	0.671	0.01
Sleeping in bed-net on daytime	sbn	0.003	0.54	0.011
Using insect repellent	urwo	0.35	0.02	0.525
working outside				
Using mosquito coils	umc	0.331	0.016	0.472
Using floral water	utw	0.16	0.04	0.363
working/playing outside				
Using DEET	ude	0.065	0.031	0.017

working/playing  
outside

**(R2 the squared correlation between each categorical variable and the dimensions)**

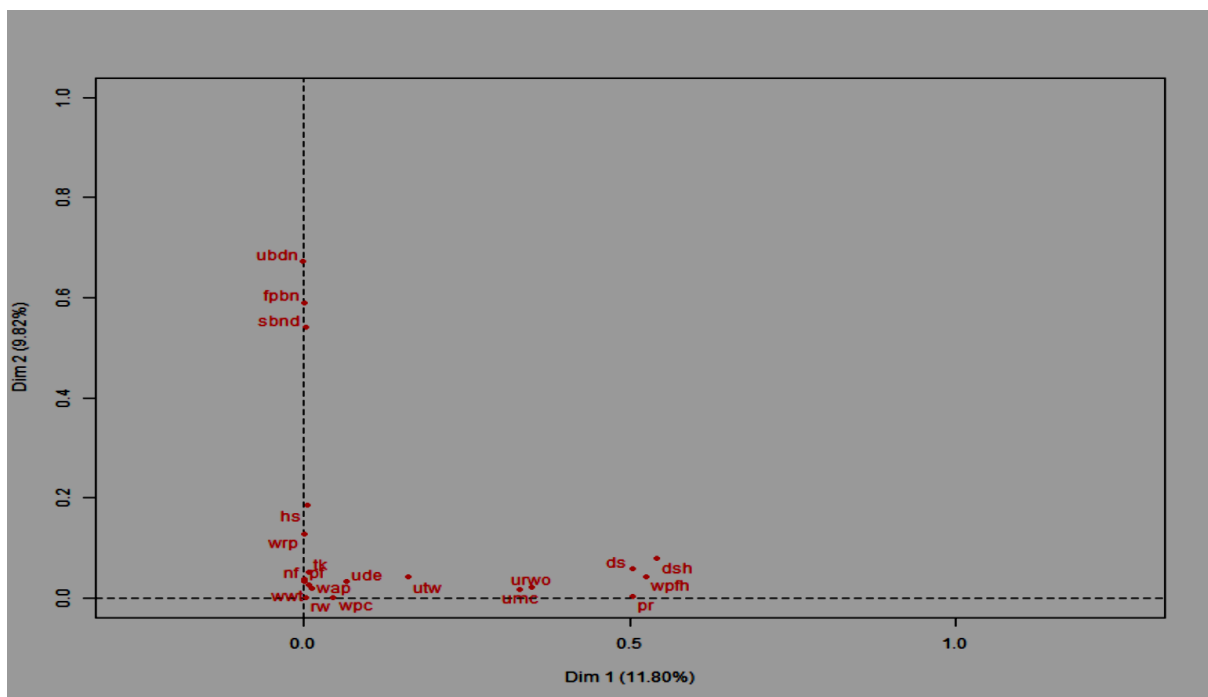
Other behaviors related to mosquito-borne diseases but were not taken into MCA, including travel history, Disease history of dengue and Japanese encephalitis, history of Japanese encephalitis vaccination and history of admitted in hospital in 2016.

**Result of Multiple correspondence analysis (MCA)**

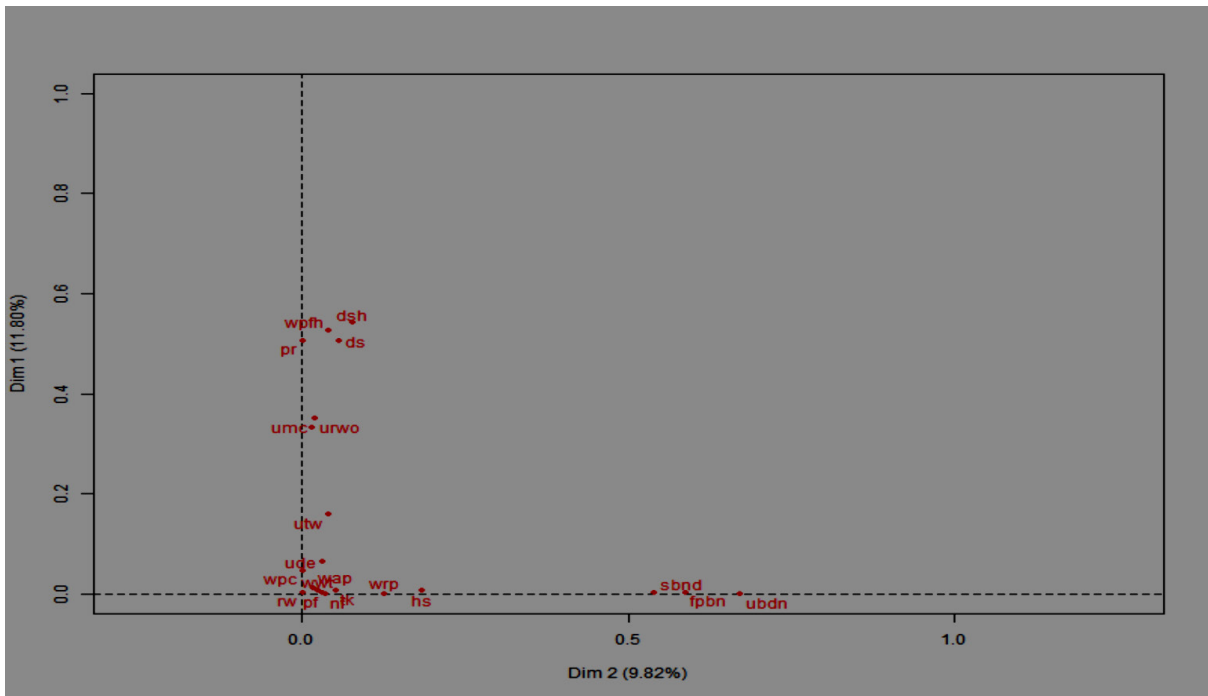
Table 2 indicated the levels of squared correlation between each categorical variable and three dimensions. Twenty active variables were selected into MCA. The abbreviations in the second column are used in subsequent graphic exploration. Ten variables contributed most among 3 dimensions. Based on the nature of correlation between item and dimension. The dimensions were identified: (1) pig rearing environment; (2) bed-net using behavior; (3) repellent using behaviors, respectively. Other variables including near to forest, running water, they did not correlate to one and other. They were not contributing by these three dimensions. Since MCA always use 2-3 dimensions to explain the results; and those three dimensions could explain about 30 percent of total variance of behaviors and environments, our analysis was thus confined to only three dimensions.

Figure 1 shows that various variables (abbreviation in Table 2) very well align along the axes of the three dimensions. A series two-dimension spaces displayed the mapping of environmental factors and personal behaviors on bed-net using and usage of repellent in Figure 2 to Figure 4. Different colors of the dots (denoting individuals with different subgroups of behavior variables) are well separated. Thus the dimensions well classify the individual by their behaviors.

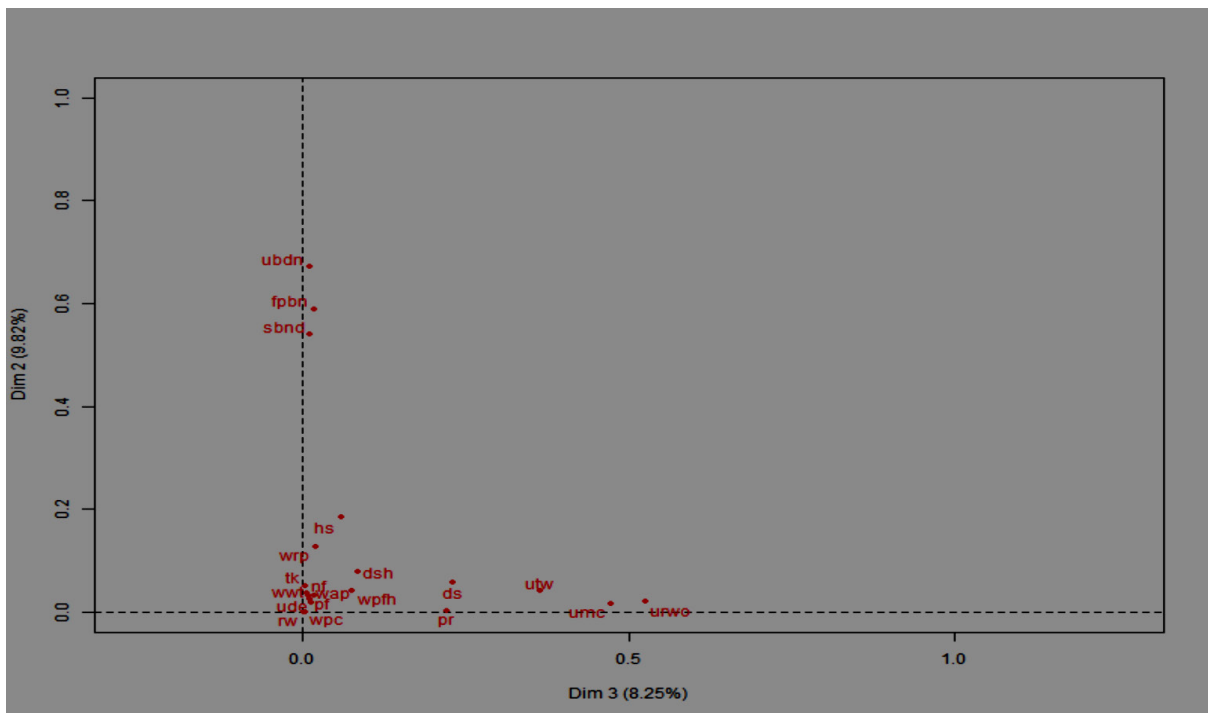
**Dimension 1 by Dimension 2**

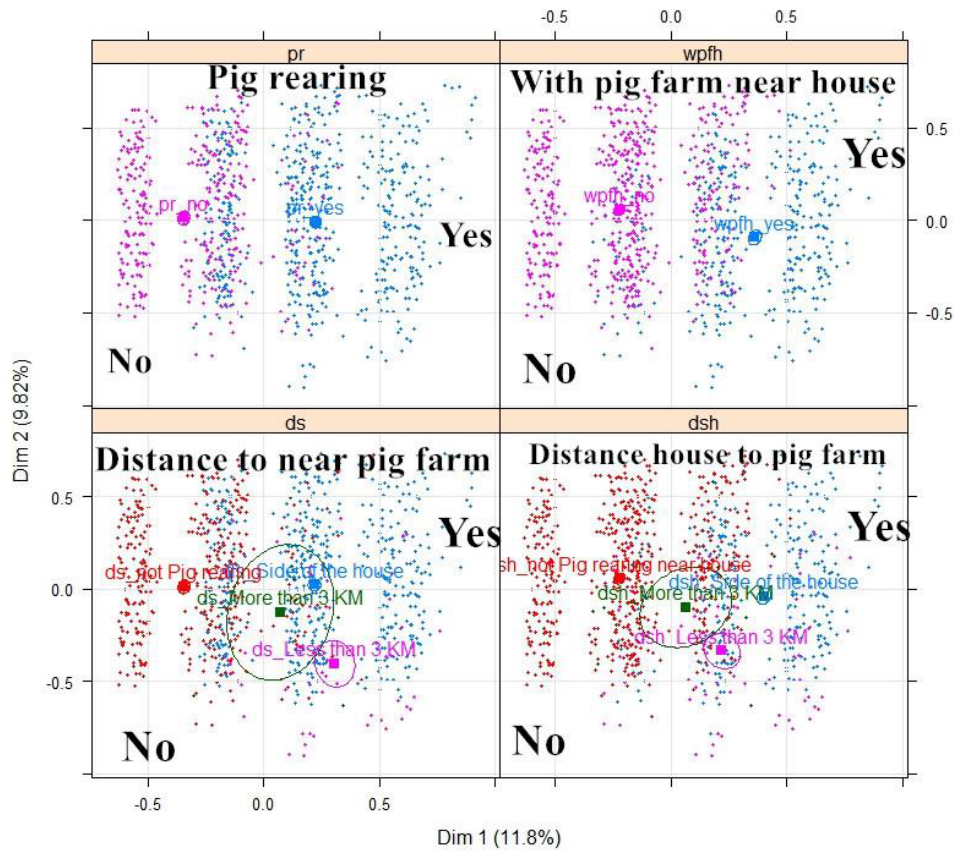


### Dimension2 by Dimension 1

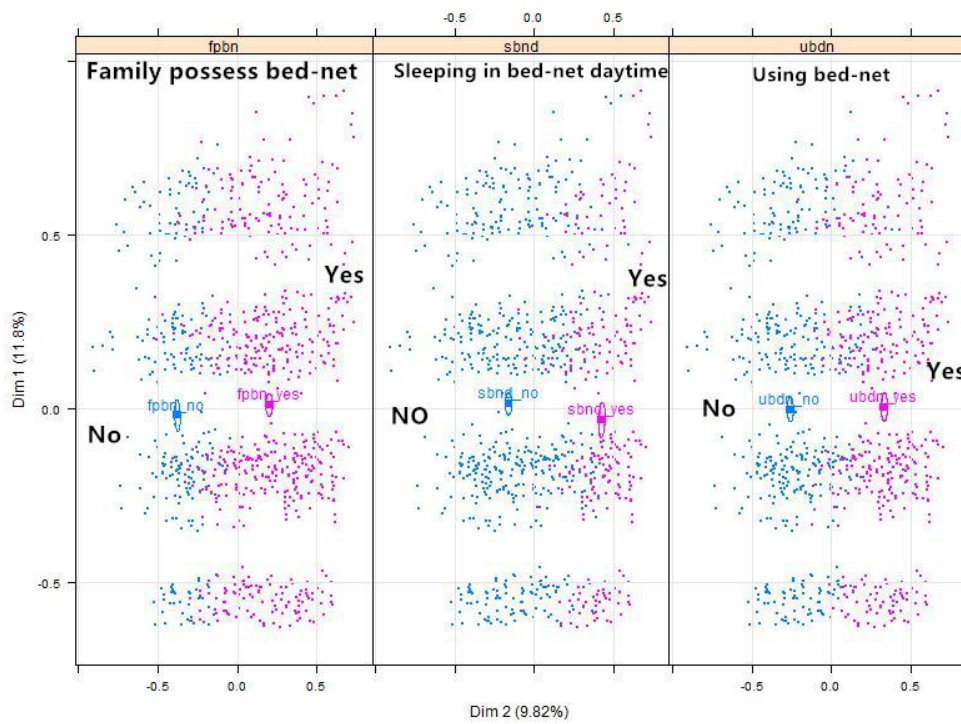


### Dimension3 by Dimension2

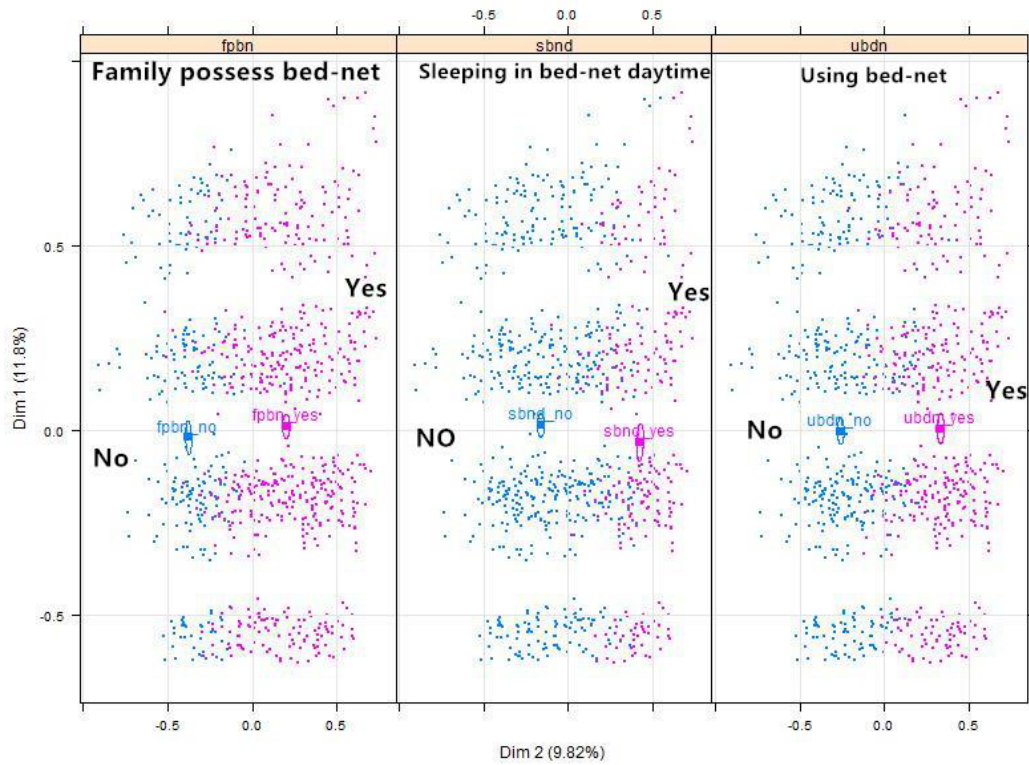




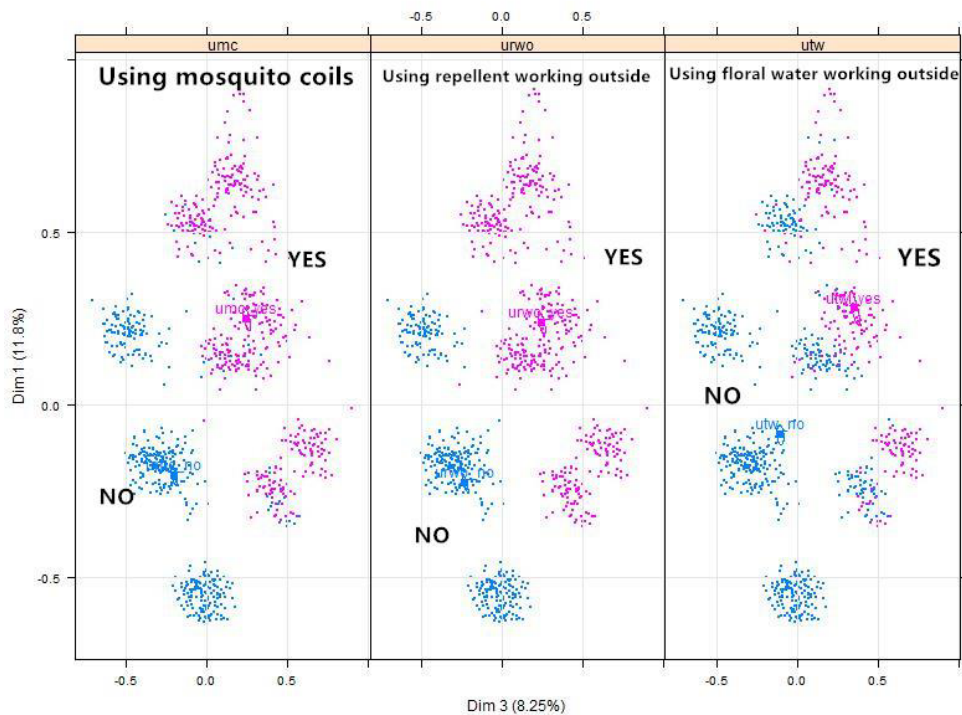
**Figure 1** multiple correspondence analysis map among the environmental and behavior variables



**Figure 2** Typology of dimension1 environmental factors



**Figure 3** Typology of dimension2 bed-net using behaviors



**Figure 4** Typology of dimension3 repellent using behaviors

#### 4.2 Discussion

By using MCA, we could group 10 out of 20 variables into 3 dimensions of mosquito-borne diseases behaviors namely, pig rearing environment, bed-net using behaviors and repellent using behaviors.

Pig rearing of environment were stronger associated with Japanese encephalitis. Existing studies revealed that the practice of paddy cultivation and pig rearing environment are two main risk factors of JE prevalence [7-12].

Bed-net using is well known to prevent mosquito-borne diseases. International health groups are providing long-lasting, insecticide-treated nets (LLIN) to residents in malaria endemic areas of underdeveloped countries, particularly in Africa. In such areas, regular use of insecticide-treated bed nets can reduce childhood mortality up to 20% and severe disease up to 50% [13, 14]. In sub-Saharan Africa, ITNs are a popular tool for malaria control [15]. Local residents are at high risk to mosquito-borne diseases, such as malaria, dengue fever, Japanese encephalitis, chikungunya and zika virus infection. It is important to improve the health education programme to ensure universal use of bed-net in this area.

Topical insect repellents are recommended by health authorities to avoid mosquito bites and prevent mosquito-borne disease[16]. Broadly defined, repellents are products used by individuals to reduce the number of bites from hematophagous arthropods [17]. Such products include topical repellents applied directly, to the skin, but they also include compounds on clothing, insecticide-treated bed nets (ITN) and various devices that emit vapor or droplets into a small space (e.g. mosquito coils)[18]. On a practical level, repellents can reduce the incidence of disease caused by vector-borne pathogens but they can only rarely eliminate the risk because of the imperfections of use by individuals. Personal protection measures must be used correctly to be effective. In our study sites, the use of repellent rate was 49% (635/1295). Whether they use correctly or not are needed further research.

This study was limited by the fact that half of the other item variables could not be grouped. However, the variables are rather non-specific and likely to play less important role in disease control. Further exploration is needed.

## 5. Conclusions

The nature of major risk behaviors related to mosquito-borne diseases can be divided into 3 dimension, pig rearing of environment, bed-net using behaviors and repellent using behaviors respectively along with China-Lao Border area. The finding from this study would be helpful in planning of various mosquito-borne diseases prevention and control in this area.

## Competing interests

The fieldwork was supported by Yunnan Institute of Parasitic Diseases. All authors declare that they have no competing interesting.

## Acknowledgments

The authors are grateful to staff of the Xishuangbanna Prefecture CDC: Mr. Jianhua Fan for supporting the fieldwork, the Mengla County CDC: Dr. Junming Li, Mr. Huaxin Liu, Dr. Yujiang Xiao and all the staff of five study sites Health center for supporting the fieldwork.

## References

- [1] Organization WH. A global brief on vector-borne diseases. 2014.
- [2] Phommanivong V, Kanda S, Shimono T, Lamaningao P, Darcy AW, Mishima N, et al. Co-circulation of the dengue with chikungunya virus during the 2013 outbreak in the southern part of Lao PDR. *Tropical Medicine and Health*. 2016;44(1):24.
- [3] Guo X, Yang H, Wu C, Jiang J, Fan J, Li H, et al. Molecular characterization and viral origin of the first dengue outbreak in Xishuangbanna, Yunnan Province, China, 2013. *The American Journal of Tropical Medicine and Hygiene*. 2015;93(2):390-3.
- [4] Le Roux B, Rouanet H. *Geometric Data Analysis: from Correspondence Analysis to Structured Data Analysis*: Dordrecht, Kluwer; 2004 2004. 475 p.
- [5] Nenadic O, Greenacre M. *Correspondence analysis in R, with two-and three-dimensional graphics: The Ca Package*. 2007.
- [6] Lê S, Josse J, Husson F. *FactoMineR: An R Package for Multivariate Analysis*. *Journal of Statistical Software*. 2008;25(1):1-18.
- [7] Phukan A, Borah P, Mahanta J. Japanese encephalitis in Assam, northeast India. *Southeast Asian Journal of Tropical Medicine and Public Health*. 2004;35:618-22.
- [8] Dwibedi B, Mohapatra N, Rathore SK, Panda M, Pati SS, Sabat J, et al. An outbreak of Japanese encephalitis after two decades in Odisha, India. *The Indian Journal of Medical Research*. 2015;142 (Suppl 1):S30.
- [9] Richards EE, Masuoka P, Brett-Major D, Smith M, Klein TA, Kim HC, et al. The relationship between mosquito abundance and rice field density in the Republic of Korea. *International Journal of Health Geographics*. 2010;9(1):1.



- [10] Masuoka P, Klein TA, Kim H-C, Claborn DM, Achee N, Andre R, et al. Modeling the distribution of *Culex tritaeniorhynchus* to predict Japanese encephalitis distribution in the Republic of Korea. *Geospatial Health*. 2010;5(1):45-57.
- [11] Impoinvil DE, Solomon T, Schluter WW, Rayamajhi A, Bichha RP, Shakya G, et al. The spatial heterogeneity between Japanese encephalitis incidence distribution and environmental variables in Nepal. *PloS One*. 2011;6(7):e22192.
- [12] Khan S, Narain K, Handique R, Dutta P, Mahanta J, Satyanarayana K, et al. Role of some environmental factors in modulating seasonal abundance of potential Japanese encephalitis vectors in Assam, India. *Southeast Asian Journal of Tropical Medicine and Public Health*. 1996;27:382-91.
- [13] Lindsay S, Adiamah J, Miller J, Armstrong J. Pyrethroid-treated bednet effects on mosquitoes of the *Anopheles gambiae* complex in The Gambia. *Medical and Veterinary Entomology*. 1991;5(4):477-83.
- [14] Gimmig JE, Kolczak MS, Hightower AW, Vulule JM, Schoute E, Kamau L, et al. Effect of permethrin-treated bed nets on the spatial distribution of malaria vectors in western Kenya. *The American Journal of Tropical Medicine and Hygiene*. 2003;68(4\_suppl):115-20.
- [15] Lengeler C. Insecticide-treated bed nets and curtains for preventing malaria. *The Cochrane Library*. 2004.
- [16] Webba CE, Hessc IM. A review of recommendations on the safe and effective use of topical mosquito repellents. *Public Health Research & Practice*. 2016;26(5).
- [17] White G. Terminology of insect repellents. *Insect repellents. Principles, methods and uses*. Edited by: Debboun M, Frances SP, Strickman D. 2007. Boca Raton: CRC Press.
- [18] Strickman D, Frances SP, Debboun M. *Prevention of bug bites, stings, and disease*: Oxford University Press; 2009.

# Effect of Methotrexate on Interleukin-36 $\gamma$ Serum Levels in Psoriasis: A pilot study

Attawut Limsaengrat<sup>1</sup>, Jitlada Meephansan<sup>1,\*</sup> and Achara Phumyen<sup>2</sup>

<sup>1</sup> Division of Dermatology, Chulabhorn International College of Medicine, Thammasat University,  
Phahonyothin Road, Klonglung, Pathum Thani Thailand 12120

<sup>2</sup> Chulabhorn International College of Medicine, Thammasat University, Phahonyothin Road, Klonglung,  
Pathum Thani Thailand 12120

## Abstract

**Background:** Interleukin 36  $\gamma$  (IL-36 $\gamma$ ), a member of the IL-1 family, is the molecule that can stimulate pro-inflammatory pathway, which can induce several cytokines and chemokines that take responsibility in the inflammatory process in many diseases, including psoriasis. The recent study, IL-36 $\gamma$  was found to be highly specific to psoriasis when compared with other inflammatory skin diseases. Methotrexate (MTX) is an immunosuppressive drug that commonly used to treat various types of psoriasis. It has multiple abilities including anti-proliferation, anti-inflammation, and immunosuppression, resulting from the inhibition of various enzymes and cytokines, but the effect of MTX on IL-36 $\gamma$  serum levels in psoriasis subject is still unknown.

**Objective:** To investigate the correlation of PASI score and IL-36 $\gamma$  serum levels of psoriasis subjects before and after methotrexate treatment.

**Methods:** Eight subjects with moderate-to-severe plaque-typed psoriasis were given MTX 15 mg per week for up to 12 weeks. The PASI score was evaluated at baseline and when the PASI score reached 75% improvement or up to 12 weeks. Serum levels of IL-36 $\gamma$  were determined by enzyme-linked immunosorbent assay (ELISA) before and after treatment.

**Results:** IL-36 $\gamma$  serum levels were detectable in all 8 subjects at baseline ( $358.21 \pm 45.84$  pg/ml). After MTX treatment, the mean of PASI score of all 8 subjects had significant reduction from before and after treatment ( $p = 0.003$ ). There was no significant correlation between IL-36 $\gamma$  serum levels and PASI score in both before and after treatment ( $r = -0.168$ ,  $p = 0.692$  and  $r = 0.441$ ,  $p = 0.274$ , respectively)

**Conclusion:** No correlation between PASI score and IL-36 $\gamma$  serum levels of psoriasis subjects before and after methotrexate treatment. Even though, all the subjects had significant reduction of PASI score.

**Keywords:** Interleukin-36 $\gamma$ , psoriasis, methotrexate

## 1. Introduction

Psoriasis is a common, chronic inflammatory skin disease with polygenic predisposition combined with the immune-mediated disorder and environmental triggering factors, which affect the quality of life, both physically and mentally. In addition, psoriasis subjects have relatively higher risk for metabolic syndrome, cardiovascular disease and rheumatologic comorbidities [1].

Interleukin-36 is a novel member of the IL-1 family. It consists of IL-36 $\alpha$ , IL-36 $\beta$  and IL-36 $\gamma$ . These cytokines bind to the IL-1Rrp2 (IL-36R) and co-receptor, IL-RAcP [3]. IL-36 is produced by macrophages, DC, and lymphocytes, which are found abundantly in keratinocytes of the skin and a few other tissues, such as bronchial epithelium and synovial fibroblasts [4, 5]. The production of IL-36 can be induced by environmental factors directly stimulate keratinocytes and via the stimulation of DCs/Langerhans cells to secrete IL-1, IL-6, and IL-23 that later stimulate Th17 and  $\gamma\delta$  T cells to secrete IL-6, TNF- $\alpha$ , IL-17, IL-22, and IFN- $\gamma$ , resulting in IL-36 $\gamma$  production [6]. Its function is to stimulate pro-inflammatory pathway by activating the mitogen-activate protein kinase and NF- $\kappa$ B signal transduction. Its signal can induce the production of cytokines (e.g. IL-6, IL-8, IL-17, TNF- $\alpha$ ), and chemokines (e.g. CXCL8, CCL20) that take responsibility in the inflammatory process processes [7].

---

\* Corresponding author; e-mail: kae\_mdca@yahoo.com

The recent study showed that IL-36 $\gamma$ , which is highly expressed in psoriatic skin lesions, was highly specific for psoriasis but weakly expressed in other inflammatory skin diseases including atopic dermatitis (AD), contact eczema (CE) and lichen planus (LP). Not only in the psoriatic skin lesions, but IL-36 $\gamma$  in peripheral blood serum levels also highly correlated with the severity of the disease, evaluated by PASI score, and significantly decreased after treated with etanercept, anti-TNF- $\alpha$ . Thus, IL-36 $\gamma$  may now be a potential biomarker in psoriasis subjects [2]. Nevertheless, the role of IL-36 $\gamma$  is not completely defined.

Methotrexate (MTX) is a derivative of aminopterin, which mechanism of action is to inhibit dihydrofolate reductase (DHFR), an enzyme for the reduction of dihydrofolate (DHF) to tetrahydrofolic acid (FH<sub>4</sub>). The mechanism of action of MTX including inhibition of DNA synthesis, reinforcement of the T cells apoptosis and inhibition of the chemotaxis of neutrophils. In addition, MTX can also decrease the synthesis of pro-inflammatory cytokines such as TNF- $\alpha$ , IL-1, IFN- $\gamma$  (8, 9). The reduction of TNF- $\alpha$  [10], IFN- $\gamma$  [11] combined with the suppression of NF- $\kappa$ B pathway contribute to lowering protein and gene expression of caspase-1, which lead to the reduction of hyper-proliferating keratinocytes in the psoriatic epidermis [12]. We used therapeutic model with MTX, which is widely used and very effective to treat moderate-to-severe plaque-type psoriasis in Thailand, to evaluate the correlation between IL-36 $\gamma$  serum levels and PASI score.

## 2. Research objective

To investigate the correlation of PASI score and IL-36 $\gamma$  serum levels of psoriasis subjects before and after methotrexate treatment.

## 3. Materials and methods

### Subjects and samples

Eight subjects with moderate-to-severe plaque-typed psoriasis (6 males, 2 females, mean age 42.25 years) at Thailand Tobacco Monopoly Hospital were enrolled. The severity of the subject was evaluated by using 'Psoriasis Area and Severity Index (PASI)' (<10=mild, 10-15=moderate, >15=severe). Subjects with pregnancy or lactation, psoriatic arthritis, IL-36 $\gamma$  associated diseases (HSV infection, inflammatory bowel disease, COPD, asthma), cancer, autoimmune disease, and immunocompromised conditions were excluded from the study. All the subjects were given oral MTX 15 mg once a week up to 12 weeks. The subjects in this study must not use topical therapies within 2 weeks, and systemic therapies within 4 weeks prior the study period. During the study, the subjects were not given any other medications. The study was approved by the Ethics Committee of Thammasat University and all participants signed an informed consent.

### Measurement of IL-36 $\gamma$ serum levels

The peripheral blood was collected from the subjects and centrifuged to separate the serum at baseline and when the PASI score reached 75% improvement or up to 12 weeks. The IL-36 $\gamma$  serum levels were measured by enzyme-linked immunosorbent assay (ELISA) kit (RayBiotech, Inc., Norcross, Georgia, USA). All samples and standards were measured in duplicate.

### Statistical analysis

The frequency (%) was used to evaluate qualitative data and mean  $\pm$  SD was used to evaluate quantitative data for demographic of the subjects, PASI score and IL-36 $\gamma$  serum levels. Correlation analyses between IL-36 $\gamma$  serum levels and PASI score was performed by Pearson correlation. *p*-value <0.05 was considered to be significant.

## 4. Results

Baseline characteristics of the subjects are demonstrated in Table 1. PASI score and IL-36 $\gamma$  serum levels at baseline and after treatment are demonstrated in Table 2.

IL-36 $\gamma$  serum levels were detectable in all subjects at baseline (358.21  $\pm$  45.84 pg/ml). After treatment with MTX, 4 of 8 subjects (50%) had reached 75% PASI score improvement. There was a significant reduction of mean PASI score from before and after treatment (*p* = 0.003). There was no significant correlation between IL-36 $\gamma$  serum level and PASI score in both before and after treatment (*r* = -0.168, *p* = 0.692 and *r* = 0.441, *p* = 0.274, respectively) (Figure 1).

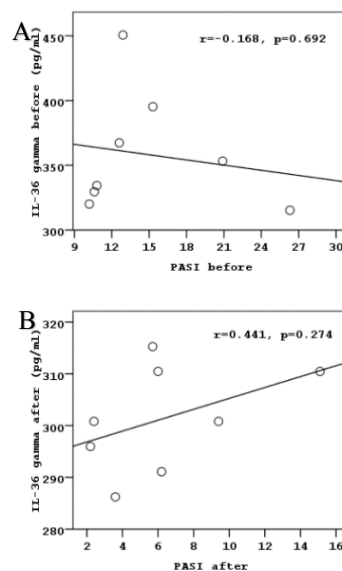
**Table 1** Baseline characteristics of the subjects

		Total (n=8)	
Values are presented as mean. BMI, body mass history.	Age (years)	<b>42.25 ± 15.29</b>	
	Sex		
	Male	6 (75%)	frequency (%) and index; FH, family
	Female	2 (25%)	
	Body Mass Index	28.71 ± 6.53	
	Smoking	3 (37.5%)	
	Alcohol Drinking	2 (25%)	
FH of Psoriasis	3 (37.5%)		

**Table 2** PASI scores and IL-36 $\gamma$  serum levels for each psoriasis subject.

Subject No.	PASI before treatment	PASI after treatment	IL-36 $\gamma$ (pg/ml) serum levels before treatment	IL-36 $\gamma$ (pg/ml) serum levels after treatment
1	12.6	5.7	367.315	315.258
2	10.8	6.2	334.338	291.097
3	12.9	9.4	450.617	300.807
4	20.9	15.1	353.238	310.455
5	26.3	6	315.258	310.455
6	10.2	2.2	320.046	295.96
7	15.3	3.6	395.265	286.217
8	10.6	2.4	329.586	300.807

PASI, Psoriasis Area and Severity Index.



**Figure 1** IL-36 $\gamma$  serum levels and PASI score in psoriasis subjects. A) Correlation between IL-36 $\gamma$  serum levels and PASI score at baseline ( $r = -0.168$ ,  $p = 0.692$  and). B) Correlation between IL-36 $\gamma$  serum levels and PASI score after treatment with MTX ( $r = 0.441$ ,  $p = 0.274$ ).

## 5. Discussion

The effect of MTX on IL-36 $\gamma$  serum levels remains unknown. To our knowledge, MTX has antiproliferative and anti-inflammatory effect by reducing the synthesis of several pro-inflammatory cytokines (e.g. TNF- $\alpha$ , IL-1, IFN- $\gamma$ , IL-22) [8, 13, 14], which may lead to the reduction of IL-36 $\gamma$  production, since the production of IL-36 can be induced by IL-6, TNF- $\alpha$ , IL-17, IL-22, IFN- $\gamma$  and IL-36 itself [15]. This study has

demonstrated that there is no significant correlation between IL-36 $\gamma$  serum levels and PASI score before and after treated with MTX. Even though, all the subjects have significant reduction of PASI score. Resulting from the complexity of the immunopathogenesis of psoriasis, there are other immunogenic pathways that can induce the production of IL-36 $\gamma$  that MTX cannot inhibit, for example, the environmental factors and IL-36 $\gamma$  itself can directly induce keratinocytes to produce IL-36 $\gamma$ . From the result, all subjects have high level of IL-36 $\gamma$  (>50 pg/ml), thus there may be some other unknown pathway that can also induce the production of IL-36 $\gamma$ . Moreover, from the strong association between IL-36 $\gamma$  and neutrophil and its chemokines, which play important role in generalized pustular psoriasis (GPP) [16], therefore, IL-36 $\gamma$  may not strongly express in chronic plaque-type psoriasis, which has Th1/Th17 as a key component.

## References

- [1] Schleicher SM. Psoriasis: Pathogenesis, assessment, and therapeutic update. *Clin Podiatr Med Surg*. 2016;33(3):355-66.
- [2] D'Erme AM, Wilsmann-Theis D, Wagenpfeil J, Hölzel M, Ferring-Schmitt S, Sternberg S, et al. IL-36 $\gamma$  (IL-1F9) is a biomarker for psoriasis skin lesions. *J Investig Dermatol*. 2015;135(4):1025-32.
- [3] Wu Y LH, Jiang Z and Lai Y. The interleukin-1 family: A key regulator in the pathogenesis of psoriasis. *Austin J Clin Immunol*. 2014;1(5):1023.
- [4] Garlanda C, Dinarello CA, Mantovani A. The interleukin-1 family: back to the future. *Immunity*. 2013;39(6):1003-18.
- [5] Sims JE, Smith DE. The IL-1 family: regulators of immunity. *Nat Rev Immunol*. 2010;10(2):89-102.
- [6] Gabay C, Towne JE. Regulation and function of interleukin-36 cytokines in homeostasis and pathological conditions. *J Leukoc Biol*. 2015;97(4):645-52.
- [7] Vigne S, Palmer G, Lamacchia C, Martin P, Talabot-Ayer D, Rodriguez E, et al. IL-36R ligands are potent regulators of dendritic and T cells. *Blood*. 2011;118(22):5813.
- [8] Czarnecka-Operacz M, Sadowska-Przytocka A. The possibilities and principles of methotrexate treatment of psoriasis -- the updated knowledge. *Postepy Dermatol Alergol*. 2014;31(6):392-400.
- [9] Chan ES, Cronstein BN. Mechanisms of action of methotrexate. *Bulletin of the Hospital for Joint Disease* (2013). 2013;71 Suppl 1:S5-8.
- [10] Hildner K, Finotto S, Becker C, Schlaak J, Schirmacher P, Galle PR, et al. Tumour necrosis factor (TNF) production by T cell receptor-primed T lymphocytes is a target for low dose methotrexate in rheumatoid arthritis. *Clin Exp Immunol*. 1999;118(1):137-46.
- [11] Constantin A, Loubet-Lescoulié P, Lambert N, Yassine-Diab B, Abbal M, Mazières B, et al. Antiinflammatory and immunoregulatory action of methotrexate in the treatment of rheumatoid arthritis: Evidence of increased interleukin-4 and interleukin-10 gene expression demonstrated in vitro by competitive reverse transcriptase-polymerase chain reaction. *Arthritis Rheum*. 1998;41(1):48-57.
- [12] Thirupathi A, Elango T, Subramanian S, Gnanaraj P. Methotrexate regulates Th-1 response by suppressing caspase-1 and cytokines in psoriasis patients. *Clin Chim Acta*. 2016;453:164-9.
- [13] Fellermann K, Jewell DP, Sandborn WJ, Schölmerich J, Stange EF. *Immunosuppression in inflammatory bowel diseases: Standards, new developments, future trends*: Springer Netherlands; 2001.
- [14] Meehansan J, Ruchusatsawat K, Sindhupak W, Thorner PS, Wongpiyabovorn J. Effect of methotrexate on serum levels of IL-22 in subjects with psoriasis. *Eur J Dermatol*. 2011;21(4):501-4.
- [15] Carrier Y, Ma H-L, Ramon HE, Napierata L, Small C, O'Toole M, et al. Inter-Regulation of Th17 cytokines and the IL-36 cytokines In vitro and In vivo: Implications in psoriasis pathogenesis. *J Investig Dermatol*. 2011;131(12):2428-37.
- [16] Johnston A, Xing X, Wolterink L, Barnes DH, Yin Z, Reingold L, et al. IL-1 and IL-36 are dominant cytokines in generalized pustular psoriasis. *J Allergy Clin Immunol*. 2016;140(1):109-120.

# Formulation an Analgesic Spray containing *Cleome Viscosa* L. crude Extract

Peerasa Ariyavechakul<sup>1</sup>, Pилanthana Lertsatitthanakorn<sup>1</sup>, and Thien Thiraworawong<sup>1,\*</sup>

<sup>1</sup>Bansomdejchaopraya Rajabhat University, 1061 Isaraphab 15 Rd. Dhonburi, Bangkok 10600, Thailand

## Abstract

Nowadays, people lifestyle leads to muscle pain. *Cleome viscosa* L. commonly known as “Paksainpee” are widely used as analgesics to relieve muscle pain in Thai traditional medicine. This study aimed to analyze the groups of phytochemical compounds found in *Cleome viscosa* L. crude extract, formulate and study the stability of *Cleome viscosa* L. crude extract analgesic spray. Whole plant of *Cleome viscosa* L. was collected, cleaned, dried, milled and macerated with 95 % methanol followed by evaporation. The crude extract was analyzed the groups of phytochemicals by specific chemical reactions. The extract was formulated in dosage form of alcoholic spray solution. *Cleome viscosa* L. crude extract spray was quality controlled and analyzed the methanol residue by Gas Chromatography/Mass Spectrometry. The results revealed that methanolic crude extract of *Cleome viscosa* L. possessed alkaloids, steroids, tannins, terpenoids and flavonoids. Various formulae of alcoholic solution containing 6% crude extract were prepared. The best formula that possessed suitable characters was chosen. The selected spray formulation was quality controlled by physical stability test and found that pH, colour, odor including appearance did not change. Gas Chromatography/Mass Spectrometry revealed that no methanol residue appeared in the selected spray. In addition, skin irritation study of this spray was performed in volunteers by patch test. It was found that any volunteers did not show rash, redness and itching on the tested skin. In conclusion, methanolic crude extract of *Cleome viscosa* L. possessed alkaloids, steroids, tannins, terpenoids and flavonoids. The selected spray formulation was alcoholic solution containing 6% crude extract of *Cleome viscosa*. with possessing physical stability and no skin irritation. Therefore, these findings lead to clinical trial for evaluating the efficacy of *Cleome viscosa* L. crude extract spray for analgesic use and long term stability testing of this spray should be performed.

**Keywords:** *Cleome viscosa* L., phytochemical compounds, analgesic, spray, formulation

## 1. Introduction

*Cleome viscosa* L. (Capparaceae) called as “Paksainpee” is a common weed found in Thailand, India, Africa, and Pakistan. Whole plant (leaves, seeds, roots) are used traditionally to cure variety of diseases such as analgesic and anti-inflammatory for muscle pain [12]. The phytochemical analysis revealed presence of large range of bioactive compounds in *Cleome viscosa* L. crude extract such as alkaloids, flavonoids, tannins, phenols and sterols. However, the quantity of each phytochemical compounds group found in *Cleome viscosa* L. crude extract has depended on the extracted solvent [2],[10]. In addition, *Cleome viscosa* L. crude extract has possessed interesting pharmacological activities like wound healing, analgesic and anti-inflammatory, activities, anthelmintic, antimicrobial, immunomodulatory, antipyretic, antidiarrheal, and hepatoprotective activities [6]. *Cleome viscosa* L. promoted the wound repair process by attenuating the Smad-mediated collagen production in wound granulation tissue [13]. Khanam, *et al.* [5] has evaluated the analgesic and anti-inflammatory effects of *Cleome viscosa* L. crude extract in experimental animal models and found that the crude methanolic extract showed the highest activities. Analgesic activity of fixed oil distilled from *Cleome viscosa* L. seeds has performed and revealed that all doses of this oil were able to significantly decrease the number of writhes in comparison with aspirin by using the acetic acid induced writhing method [7]. This plant extract has not been developed as neither topical spray nor other pharmaceutical products before. This study aimed to analyze the groups of phytochemical compounds in *Cleome viscosa* L. crude methanolic extract and formulate in dosage form of analgesic spray. The physical stability and safety of the spray was determined. Hopefully, an analgesic spray containing *Cleome viscosa* L. crude extract might possess ability for further clinical trial study.

## 2. Materials and methods

### 2.1 Research objectives

- 1) To analyze the groups of phytochemical compounds found in *Cleome viscosa* L. crude extract.

---

\*Corresponding author, e-mail: Ariyaveda@hotmail.com

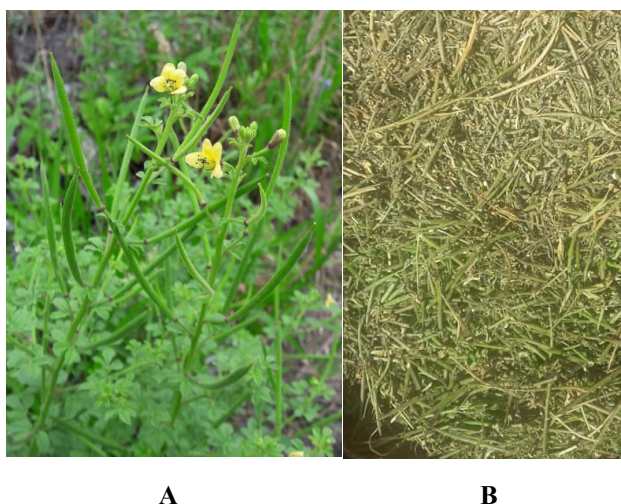
2) To formulate analgesic spray containing *Cleome viscosa* L. crude extract.

3) To study the physical stability and safety of the *Cleome viscosa* L. crude extract spray.

## 2.2 Equipments and chemicals

Rotary evaporator was made from Buchi (Switzerland). Hot air oven were bought from Memmert (Germany). Fume hood was made from Official equipment manufacturing Co. Ltd., Thailand. Freezer was produced by Panasonic (Thailand). Electronic balance was made from Metler-Toledo (Switzerland). Gas Chromatography was Agilent Model 6890 (USA) while mass spectrometer was Agilent Model 5973 (USA). DB Wax 30m x 0.25mm x 0.25 $\mu$ m capillary column was made from Agilent Technologies, USA. pH meter was bought from Becthai Bangkok Equipment & Chemical Co.,Ltd. Whatman filter papers no.1 were bought from Sigma-Aldrich Co. LLC (USA). Methanol, sulfuric acid, chloroform and petroleum ether were bought from Merck (Germany). Ammonia, magnesium ribbon, iron (III) chloride, were purchased from Ajax Finechem, New Zealand. Ingredients of liquid spray were bought from Namsiang Group Co.,Ltd. Thailand. Lemongrass oil was bought from Thai China Flavours & Fragrances Industry Co. (Thailand).

## 2.3 Plant Materials



**Figure 1** *Cleome viscosa* L. (A: whole plant, B: dry arial part)

Whole plant of *Cleome viscosa* L. (Paksainpee) including flowers and fruits were collected from the rural area along the 6<sup>th</sup> canal, Ongkarak, Lamlukka district, Pathum-Thani Province, Thailand. Its scientific name was identified by official botanist of The Office of the Forest Herbarium, Department of National Parks, Wildlife and Plant Conservation, Thailand.

## 2.4 *Cleome viscosa* L. extraction

Whole plant of *Cleome viscosa* L. with flowers and fruits were cleaned, size reduced and dried at 50 degree celcius in hot air oven for 5 hours. The dried plant was milled by Mulinex<sup>®</sup> for 20 seconds. The milled crude drug was macerated with 95 % methanol (1 part of crude drug: 5 parts of 95 % methanol) [5] with shaking 8 hours per day for consecutive 7 days. The resulting extract was filtered with Whatman No.1 filtering paper and evaporated using rotary evaporator. It was weighed and stored in well-closed amber container at 4 degree celcius before used.

2.5 Phytochemical screening test of *Cleome viscosa* L. crude extract. Modified from Onwuokeame MD., *et al.*[8]

Phytochemical screening were performed using standard procedures as follow.

- A. Salkowski test for terpenoids: 0.20 g of crude *Cleome viscosa* L. extract was extracted with 5 ml of petroleum ether three times. Afterthat, 2 ml of chloroform was added and shaken. Concentrated sulfuric acid was gradually added to form a layer. A reddish brown coloration of the solution's interface indicated the presence of terpenoids.
- B. Borntrager's test for anthraquinones: 0.20 g of crude *Cleome viscosa* L. extract was added to 10 ml of 10% sulfuric acid. The solution was warmed in water bath for 5 minutes, filtered and left for cooling at room temperature. Afterthat, the solution was extracted with chloroform. 2-3 drops of 10 % ammonia solution was added to this extract,. A pink-red color in the ammonia layer showed the presence of anthraquinones.
- C. Foaming test for saponins: 0.20 g of crude *Cleome viscosa* L. extract was extracted with 5 ml water by boiling on the water bath. The extract was then filtered and 3 ml of the extract was

transferred into a test tube and shaken. Then the extract was left to stand for 10 minutes. A thick stable foam indicated the presence of saponins.

- D. Test for flavonoids: 0.20 g of crude *Cleome viscosa* L. extract was dissolved in 3 ml of 50% ethanol. Three pieces of small magnesium ribbon were added and the solution was then boiled on the water bath. Concentrated hydrochloric acid was added and the resulting yellow or orange or red solution indicated the presence of flavonoids.
- E. Ferric chloride solution test for tannins: 0.20 g of crude *Cleome viscosa* L. extract was mixed with 5 ml of distilled water and warmed on the water bath. This extract was then filtered, treated with 3 drops of ferric chloride solution and shaken. A green-black or blue-black color solution indicated condensed tannins.
- F. Colour tests for alkaloids: 0.20 g of crude *Cleome viscosa* L. extract was dissolved in 15 ml of 2% sulfuric acid in a water bath for 2-3 minutes. The extract was then filtered and allowed to cool. 5 drops of the Dragendorff's reagent was added to the solution. The resultant orange-red precipitate indicated the presence of alkaloid.
- G. Cardiac Glycosides test: 0.20 g of crude *Cleome viscosa* L. extract was extracted with petroleum ether 2-3 times. Then, the extract was dissolved with 80% ethanol and the resulting solution was divided into 3 parts for these tests.

G1. Liebermann test for steroids: The above mentioned solution was dissolved in 3 drops of glacial acetic acid and 3 drops of concentrated sulfuric acid. The positive result which presented steroids should give a blue or blue-green colour solution at the interface of 2 layers.

G2. The unsaturated lactone ring test using Kedde reagent: The above mentioned solution was dissolved in Kedde reagent. Development of a violet color solution showed the presence of unsaturated lactone ring.

G3. Keller- Kiliani test for deoxy sugars in cardiac glycosides: The above mentioned extract was added glacial acetic acid, ferric chloride and sulfuric acid. A brown ring at interphase indicated the presence of deoxy sugars.

#### 2.6 Formulation development of *Cleome viscosa* L. crude extract spray

Due to an analgesic activity of 6% *Cleome viscosa* L. crude methanolic extract found in mice [4], various formulae of alcoholic solution containing 6% crude extract were prepared. The best formula possessing the best dissolving of *Cleome viscosa* L. crude extract, suitable pH, good spraying pattern, fast evaporation after spraying, no precipitation and satisfy odor was chosen. The developed was safe ingredients quantity did not exceed the limit of US-FDA [14].

#### 2.7 Physical stability test of *Cleome viscosa* L. crude extract spray

Physical stability testing of the best formula of *Cleome viscosa* L. crude extract spray was done in accelerated conditions using freeze thaw cycling method. One cycle composed of keeping the spray at 4 °C for 12 hours and at 45 °C for 12 hours. The spray was kept for 5 cycles. In addition, physical stability of product was also tested in the room temperature for 4 weeks. The spray was determined physical characteristics change consisting of color, smell, texture, separation, and pH before and after testing [3].

#### 2.8 Determination the methanol residue in *Cleome viscosa* L. crude extract spray

Methanol has a unique volatile chemicals. Thus, it can be separated by gas chromatography and identified by mass spectrometry. Therefore, gas chromatography / mass spectrometry (GC/MS) [1] was used to determine the methanol residue in *Cleome viscosa* L. crude extract spray. GC conditions consisted of inlet temperature 230°C, Split mode 10:1, injection volume 1 µl, column flow 1.0 ml/min, carrier gas was helium, oven: 35 °C hold 10 min ramp to 150 (rate 10°C/min) and ramp to 220 (rate 30°C/min) hold 10 min. MS detector was scanned the mass in range of 10-35 amu. *Cleome viscosa* L. crude extract spray was filtered through nylon membrane and injected to GC/MS. Standard methanol dissolved in dichloromethane was also injected to GC/MS. The chromatogram of methanol and *Cleome viscosa* L. crude extract spray were obtained.

#### 2.9 Skin Irritation test of *Cleome viscosa* L. crude extract spray

The closed patch test was carried out in 10 healthy volunteers. The volunteers aged between 18-60 years old, both male and female who had a healthy skin, were included in the experiment after the permission of BSRU Ethics Committee. The forearm of volunteers were cleaned with distilled water followed by applying 1 cm<sup>2</sup> cotton patch soaked with *Cleome viscosa* L. crude extract spray for 12 hours. Afterthat, the forearms were cleaned and the irritation level was observed by volunteers and researchers [9].

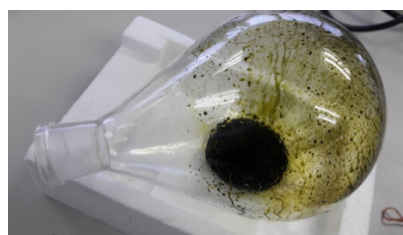
### 3. Results and discussion

*Cleome viscosa* L. was extracted 6 times and percentage of yield was shown in Table 1. The crude extract was green and viscous liquid as demonstrated in Figure 2.



**Table 1** Percentage of *Cleome viscosa* L. crude extract yield

Lot number	weight of crude drug (g)	weight of crude extract (g)	% yield
1	200.00	7.92	3.96
2	200.00	7.98	3.99
3	200.00	12.59	6.30
4	200.00	13.44	6.72
5	200.00	11.65	5.83
6	200.00	10.58	5.29
Mean±			5.35±
SD			1.17

**Figure 2** *Cleome viscosa* L. crude methanolic extract

The methanolic crude extract of *Cleome viscosa* L. possessed alkaloids, steroids, tannins, terpenoids and flavonoids (Figure 3 and Table 2). These groups of phytochemicals clearly related to topical use of *Cleome viscosa* L. in Thai traditional medicine. Because, most alkaloids possess analgesic activity while steroids and terpenoids show anti-inflammatory activity. In addition, flavonoids has been known as antioxidant that can reduce free radicals in human body and tannin is a good astringent [11]. Therefore, methanolic crude extract of *Cleome viscosa* L. was suitable to be developed as topical analgesic spray, with possessing anti-inflammatory activity and giving benefit to human skin.

**Figure 3** Phytochemical compound groups found in *Cleome viscosa* L. crude extract**Table 2** Phytochemical compound groups in *Cleome viscosa* L. crude extract

Chemical compound	Result
Anthraquinones	-
Terpenoids	+
Flavonoids	+
Saponin	-
Tannins	+
Alkaloids	+
Cardiac Glycoside	+
	Steroids
	Unsaturated lactone ring
	-

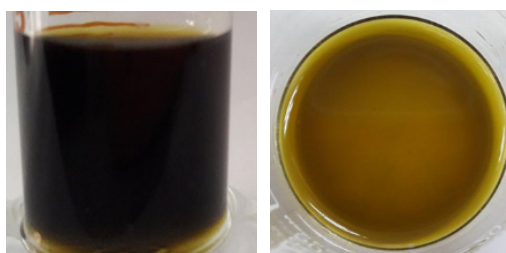
Deoxy sugar +

+ means positive test, - means negative test

Table 3 showed the ingredients of the best formula of *Cleome viscosa* L. crude extract spray and their functions. The appearance of selected *Cleome viscosa* L. crude extract spray was shown in Figure 4.

**Table 3** Formula of the best *Cleome viscosa* L. crude extract spray

Ingredient	Volume (%)	Function
<i>Cleome viscosa</i> L. crude extract	6	active ingredient
Ethanol	88.85	dissolving of <i>Cleome viscosa</i> L. crude extract
Glycerin	3	skin moisturizer
Butylene glycol	2	skin nourishing agent, skin moisturizer
Butylated hydroxyl toluene	0.05	anti-oxidant, anti-rancidity
Lemon grass essential oil	0.1	refreshing fragrance, reducing of stress and fatigue, lowering smell of <i>Cleome viscosa</i> L. crude extract



**Figure 4** Appearance of the selected *Cleome viscosa* L. crude extract spray

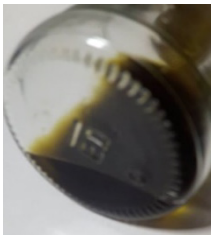

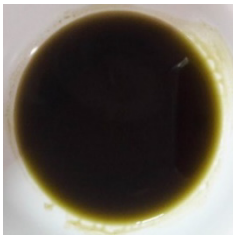
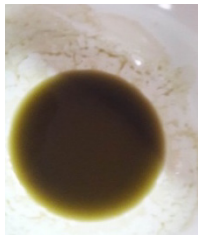
Chemical safety of this product has used the principle of safety and danger to human and environment as criteria. The maximum volume of each ingredient used in the recipe was regulated by U.S. Food and Drug Administration as shown in Table 4 (US-FDA, 2017). The developed *Cleome viscosa* L. crude extract spray in this research was safe because their ingredients quantity did not exceed the limit of US-FDA [14].

**Table 4** Maximum volume of solvents and compounds in topical solutions regulated by US-FDA

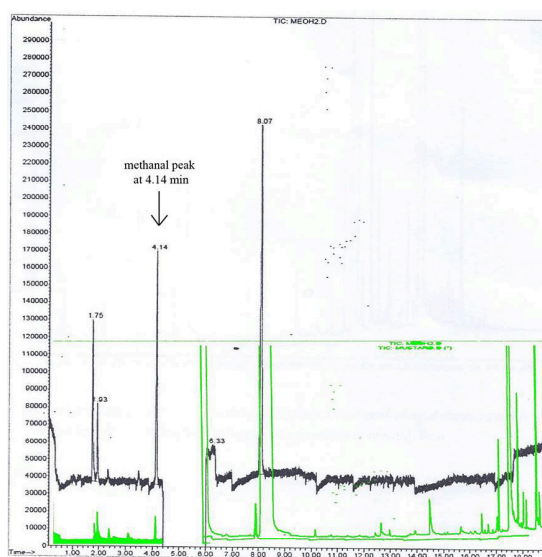
Chemical reagent	Maximum volume (%)
Alcohol	91.07
Glycerin	63.64
Butylene glycol	8.12
Butylated hydroxyl toluene	0.05 (w/w of topical sprays)
Lemongrass essential oil	Not defined

The best spray formulation was quality controlled by physical stability test and found that pH, colour, odor, texture including appearance did not change (Table 5). However, after 5 cycles of accelerated conditions and 4 weeks of room temperature storage, the selected spray showed a little bit of precipitation.

**Table 5** Physical properties of *Cleome viscosa* L. crude extract spray after physical stability testing

Physical property	Accelerated conditions for 5 cycles		Room temperature for 4 weeks	
	Before	After	Before	After
Color	Green	Green	Green	Green
Odor	Alcoholic and lemon grass smell	Alcoholic and lemon grass smell	Alcoholic and lemon grass smell	Alcoholic and lemon grass smell
Texture	Soft and smooth	Soft and smooth	Soft and smooth	Soft and smooth, sticky
Precipitation	No precipitation	A little bit of precipitation	No precipitation	A little bit of precipitation
pH	5.59±0.07	5.59±0.07	5.44±0.00	5.50±0.00
Appearance				

GC/MS revealed that no methanol residue appeared in the selected *Cleome viscosa* L. crude extract spray. Because, the chromatogram of standard methanol clearly showed the peak at 4.14 minute. On the other hand, the chromatogram of *Cleome viscosa* L. crude extract spray did not show any peak at 4.14 minute (Figure 5).

**Figure 5** GC chromatogram of standard methanol (upper) and *Cleome viscosa* L. crude extract spray (lower)

After skin irritation test of *Cleome viscosa* L. crude extract spray using closed patch method, skin irritation have not been observed in healthy volunteers as shown in Table 6. It was found that any volunteers did not show redness, swelling, pain, *peeling skin* and itching on the tested skin area. Therefore, the selected *Cleome viscosa* L. crude extract spray was safe and did not cause irritation. These findings lead to clinical trial for evaluation the efficacy of *Cleome viscosa* L. crude extract spray for analgesic use, especially relieving muscle pain in volunteers in the future.

**Table 6** Skin irritation of *Cleome viscosa* L. crude extract spray in healthy volunteers

Skin irritation level	Result
Redness	No
Swelling	No
Itching	No
Pain	No
<i>Peeling skin</i>	No

#### 4. Conclusions

The phytochemical compounds found in *Cleome viscosa* L. methanolic crude extract were alkaloids, steroids, tannins, terpenoids and flavonoids, which related to analgesic use of *Cleome viscosa* L. in Thai traditional medicine. 6 % of crude extract of *Cleome viscosa* L. was developed as topical analgesic sprays and the best formula possessed a physical stability because, this formula did not change in pH, colour, odor, texture including appearance after 5 cycles of accelerated condition storage. In addition, the developed spray was safe because GC/MS revealed that no methanol residue appeared in the selected *Cleome viscosa* L. crude extract spray. Therefore, the selected *Cleome viscosa* L. crude extract spray should be studied a clinical trial for evaluation an analgesic efficacy in the future.

#### Acknowledgements

The authors kindly thank Thai Tradition Medicine Program, Faculty of Science and Technology, Bansomdejchaopraya Rajabhat University for all facilities.

#### References

- [1] Aryasuk K. **Identification of Fatty Acid Methyl Ester on Two Serially Coupled Columns**. Bangkok: King Mongkut's University of Technology Thonburi; 2009.
- [2] Bainiwal LK, Vijayvergia P, Vijayvergia R. Determination of Preliminary Phytoconstituents, Total Phenolic and Flavonids Contents in the roots, leaves and stems of *Cleome Viscosa* Linn. **International Journal of Biological & Pharmaceutical Research**. 2013; **4**(12): 891-895
- [3] Ditnoi R. **Development of Foot Deodorant Spray Product Containing Tea Tree Essential Oil**. Bangkok: Kasetsart University; 2014.
- [4] Elufioye OT, Onoja OJ. Acute toxicity and histopathological a sssessment of methanol extract of *Cleome Viscosa* (Linn.) whole plant. **Journal of Medicinal Plant Research**. 2015; **9**(11): 360-369.
- [5] Khanam K, Begum M M, Md. Islam A, Zahan R, Md. Haque E. Studies on Atioxidant, analgesic anti-inflammatory and CNS Depressant Activities of the plant *Cleome viscosa* Linn. **International Journal of Innovative: Pharmaceutical Sciences and Research**. 2015; **3**(1): 12-28.
- [6] Mali RG. *Cleome viscosa* (wild mustard): A review on ethnobotany, phytochemistry, and pharmacology. **Pharmaceutical Biology**. 2010; **48**(1): 105-12.
- [7] Mohtasheem ul Hasan M, Salman A, Munnawar S, Iqbal A. Analgesic and Antiemetic activity of *Cleome viscosa* L. **Pakistan Journal of Botany**. 2011; **43**(1): 119-122.
- [8] Onwukeame DM, Ikuegbvweha TB, Asonye CC. Evaluation of phytochemical constituents, antibacterial activities and effects of exudates of *pycanthus angolensis* weld warb (mystriacaeceae) on corneal ulcers in rabbit. **Tropical Journal of Pharmaceutical Research**. 2007; **6**(2): 725-730.

- [9] Ruckbua S. **Comparative Study in Nickel Patch Test Reaction and Urine Nicker Level in Nicker Contact Dermatitis Patients between Chelated Zing and Placebo.** Bangkok: Srinakharinwirot University; 2007.
- [10] Saroop S, Kaul V. Preliminary Phytochemical Analysis of *Cleome Viscosa*-A Lesser Exolored Crop of Economic Importance Department of Botany. **International Journal of pharma and bio sciences.** 2015; **6**(1): 71-76.
- [11] Tabasum U, Mir MA, Parihar K, and Kumari E. Estimation of alkaloid, saponin and flavonoid, content in various extracts of *Crocus sativa*. **Journal of Medicinal Plants Studies.** 2016; **4**(5): 171-174
- [12] Toermwiset P. **Pramuan sapphakhun samunphrai Thai .12<sup>nd</sup> ed.** Bangkok: The Printing Office Agency to assist veterans in Royal sugar patham; 2012.
- [13] Upadhyay A, Chattopadhyay P, Goyary D, Mazumder PM, Veer V. Topical Application of *Cleome viscosa* Increases the Expression of Basic Fibroblast Growth Factor and Type III Collagen in Rat Cutaneous Wound. **Hindawi Publishing Corporation BioMed Research International.** 2014; Article ID 680879.
- [14] **U.S. FDA Food and Drug Administration. Inactive Ingredient Search for Approved Drug Products.** New Hampshire Avenue Silver Spring; 2017 [cited 9 May 2017]. Available from: [http:// www.accessdata.fda.gov/scripts/cder/iig/index.cfm](http://www.accessdata.fda.gov/scripts/cder/iig/index.cfm).

## **Influence of astaxanthin on the elicitation of allergic contact dermatitis to p-phenylenediamine: A pilot study.**

Suphattra Trakanwittayarak<sup>1,\*</sup>, Jitlada Meephansan<sup>1</sup>

Supitchaya Thaiwat<sup>1</sup>, and Suwimon Pootongkam<sup>1</sup>

<sup>1</sup>Division of Dermatology Chulabhorn International College of Medicine

Thammasat University, Thailand

### **Abstract**

Hair dyes represent one of the most important causes of allergic contact dermatitis resulting from the use of cosmetic products. The principal causative chemistry is associated with oxidation products of p-phenylenediamine (PPD) and closely related substances.

The aim of this pilot study was to compare whether pretreatment of the skin with the astaxanthin can reduce the elicitation reaction to PPD in allergic subjects.

In this pilot study, thirteen subjects with contact allergy to PPD, a documented skin reaction to a hair dye stimulation exposure model and history of hair dye-related skin complaints were used for the study. Skin areas on the forearm were exposed to an emulsion with astaxanthin and an emulsion without astaxanthin, and then to 1% PPD. In addition, control areas were exposed to the emulsions and to the PPD without pretreatment. Skin reactions were graded at 30 minutes, 48 hours, 72 hours, and on day 7.

Pretreatment with astaxanthin emulsion resulted in reduction a reaction in 1 out of 13 patients at 72 hours. No statistically significant difference between treatment and control group was observed at 30 minutes, 48 hours, and on day 7. Nevertheless, there were some limitations in our study such as small sample size and open patch test application.

In conclusion, pretreatment of the skin with the antioxidant astaxanthin had no an attenuating effect on the elicitation reaction to PPD in sensitized individuals.

**Keywords:** allergic contact dermatitis, Para-phenylenediamine, antioxidant, astaxanthin

---

\*Corresponding author; e-mail: dr.suphattra.tra@gmail.com, kae\_mdcu@yahoo.com

## 1. Introduction

Hair dyes represent one of the most important causes of allergic contact dermatitis. Para-phenylenediamine (PPD) is the most prevalent potent sensitizer found in the domestic hair dye product available on the markets [1].

Reactive oxygen species (ROS) play an important role in the stimulation and maintenance of both irritant and allergic contact dermatitis [2,3]. As a result of exposure of the skin to different irritants and allergens, ROS are upregulated and can disrupt the epidermal barrier [4,5]. ROS can activate several cellular signaling pathways, cause the secretion of various cytokines, and upregulate cellular surface molecules [6-8]. In order to limit damage to the tissue, ROS can be scavenged not only by antioxidative enzymes, such as certain glutathione-S-transferases, but also by many non-enzymatic antioxidants, such as water-soluble ascorbic acid (vitamin C) and lipid-soluble  $\alpha$ -tocopherol (vitamin E) [9]. Both non-enzymatic antioxidants belong to the group of chain-breaking antioxidants, which scavenge radicals by the termination of free radical reactions and prevention of chain propagation reactions.

Interestingly, Astaxanthin is a red carotenoid pigment contained in seafoods such as salmon and crabs. It is a fat soluble antioxidant which has its unique structure with the presence of hydroxyl and keto moieties on each ionone ring, which enables it to go through the membrane and protect the cell membrane in a way that no other antioxidant can [10]. In fact, astaxanthin has demonstrated antioxidant capacity 75 times greater than alpha lipoic acid. It was also about 550 times greater than green tea catechins, about 800 times greater than coenzyme Q10 and about 6000 times greater than Vitamin C [11]. Astaxanthin dose do not only have antioxidant activity against lipid peroxidation but also anti-inflammation, protection against damage by UV light and reduction of the immune response [12].

The aim of this study is to compare whether pretreatment of the forearm skin with the astaxanthin can reduce the elicitation of a contact allergic reaction to p-phenylenediamine. Group of subjects who are characterized with respect to their contact allergic reaction to PPD (history and patch test). Reading will be performed at 30 minutes, 48 hours, 72 hours and on day7 according to the conventional ICDRG criteria.

## 2. Materials and methods

### 2.1 Research objective

To compare pretreatment of the skin with the astaxanthin reduces the elicitation reaction to a p-phenylenediamine (PPD) in sensitized subjects.

### 2.2 Methods

This study was conducted from April 2017 to September 2017. The study was approved by Human Research Ethics Committee of the Thammasat University No.1 (Faculty of Medicine) and Institutional Review Board Royal Thai Army Medical Department.

### 2.3 Subjects

Number of PPD-allergic volunteers of 13 were calculated from previous study of Pieter-Jan Coenraads [13] and recruited into trial by the clinic of Dermatology of Medicine at Thammasat University, Phramongkutklo Hospital and Thailand Tobacco Monopoly Hospital, Thailand. All volunteers had a history of contact allergy to hair dye products, as proven by a positive diagnostic patch test result with 1% PPD in petrolatum. Volunteers were confirmed not to be taking any medication that might have interfered with the outcome of the study.

## 2.4 Test materials and procedure

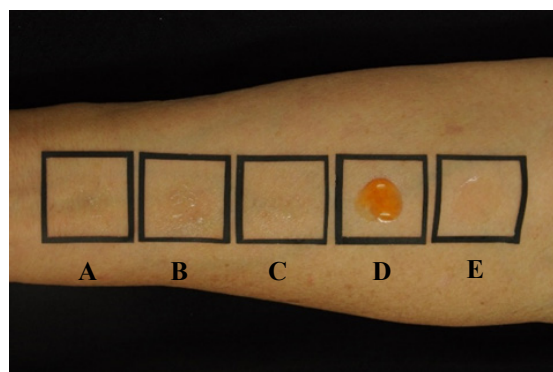
1% PPD in petrolatum was supplied by Allertech company (Smart Practice, Canada) and the emulsion with or without astaxanthin were supplied by Cosmaprof company (Bangkok, Thailand). Test emulsion with or without astaxanthin (delivering a concentration of 0.07%) after mixing with antioxidant activity system. All materials were stored at 4 °C until required for application to the skin. A minimum of 30 minutes was allowed for materials to equilibrate to ambient temperature prior to use.

Pretreatment with the emulsion with or without astaxanthin (0.3 ml) is applied in an open test to the volar side of forearm on two different (3.2 cm<sup>2</sup>) test areas for 10 minutes and then these substances are gently removed by cotton tip and followed by 1% PPD which is applied to a 0.8 cm<sup>2</sup> area in the center of these areas for 30 minutes. Moreover, on one area, 1% PPD without pretreatment with the emulsion is applied and also, two areas, the emulsions with or without astaxanthin are applied for 40 minutes. The placement pattern is shown in Figure 1.

- A: p-phenylenediamine (PPD) for 30 minutes
- B: Emulsion with astaxanthin for 10 minutes followed by PPD for 30 minutes
- C: Emulsion without astaxanthin for 10 minutes followed by PPD for 30 minutes
- D: Emulsion with astaxanthin for 40 minutes
- E: Emulsion without astaxanthin for 40 minutes

After that, these substances are gently removed by cotton tip and the interpretation of the result after applying the respective substances on the volar side of forearm are performed at 30 minutes, 48 hours, 72 hours, and on day 7, according to International Contact Dermatitis Research Group criteria (Table 1).

The primary comparison was made between the reaction on the skin area pretreated with an emulsion containing astaxanthin (area B) and the reaction on the areas that are pretreated with the emulsion without astaxanthin (area C) at 72 hours. The remaining areas were used as controlled areas to concern allergic or irritant reactions to ingredients of the antioxidant emulsion and antioxidant-free emulsion.



**Figure 1** Test setting. On the volar side of forearm: A. p-phenylenediamine (PPD) for 30 minutes; B. Emulsion with astaxanthin for 10 minutes followed by PPD for 30 minutes; C. Emulsion without astaxanthin for 10 minutes followed by PPD for 30 minutes; D. Emulsion with astaxanthin for 40 minutes; E. Emulsion without astaxanthin for 40 minutes.

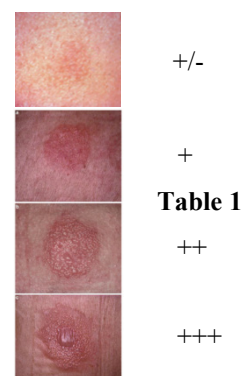


## 2.5 Outcome measurement

The cause of allergic contact dermatitis will be interpreted according to the International Contact Dermatitis Research Group criteria [14].

+/-	Doubtful reaction, faint macular erythema
+	Weak, non-vesicular reaction with erythema, infiltration and papules
++	Strong, vesicular reaction with erythema, infiltration and papules
+++	Spreading bullous reaction
-	Negative reaction
IR	Irritant reaction

International Grading System for patch tests.



**Table 1**

## 2.6 Data analysis

Data analysis and statistics were analysed with SPSS statistics version 17 for Windows. Testing for difference between patch test grading of the different areas at 30 minutes, 48 hours, 72 hours and on day 7 were performed with the non-parametric Wilcoxon signed-rank test. Outcomes with a p-value of  $< 0.05$  were considered to be statistically significant differences.

## 3. Results and discussion

### 3.1 Results

The results are summarized in Table 1. A total of 13 subjects participated in the study (3 males; 10 females; age 20-70 years). Atopic symptoms were reported in 2 subjects. None of them reported current symptoms of atopic dermatitis. One subject reported hairdressing as her occupation. Original patch test reactions (Table 1, column 2) were weakly positive (n=6), strongly positive (n=6), extremely strongly positive (n=1). None of subjects presented with any reactions on the controlled area D and E.

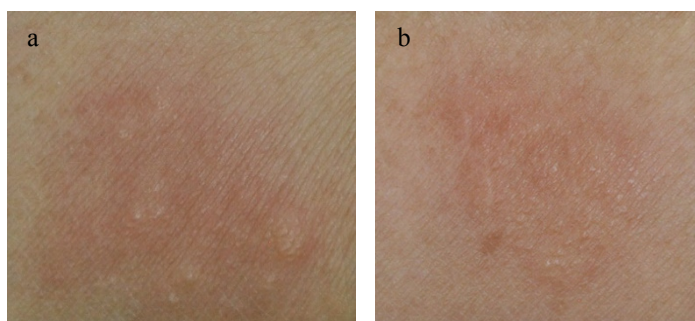
#### Pretreatment with astaxanthin

Elicitation reactions on the areas that were pretreated with emulsion with astaxanthin are shown in columns 4 (30 minutes), 7 (48 hours), 10 (72 hours), and 13 (day 7) of Table 1. A comparison of column 5 (30 minutes), 8 (48 hours), 11 (72 hours), and 14 (day 7) (pretreatment with an emulsion without astaxanthin) shows that astaxanthin reduced the grade of the elicitation reaction to the PPD in 1 out of 13 subjects at 72 hours (an impression of the reduced graded is shown in Figure 2), which does not have statistically significant difference (p=1). Also on day 7, 1 out of 13 subjects showed a reduced reaction (p=1), which does not have statistically significant difference. Same subject had reduced reactions on the 72<sup>nd</sup> hour and 7<sup>th</sup> day. Moreover, two subjects did not have reaction during test period.

**Table 2** Results of the open-use test at 30 minutes, 48 hours, 72 hours, and day 7

1	2	3	4	5	6	7	8	9	10	11	12	13	14
		30minutes			48 hours			72 hours			Day 7		
Subject no.	Original patch test	PPD	Asx +PPD	Asx-free +PPD	PPD	Asx +PPD	Asx-free +PPD	PPD	Asx +PPD	Asx-free +PPD	PPD	Asx +PPD	Asx-free +PPD
1	2+ (48hr)	-	-	-	+	+	+	+	+	+	+	+	+
2	1+ (48hr)	-	-	-	-	-	-	-	-	-	-	-	-
3	2+ (48hr)	-	-	-	+	+	+	2+	2+	2+	2+	2+	2+
4	1+ (48hr)	-	-	-	+	+	+	+	+	+	+	+	+
5	2+ (48hr)	-	-	-	+	+	+	+	+	+	+	+	+
6	2+ (72hr)	-	-	-	+	+	+	+	+	+	+	+	+
7	2+ (48 hr)	-	-	-	+	+	+	+	+	+	+	+	+
8	3+ (48 hr)	-	-	-	2+	2+	2+	3+	2+	2+	2+	+	+
9	2+ (48 hr)	-	-	-	+	+	+	+	+	+	-	-	-
10	1+ (72 hr)	-	-	-	-	-	-	-	-	-	-	-	-
11	1+ (48 hr)	-	-	-	+	+	+	-	-	-	-	-	-
12	1+ (72 hr)	-	-	-	+	+	+	+	+	+	+	+	+
13	1+ (48 hr)	-	-	-	+	+	-	-	-	-	-	-	-

Pretreatment with an emulsion with astaxanthin resulted in a reduction in the elicitation reaction to a 1% p-phenylenediamine (PPD) as compared with pretreatment with emulsion without astaxanthin, at 72 hours (Wilcoxon signed-rank test,  $p=1$ ), which does not have statistically significant difference. On day 7, no difference was seen between the strength of the reaction in the areas pretreated with the emulsion with astaxanthin and the areas pretreated with the emulsion without astaxanthin (Wilcoxon signed-rank test,  $p=1$ ). PPD: reaction on open use test with 1% PPD in petrolatum. Asx+PPD: reaction on open use test with pretreatment with emulsion with astaxanthin, followed by exposure to 1%PPD. Asx-free+PPD: reaction on open use test with pretreatment with emulsion without astaxanthin.



**Figure 2** An impression of the reduced elicitation reaction after pretreatment with astaxanthin. (a) Area A: the elicitation reaction as result of exposure to a 1% PPD in petrolatum, showing erythema and coalescing vesicles. (b) Area B: the emulsion with astaxanthin, showing erythema, papules, and some vesicles.

### 3.2 Discussion

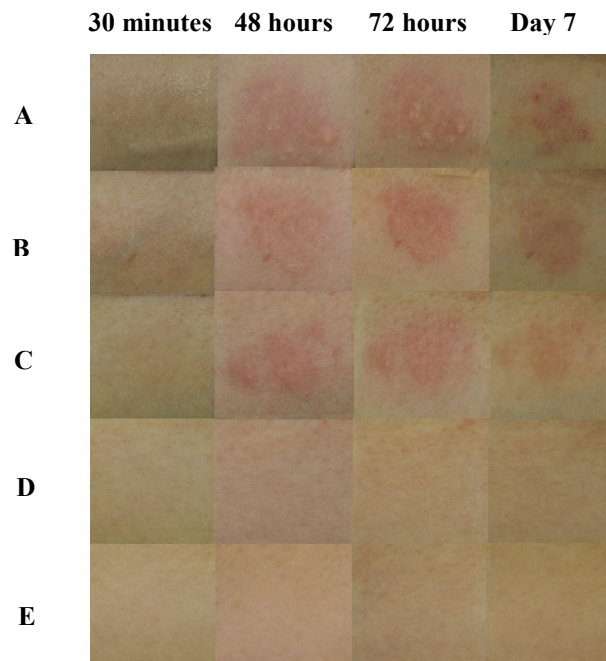
The aim of this pilot study was to investigate whether pretreatment of the skin with the astaxanthin can reduce the elicitation reaction to PPD in allergic subjects. We chose this contact allergen as a model because a well-characterized panel of subjects was available to us. For this study, it was necessary that all subjects had history of hair dye related skin complaints and positive skin reactions to a PPD containing hair dye. It is interesting that the grades of the current reactions to a hair dye PPD containing hair dye (Table 1, column 6, 9 and 12) are quite less to those after a similar exposure in the previous study a few years ago (Table 1, column 2).

Gold standard for identifying the cause of allergic contact dermatitis is patch test. This study applied the open-use test because we would like to practice in real situation. Therefore, the subjects were applied open patch test without occlusion on the volar side of forearm. Readings are made at regular intervals during the first 30-60 minutes after application, in order to detect immediate reactions [15]. The result showed that two subjects did not have reaction due to insufficient contact time and environmental exposure such as sun exposure, scratching.

The main finding of this study was insignificantly reduced elicitation reaction to PPD-containing hair dye when the skin was pretreated with the astaxanthin as compared with pretreatment with the vehicle alone ( $p = 1$ ) when the reaction was examined according to the conventional ICDRG criteria. As the number of participants in this study is low, and the effect of the antioxidant is not large, we consider that, in a similar study to the present one, a more expanded reading protocol should be used. This protocol should also focus on the size of the erythematous area, the number of papules, and the number of vesicles.

It is tempting to also examine the reduction in the elicitation reaction when the skin is not pretreated with anything versus when it is treated with antioxidant. While, this comparison encompasses the vehicle effect of the astaxanthin emulsion as additional variable. Nevertheless, this comparison showed no statistically significant reduction on the antioxidant emulsion-treated skin as compared with the skin that had been solely exposed to 1% PPD in petrolatum ( $p = 0.317$ ) at 72 hours (Table 1, column 9 versus column 10). No difference could be observed at 30 minutes, 48 hours, and on day 7.

The result showed that there was no statistically significant difference in the reduction of allergic response at the forearm skin. Although, a reduction in ICDRG scoring was not seen in every individual patch test reading on pretreated areas, this appeared to be more often attributable to a lack of gradation of the scoring range, with only three positive scores (+, ++, and +++) being permissible; in most cases there appeared to be an obvious trend towards reductions in reactions in the astaxanthin-pretreated sites (Figure 3).



**Figure 3** The elicitation reaction after pretreatment with or without astaxanthin emulsion. A. p-phenylenediamine (PPD) for 30 minutes; B. Emulsion with astaxanthin for 10 minutes followed by PPD for 30 minutes; C. Emulsion without astaxanthin for 10 minutes followed by PPD for 30 minutes; D. Emulsion with astaxanthin for 40 minutes; E. Emulsion without astaxanthin for 40 minutes. Reading will be performed at 30 minutes, 48 hours, 72 hours and on day 7 according to the conventional ICDRG criteria.

#### 4. Limitations

There were some limitations in our study. Firstly, the sample size was small, which results in the reduction of reaction of allergic contact dermatitis. The second limitation was area of patch test application which should applied close patch test under occlusion on the upper back should be applied because this area offers flat surface for good occlusion, and it is usually a large enough surface for application of the necessary number of patch test substances. Further, it is less often affected by skin diseases, and is not regularly exposed to the sun, and is less prone to scratching.

#### 5. Conclusions

Application of an astaxanthin emulsion seems not to reduce the allergenic response of the skin upon pretreatment with the astaxanthin.

#### 6. Acknowledgements

The authors would like to show our gratitude to Supitchaya Thaiwat, M.D. and Suwimon Pootongkam, M.D. for their assistance in providing useful comments during the course of this research, that the quality greatly improved the manuscript. Furthermore, we thank the clinic of Dermatology of Medicine at Thammasat University, Phramongkutklao Hospital and Thailand Tobacco Monopoly Hospital, Thailand for supporting participants and equipment during the research period.

## 7. References

1. Boonchai W, Bunyavaree M, Winayanuwattikun W, Kasemsarn P. Contact sensitizers in commercial hair dye products sold in Thailand. *Contact dermatitis*. 2016;74(4):222-9.
2. Fuchs J, Zollner TM, Kaufmann R, Podda M. Redox-modulated pathways in inflammatory skin diseases. *Free radical biology & medicine*. 2001;30(4):337-53.
3. Esser PR, Wolfe U, Durr C, von Loewenich FD, Schempp CM, Freudenberg MA, et al. Contact sensitizers induce skin inflammation via ROS production and hyaluronic acid degradation. *PLoS one*. 2012;7(7):e41340.
4. Byamba D, Kim TG, Kim DH, Je JH, Lee MG. The Roles of Reactive Oxygen Species Produced by Contact Allergens and Irritants in Monocyte-derived Dendritic Cells. *Annals of dermatology*. 2010;22(3):269-78.
5. Kim DH, Byamba D, Wu WH, Kim TG, Lee MG. Different characteristics of reactive oxygen species production by human keratinocyte cell line cells in response to allergens and irritants. *Experimental dermatology*. 2012;21(2):99-103.
6. Corsini E, Galbiati V, Nikitovic D, Tsatsakis AM. Role of oxidative stress in chemical allergens induced skin cells activation. *Food and chemical toxicology : an international journal published for the British Industrial Biological Research Association*. 2013;61:74-81.
7. Larbi A, Kempf J, Pawelec G. Oxidative stress modulation and T cell activation. *Experimental gerontology*. 2007;42(9):852-8.
8. Martin SF. New concepts in cutaneous allergy. *Contact dermatitis*. 2015;72(1):2-10.
9. Blokhina O, Virolainen E, Fagerstedt KV. Antioxidants, oxidative damage and oxygen deprivation stress: a review. *Annals of botany*. 2003;91 Spec No:179-94.
10. Yuan JP, Peng J, Yin K, Wang JH. Potential health promoting effects of astaxanthin: a high-value carotenoid mostly from microalgae. *Molecular nutrition & food research*. 2011;55(1):150-65..
11. Nishida Y, Yamashita E, Miki W. Quenching activities of common Hydrophilic and lipophilic antioxidants against singlet oxygen using Chemiluminescence detection system. *Car Sci*. 2007;11:16–20.
12. Lorenz RT and Cysewski GR: Commercial potential for Haematococcus microalgae as a natural source of astaxanthin. *Trends Biotechnol* 18: 160-167, 2000.
13. Coenraads PJ, Vogel TA, Blomeke B, Goebel C, Roggeband R, Schuttelaar ML. The role of the antioxidant ascorbic acid in the elicitation of contact allergic reactions to p-phenylenediamine. *Contact dermatitis*. 2016;74(5):267-72.
14. Lachapelle JM. A proposed relevance scoring system for positive allergic patch test reactions: practical implications and limitations. *Contact dermatitis*. 1997;36(1):39-43.
15. Johansen JD, Aalto-Korte K, Agner T, Andersen KE, Bircher A, Bruze M, et al. European Society of Contact Dermatitis guideline for diagnostic patch testing - recommendations on best practice. 2015;73(4):195-221.

# Efficacy of combining fractional carbon dioxide laser and silicone gel in treatment of hypertrophic scars and keloids

Thanakom Sukcharoen<sup>1,2</sup> and Suparuj Lueangarun<sup>1,\*</sup>

<sup>1</sup>Division of Dermatology, Chulabhorn International College of Medicine, Thammasat University, Amphur Klongluang, Pathumthani, Thailand 12120

<sup>2</sup>Pan Rajdhevee and Lion Supanhongsa Foundation, Bangkok, Thailand 10330

## Abstract

**Background:** Hypertrophic scars and keloids are common problems which impact the patients' quality of life. Intralesional steroid injection is the most widely used treatment for hypertrophic scars and keloids. However, the irreversible side effects from steroid injection could be skin atrophy, telangiectasia, and hypopigmentation.

**Objectives:** To evaluate the efficacies of combining ablative fractional carbon dioxide laser (AFCO2) and a film-forming liquid silicone gel (LSG) in treatment of hypertrophic scars and keloids.

**Methods:** This was a prospective, single (observer)-blinded, therapeutic trial. Twenty-four scars (8 hypertrophic scars and 16 keloids) from 15 subjects (mean  $\pm$  SD age of  $36.93 \pm 11.33$  years) were studied. All scars were treated with AFCO2 for 3 sessions at 30-day intervals (day 0, 30, and 60) and twice daily liquid silicone gel (LSG) for 90 days. Vancouver scar scale (VSS), patient and observer scar assessment scale (POSAS), and standardized photography were used for the evaluation of scar treatment efficacies on every visit (day 0, 30, 60 and 120). Hemoglobin and melanin index were analyzed using biometric assessment.

**Results:** The mean  $\pm$  SD scar duration was  $9.63 \pm 5.88$  years. There were 5 males and 10 females. Interestingly, the statically significant improvement of VSS and POSAS (both patient and observer scale) was exhibited after treatments. The biometric assessment revealed non-significant decrease of melanin level, but significant increase of hemoglobin index. No serious or irreversible adverse effects were present.

**Conclusions:** The combination of AFCO2 and LSG yielded a significant improvement following the clinical evaluation from both VSS and POSAS. Hence, this combination of treatment modality could be efficacious for hypertrophic scars and keloids.

**Keywords:** hypertrophic scar, keloid, fractional carbon dioxide laser, silicone gel, treatment

\*Corresponding author; e-mail address: saoraya180@gmail.com

## 1. Introduction

Hypertrophic scars and keloids are cutaneous lesions resulting from an excessive tissue response to dermal injury. Also, they are characterized by local fibroblast proliferation and overproduction of abnormal collagen. The lesions are common problems from various causes, such as burn injury, laceration, abrasion, surgery, vaccination, and spontaneous (in case of keloids) [1-3]. These types of abnormal scars may not only cause an aesthetic problem, but also are capable of affecting patients' quality of life with disturbing symptoms such as pruritus, pain, and contracture. As well, they could also dramatically affect patients' life, psychologically.

Failure at any stages of wound healing processes affects abnormal wound healing. Particularly, an excessive fibrotic response caused by an increased production of growth factors and a decreased metalloproteinase activity can lead to hypertrophic scars and keloids [2, 4].

Various treatment modalities have been used for treatment of both hypertrophic scars and keloids, such as intralesional steroids, surgical excision/revision, cryotherapy, pressure, intralesional 5-fluorouracil, radiation, and bleomycin injection. Intralesional corticosteroid injections are the most widely used modality for treatment of hypertrophic scars and keloids [1]. Its mechanism involves repressing of inflammation, inhibition of fibroblast proliferation, decrease of collagen and glycosaminoglycan synthesis, and inhibition of collagenase inhibitors [5, 6]. However, the side effects of steroid injections including skin atrophy, telangiectasia, and hypopigmentation are well documented [6]. Meanwhile, the success rate of this treatment modality is varied [7].

Currently, ablative fractional carbon dioxide laser (AFCO2) demonstrates the efficacies in treatment of hypertrophic scar and keloid following the improvement of subjective clinical grading and various scar scales, such as Vancouver scar scale (VSS) [8-11]. Moreover, recent studies showed the positive benefits of liquid silicone gel (LSG) in treatment of hypertrophic scars and keloids with improvement of many measurements including volume, hardness, redness, visual analog scale for pain and pruritus, VSS, patient and observer scar assessment scale (POSAS) [12, 13], and reduction in scar thickness [14].

It is hypothesized that these 2 treatment modalities could have synergistic effects from different mechanisms of actions in treatment of hypertrophic scars and keloids without any adverse effects from intralesional steroid injection. Therefore, we conducted a prospective, single (observer)-blinded, therapeutic trial to investigate the efficacies of combining AFCO2 and film-forming LSG in potential treatment of hypertrophic scars and keloids.

## 2. Research objective(s)

To evaluate the efficacies of combining AFCO2 and a film-forming LSG in treatment of hypertrophic scars and keloids.

## 3. Materials and methods

### 3.1 Subject population

The inclusion criteria included subjects aged 20 years and older, Fitzpatrick skin type III to IV, hypertrophic scars and keloids presentation for at least 6 months, and without any prior treatment during a period of at least 3 months. The exclusion criteria were pregnancy, breastfeeding, taking oral retinoid 6 months prior to treatment, active infection, or lesions suspicious for malignancy. The study protocol was approved by the Ethics Committee of Faculty of Medicine, Thammasat University, Thailand and conducted in accordance with the Declaration of Helsinki and Good Clinical Practice Guidelines.

### 3.2 Study Design

A prospective, single (observer)-blinded, therapeutic trial was conducted. Each subject received a course of 3 AFCO2 sessions at 30-day intervals (day 0, day 30, and day 60) combined with the twice-daily LSG application for 90 days. Anesthesia was achieved with a topical anesthetic cream containing lidocaine 2.5% and prilocaine 2.5% (EMLA™, AstraZeneca, Cambridge, UK) under occlusion for 45 minutes prior to laser procedure. AFCO2 treatments (eCO2, Lutronic Co., Ltd, Seoul, Korea) with the parameters of 120 µm spot size, pulse energies 70-90 mJ, peak power 30 W, total treatment density of 100 spot/cm<sup>2</sup> were performed for 2 passes by single physician. The film-forming LSG (Strataderm™, Stratphrama AG, Basle, Switzerland) was applied over laser-treated scars within 60 seconds after the laser session and covered by nonstick occlusive dressing (Tegaderm™, 3M Company, St Paul, Minnesota, USA) for 24 hours. Then, the subjects were instructed to apply LSG on the treated areas twice daily for 90 days.

### 3.3 Assessments

Clinical, photography, biometric and adverse effects were evaluated at every visit before AFCO2 treatment (at baseline, day 30, and day 60) and at day 120 (last follow-up). Photographs were obtained using a digital camera. VSS and POSAS were evaluated for clinical changes. Biometric assessment (Antera 3DTM, Miravex Limited, Dublin, Ireland) was used for the evaluation of hemoglobin (erythema) and melanin index.

### 3.4 Statistical analysis

Baseline data were presented as mean  $\pm$  SD. The clinical and biometric assessment was analyzed using repeated measures ANOVA. P-value  $< 0.05$  was considered as statistical significance.

#### 4. Results and discussion

##### 4.1 Results

Demographic data included 24 scars (8 hypertrophic scars and 16 keloids), mean  $\pm$  SD scar duration of  $9.63 \pm 5.88$  years, from 15 subjects (5 males and 10 females), mean  $\pm$  SD age of  $36.93 \pm 11.33$  years, were enrolled and completed the study.

Clinical assessment consisted of VSS, total POSAS (patient scale), and total POSAS (observer scale), which revealed a statistically significant improvement (Table 1) at baseline, day 30, day 60, and day 120, respectively. POSAS (patient scale) showed a statistically significant decrease in almost all parameters, including pain, itching, color, thickness, and texture (Table 2). Additionally, POSAS (observer scale) exhibited a statistically significant decrease in almost all parameters, including pigmentation, thickness, relief, pliability, and surface area (Table 3). Only some parameters showed a non-statistically significant decrease, including hardness (patient scale) and vascularity (observer scale). (Figure 1)

**Table 1** VSS and POSAS evaluation of hypertrophic scars and keloids treated with combination of treatments at baseline, day 30, 60 and 120, respectively

Clinical score (mean $\pm$ SD)	Baseline	Day 30	Day 60	Day 120	P-value
Vancouver score	$8.75 \pm 2.07$	$7.58 \pm 2.43$	$7.21 \pm 2.6$	$6.96 \pm 2.65$	$<0.001^{**}$
Total POSAS (patient)	$35.38 \pm 10.74$	$27.08 \pm 9.4$	$29.5 \pm 9.97$	$26.04 \pm 12.55$	$0.004^*$
Total POSAS (observer)	$38.33 \pm 8.36$	$35.71 \pm 8.23$	$33.54 \pm 9.15$	$32.13 \pm 8.42$	$<0.001^{**}$

VSS; Vancouver scar scale, POSAS; the patient and observer scar assessment scale, \*, P-value  $<0.05$ , \*\*, P-value  $<0.001$

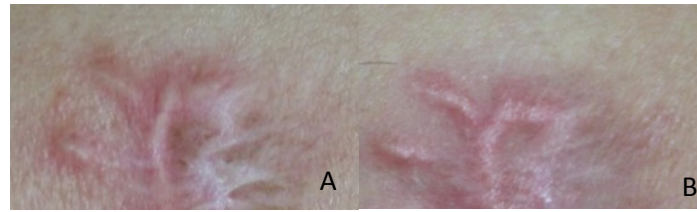
**Table 2** The parameters of the POSAS evaluated by subjects at baseline, day 30, 60 and 120, respectively

POSAS (patient scale) (mean $\pm$ SD)	Baseline	Day 30	Day 60	Day 120	P-value
Pain	$3.33 \pm 2.32$	$2.04 \pm 1.57$	$1.58 \pm 0.93$	$2.04 \pm 1.97$	$0.013^*$
Itching	$4.33 \pm 2.88$	$3.33 \pm 2.55$	$3 \pm 2.02$	$2.58 \pm 2.06$	$0.031^*$
Color	$6.83 \pm 1.95$	$5 \pm 2.65$	$6.63 \pm 2.39$	$6.17 \pm 2.76$	$0.034^*$
Thickness	$7 \pm 2.54$	$5.21 \pm 2.62$	$6 \pm 2.41$	$4.75 \pm 2.88$	$0.004^*$
Hardness	$6.79 \pm 2.34$	$5.46 \pm 2.54$	$5.96 \pm 2.77$	$5.29 \pm 3.17$	$0.152$
Texture	$7.08 \pm 2.48$	$6.04 \pm 2.42$	$6.33 \pm 2.53$	$5.21 \pm 2.7$	$0.022^*$

**Table 3** The parameters of the POSAS evaluated by observer at baseline, day 30, 60 and 120, respectively

POSAS (observer scale) (mean $\pm$ SD)	Baseline	Day 30	Day 60	Day 120	P-value
Vascularity	$6.21 \pm 1.91$	$6.25 \pm 2.07$	$6.5 \pm 2.25$	$6 \pm 2.48$	$0.321$
Pigmentation	$5.92 \pm 2.08$	$5.54 \pm 2.54$	$5 \pm 2.57$	$4.54 \pm 2.6$	$<0.001^{**}$
Thickness	$6.54 \pm 1.79$	$6.25 \pm 1.96$	$5.92 \pm 2.19$	$5.83 \pm 2.14$	$0.009^*$
Relief	$6.58 \pm 1.5$	$6.25 \pm 1.67$	$5.42 \pm 1.93$	$5.25 \pm 1.85$	$<0.001^{**}$
Pliability	$6.54 \pm 1.86$	$5.38 \pm 2.28$	$5.13 \pm 2.15$	$5.04 \pm 2.16$	$<0.001^{**}$
Surface area	$6.54 \pm 1.77$	$6.04 \pm 1.57$	$5.58 \pm 1.59$	$5.46 \pm 1.69$	$0.001^*$





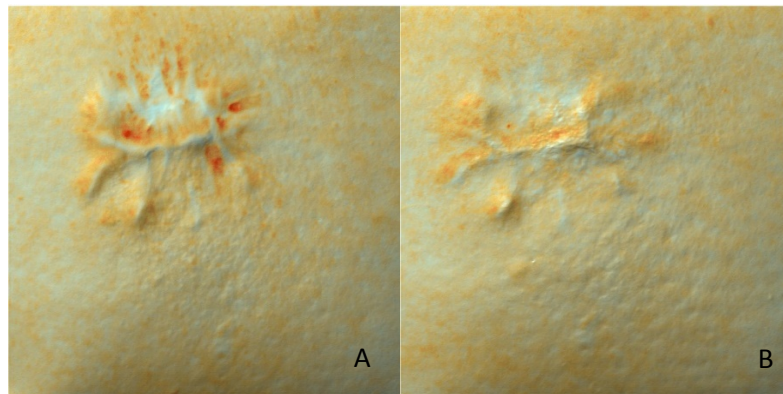
**Figure 1** Photographs showed clinical improvement of pigmentation and textural change after receiving a combination of AF<sub>CO</sub><sub>2</sub> and LSG treatments (A; baseline, B; Day 120).

For biometric assessment, hemoglobin index significantly increased from baseline to highest value at day 60 (last laser treatment), then declined at day 120 (last follow-up). The mean ± SD of hemoglobin levels at baseline, day 30, day 60, and day 120 were 1.82 ± 0.34, 1.93 ± 0.26, 1.99 ± 0.27, and 1.97 ± 0.2, respectively (P-value <0.001). Melanin level slightly decreased from baseline to minimum at day 120 (last follow-up), without statistical significance. The mean ± SD of melanin levels at baseline, day 30, day 60, and day 120 were 0.61 ± 0.07, 0.61 ± 0.07, 0.61 ± 0.06, and 0.6 ± 0.07, respectively (P-value = 0.449).

**Table 4** Biometric assessment of hypertrophic scars and keloids treated with combination of treatments at baseline, day 30, 60 and 120, respectively

Biometric assessment (mean ± SD)	Baseline	Day 30	Day 60	Day 120	P-value
Hemoglobin index	1.82 ± 0.34	1.93 ± 0.26	1.99 ± 0.27	1.97 ± 0.2	<0.001**
Melanin index	0.61 ± 0.07	0.61 ± 0.07	0.61 ± 0.06	0.6 ± 0.07	0.449

Whereas, adverse effects showed mild itching for a few days after laser treatment in 3 scars (12.5%). Other adverse events were post-inflammatory hyperpigmentation, persistent erythema, and increased elevation in 8.33%, 16.67%, and 4.16%, respectively.



**Figure 2** Biometric photography showed a decrease in melanin level after receiving a combination of AF<sub>CO</sub><sub>2</sub> and LSG treatment. (A; baseline, B; Day 120).

#### 4.2 Discussion

To the best of our knowledge, this is the first prospective trial evaluating the efficacies of combining AF<sub>CO</sub><sub>2</sub> and a film-forming LSG in treatment of hypertrophic scars and keloids over a period of 4-month follow-up. This study revealed a statistically significant improvement of hypertrophic scar and keloid from clinical assessment by VSS and POSAS. The efficacies of combining treatments could be elucidated by the mechanisms of AF<sub>CO</sub><sub>2</sub> and LSG in treatment of scars.

AF<sub>CO</sub><sub>2</sub> is one of the ablative fractional laser resurfacing (AFR) based on the principle of fractional photothermolysis. The laser ablates epidermis and heats dermal tissue by creating the zones called microscopic

treatment zones (MTZs), consisting of sharply columnar tissue denaturation that surrounded by viable tissue. Mechanism of AFCO<sub>2</sub> on hypertrophic scars and keloids includes the induction of remodeling effects, differentiation and migration of “niched” pilosebaceous melanoblasts, down-regulation of type I and III procollagen mRNA levels, down-regulation of TGF $\beta$ -2/3 production, and up-regulation of matrix metalloproteinase [7, 9]. Consequently, recent studies showed the effectiveness of AFCO<sub>2</sub> in treatment of hypertrophic scars and keloids following the improvement of subjective clinical grading and various scar scales such as VSS and POSAS [8-11].

Silicone is macromolecular structures composed of siloxane backbones with alkyl, aryl or organo-functional substitutions. In the medical and pharmaceutical industries, the term “silicone” typically encompasses materials based on dimethylsiloxane structure. Polydimethylsiloxanes are recognized for their biocompatibility and one of the most tested materials for their safety and efficiency in applications. Mechanism of silicone on hypertrophic scars and keloids includes the occlusion and hydration of stratum corneum, higher skin temperature, negative static electric field, increased production of basic fibroblast growth factor (bFGF), and down-regulating in the production of transforming growth factor beta2 (TGF- $\beta$ 2), leading to the improvement of hypertrophic scars and keloids [15-17]. Therefore, current studies showed the efficacies of LSG in treatment of hypertrophic scars and keloids following the improvement of many measurements (volume, hardness, redness, visual analog scale for pain and pruritus, VSS, POSAS [12, 13], and reduction in scar thickness [14].

Moreover, this study thoroughly evaluated the efficacies of combining AFCO<sub>2</sub> and LSG using both subjective clinical assessment (VSS and POSAS) and objective assessment (biometric assessment for hemoglobin and melanin index).

Throughout the study, there was a statistically significant decrease in VSS and total POSAS of both patient and observer scale. Moreover, POSAS (patient scale) showed a statistically significant decrease in almost all parameters (pain, itching, color, thickness, and texture). Also, POSAS (observer scale) revealed a statistically significant decrease in almost all parameters (pigmentation, thickness, relief, pliability, and surface area). Only some parameters demonstrated a non-statistically significant decrease, such as hardness (patient scale) and vascularity (observer scale). For vascularity, the observer scale showed scar redness that increased from baseline and reached maximum at day 60, possibly from inflammation caused by MTZ in AFCO<sub>2</sub>, then decreased to lower than baseline at day 120 from wound healing process.

Objective evaluation from biometric measurement also showed corresponding results with POSAS in term of hemoglobin and melanin index. Hemoglobin level increased from baseline to peak at day 60 (last laser treatment), then declined at day 120 (last follow-up), in accordance with the pattern of vascularity from observer POSAS. Melanin index slightly decreased from baseline to lowest point at day 120 (last follow-up), according to color and pigmentation from both patient and observer scales of POSAS.

In addition, no serious or irreversible complications like skin atrophy, telangiectasia, and hypopigmentation from intralesional steroid injection were observed throughout this study. Hence, these treatment options could be a promising modality for treatment of hypertrophic scars and keloid.

The limitation of this study included small sample size, location, type of scars, and no standardized laser parameter (such as number of sessions, wavelength, energy levels, and time intervals between treatments). Thus, the difference in tissue-reaction and remodeling would be presumed. Nonetheless, further studies with larger sample size and conducted as the split-lesion, randomized control trial to compare the efficacy of the combination of AFCO<sub>2</sub> and LSG with AFCO<sub>2</sub> alone in treatment of hypertrophic scars and keloids, should be recommended to elucidate the efficacies of these treatment combinations.

## 5. Conclusions

The combination of AFCO<sub>2</sub> and a film forming LSG yielded a significant improvement in clinical evaluation from both VSS and POSAS in treatment of hypertrophic scars and keloids with few adverse effects. Hence, this combination could be the efficacious treatment modality of hypertrophic scars and keloids.

## References

- [1] Gauglitz GG, Korting HC, Pavicic T, Ruzicka T, Jeschke MG. Hypertrophic Scarring and Keloids: Pathomechanisms and Current and Emerging Treatment Strategies. *Mol Med.* 2011; **17** (1-2): 113-25.
- [2] Sun BK, Siperashvili Z, Khavari PA. Advances in skin grafting and treatment of cutaneous wounds. *Science.* 2014; **346** (6212): 941-5.
- [3] Baker R, Urso-Baiarda F, Linge C, Grobelaar A. Cutaneous Scarring: A Clinical Review. *Dermatol Res Pract.* 2009; **2009**: 1-7.
- [4] Wolfram D, Tzankov A, Pulzl P, Piza-Katzer H. Hypertrophic scars and keloids--a review of their pathophysiology, risk factors, and therapeutic management. *Dermatol Surg.* 2009; **35** (2): 171-81.
- [5] Mari W, Alsabri SG, Tabal N, Younes S, Sherif A, Simman R. Novel Insights on Understanding of Keloid Scar: Article Review. *J Am Coll Clin Wound Spec.* 2015; **7** (1-3): 1-7.

- [6] Toro DD, Dedhia R, Tollefson TT, Del Toro D. Advances in scar management: prevention and management of hypertrophic scars and keloids. **Curr Opin Otolaryngol Head Neck Surg.** 2016; **24** (4): 322-9.
- [7] Meaume S, Le Pillouer-Prost A, Richert B, Roseeuw D, Vadoud J. Management of scars: updated practical guidelines and use of silicones. **Eur J Dermatol.** 2014; **24** (4): 435-43.
- [8] El-Zawahry BM, Sobhi RM, Bassiouny DA, Tabak SA. Ablative CO2 fractional resurfacing in treatment of thermal burn scars: an open-label controlled clinical and histopathological study. **J Cosmet Dermatol.** 2015; **14** (4): 324-31.
- [9] Qu L, Liu A, Zhou L, He C, Grossman PH, Moy RL, et al. Clinical and molecular effects on mature burn scars after treatment with a fractional CO(2) laser. **Lasers Surg Med.** 2012; **44** (7): 517-24.
- [10] Hultman CS, Edkins RE, Wu C, Calvert CT, Cairns BA. Prospective, before-after cohort study to assess the efficacy of laser therapy on hypertrophic burn scars. **Ann Plast Surg.** 2013; **70** (5): 521-6.
- [11] Waibel JS, Wulkan AJ, Shumaker PR. Treatment of hypertrophic scars using laser and laser assisted corticosteroid delivery. **Lasers Surg Med.** 2013; **45** (3): 135-40.
- [12] Grella R, Nicoletti G, D'Ari A, Romanucci V, Santoro M, D'Andrea F. A useful method to overcome the difficulties of applying silicone gel sheet on irregular surfaces. **Int Wound J.** 2015; **12** (2): 185-8.
- [13] Goldberg DJ. Efficacy and Safety of a Novel 100% Silicone Scar Gel Treatment for Early Intervention in Scar Management. **J Clin Aesthet Dermatol.** 2016; **9** (12): 13-20.
- [14] Lacarrubba F, Patania L, Perrotta R, Stracuzzi G, Nasca MR, Micali G. An open-label pilot study to evaluate the efficacy and tolerability of a silicone gel in the treatment of hypertrophic scars using clinical and ultrasound assessments. **J Dermatolog Treat.** 2008; **19** (1): 50-3.
- [15] Mustoe TA. Evolution of silicone therapy and mechanism of action in scar management. **Aesthetic Plast Surg.** 2008; **32** (1): 82-92.
- [16] Kuhn MA, Moffit MR, Smith PD, Lyle WG, Ko F, Meltzer DD, et al. Silicone sheeting decreases fibroblast activity and downregulates TGFbeta2 in hypertrophic scar model. **Int J Surg Investig.** 2001; **2** (6): 467-74.
- [17] Hanasono MM, Lum J, Carroll LA, Mikulec AA, Koch RJ. The effect of silicone gel on basic fibroblast growth factor levels in fibroblast cell culture. **Arch Facial Plast Surg.** 2004; **6** (2): 88-93.

# Stability Study of Prasaplai Capsule used for Clinical Efficacy Study in Postpartum Rehabilitation in Bang Pa In Hospital, PhraNakhon Si Ayutthaya

ChaisakThanonkaew<sup>1,\*</sup>, Lertchai Jitsaeree<sup>2</sup>, Suwanna Pahusachalak<sup>2</sup>, Suthima Sukreeket<sup>2</sup>, Jiraporn Muangpran<sup>2</sup>, Supaporn Pornpinatepong<sup>2</sup>, Bunleu Sungthong<sup>3</sup> and Pilanthana Lertsatitthanakorn<sup>1</sup>

<sup>1</sup>Master of Science Program in Thai Traditional Pharmacy, Faculty of Science and Technology, BansomdejchaoprayaRajabhat University

<sup>2</sup>Bang Pa-In Hospital, PhraNakhon Si Ayutthaya,

<sup>3</sup>Pharmaceutical Chemistry and Natural Product Research Unit, Faculty of Pharmacy, Mahasarakham University

## Abstract

Prasaplai capsule is a herbal drug in the National List of Essential Medicines. It has been used to cure gynaecology diseases such as decreasing dysmennorrhoea and stimulate the excretion of amniotic fluid in postpartum mother. Therefore, stability of Prasaplai capsule used for clinical efficacy study in postpartum rehabilitation in Bang Pa In hospital was carried out in this research. Prasaplai capsule was stored at room temperature and accelerated condition at 45 °C for 112 days. The amount of curcumin, a dominant marker in Prasaplai capsule, was determined at different period of time using UV-Visible spectrophotometry technique. At the 112<sup>nd</sup> day, the remaining curcumin contents in Prasaplai capsule were 97.69 % and 81.48 % for room temperature and accelerated condition, respectively. In conclusion, this research revealed that storage time and temperature have affected to the curcumin contents in Prasaplai capsule. However, Prasaplai capsule used in Bang Pa-In Hospital, PhraNakhon Si Ayutthaya has met the USP 34 requirement due to possessing a chemical stability at least approximately 4 months at room temperature.

**Keywords:** Prasaplai, Stability, Herbal medicine, Postpartum mother

## 1. Introduction

Prasaplai capsule is a herbal drug in the National List of Essential Medicines. This herbal recipe compose of 81 parts of *Zingiber Cassumunar Roxb.*, 1 part of flavourant namely camphor and 8 parts of each herb including *Citrus hystrix DC.*, *Acorus calamus L.*, *Allium sativum L.*, *Allium ascalonicum L.*, *Piper nigrum L.*, *Piper retrofractum Vahl.*, *Zingiber officinale Roscoe*, *Curcuma zedoaria Roscoe* and *Nigella sativa L.* [1]. Because of Prasaplai's hot taste, it can warm up the body, stimulate milk breast feeding and hence causing balance of the body. Moreover, Prasaplai is able to relax the uterus and reduce inflammation. Therefore, it has been used to cure gynaecology diseases such as decreasing dysmennorrhoea and stimulate the excretion of amniotic fluid in post partum mother. Prasaplai capsule has been used in post partum mother at Bang Pa In Hospital, PhraNakhon Si Ayutthaya for 4 years. Therefore, stability of Prasaplai capsule used for clinical efficacy study in postpartum rehabilitation in Bang Pa In hospital was carried out at room temperature and accelerated condition by using UV-Visible spectrophotometry technique.

## 2. Research objective

To determine the stability of Prasaplai capsule used for clinical efficacy study in postpartum rehabilitation in Bang Pa In Hospital, PhraNakhon Si Ayutthaya.

---

\* Corresponding author; e-mail: Chaisak\_t@hotmail.co.th

### 3. Materials and methods

#### Chemicals

- Ethanol (DUKSAN, Singapore)
- Curcumin (SIGMA, Singapore)

#### Instruments

- UV-Vis Spectrometer (Thermo Fisher, USA)
- Ultrasonic bath (BANDELIN, Germany)
- Incubator (Mettler, Germany)
- Volumetric flasks
- Centrifuge (Hettich, Germany)

#### Pharmaceutical product

Prasaplai capsule used in this study has been produced by Bangsai Hospital, PhraNakhon Si Ayutthaya. Each capsule contain 500 mg of crude drug.



**Figure 1** Prasaplai capsule 500 mg used in this study

#### Methods

The ambered glass bottles containing Prasaplai capsule were stored at room temperature and accelerated condition at 45 °C for 112 days [2]. Due to Plai occupied 50 % of Prasaplai capsule's weight and curcumin is the dominant marker found in Plai [3]. Curcumin has been used as standard in this study. At day 0, 14, 28, 56, 84 and 112, a suitable quantity of Prasaplai capsule kept at both conditions was random selected. The remaining curcumin in Prasaplai capsule was determined by UV-visible spectrophotometry modified from Thai herbal pharmacopoeias follow.

#### 1) Determination the standard curve of curcumin

Five concentrations of standard curcumin was performed as described in Table 1 [4].

**Table 1** Preparation of five concentrations of standard curcumin

Concentration	Preparation method
8 µg/ml (Stock solution)	a) 0.02 g of standard curcumin was weighed into 25 ml volumetric flask. 90% ethanol was added. Ultrasonic bath was used to stimulate the dissolution of curcumin for 10 minutes. Therefore, the resulting standard was clear, yellow solution and the concentration was 0.8mg/ ml of curcumin solution (solution "a" ) b) 0.5 ml of solution "a" was pipetted into 50 ml volumetric flask. 90% ethanol was then added that leading to 8 µg/ml of curcumin solution, denominated as "stock solution"
6 µg/ml	18.75 ml of stock solution was pipetted into 25 ml volumetric flask and adjusted to volume with 90% Ethanol.
4 µg/ml	12.50 ml of stock solution was pipetted into 25 ml volumetric flask and adjusted to volume with 90% Ethanol.
2 µg/ml	6.25 ml of stock solution was pipetted into 25 ml volumetric flask and adjusted to volume with 90% Ethanol.
0.8 µg/ml	2.50 ml of stock solution was pipetted into 25 ml volumetric flask and adjusted to volume with 90% Ethanol.

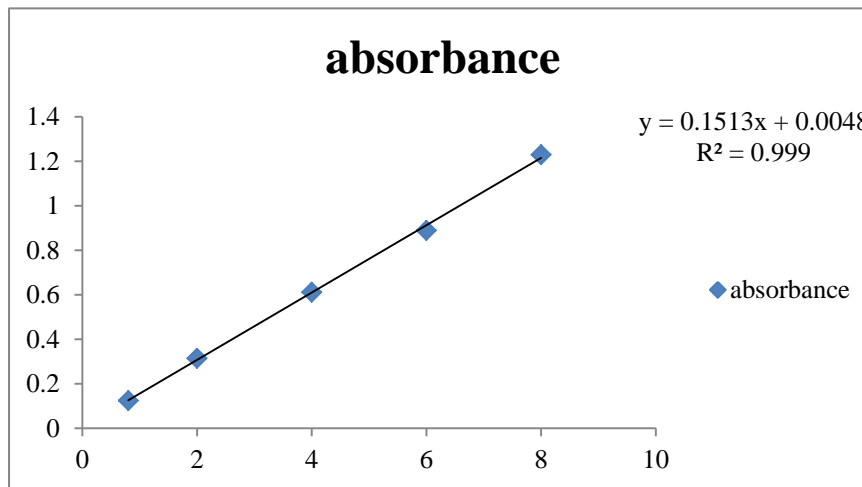
Five concentrations of standard curcumin shown in Table 1 were measured the absorbance using UV-visible spectrophotometer at 420 nm. Standard curve of curcumin was plotted between absorbance and concentration at day 0, 14, 28, 56, 84 and 112.

## 2) Determination the remaining curcumin in Prasapalai capsule kept at both conditions

At day0, 14, 28, 56, 84 and112, one capsule of Prasapalai stored at each condition was loosen into 25 ml volumetric flask. 90% ethanol was added to volume and mixed well. The ultrasonic bath was used to stimulate the dissolution of Prasapalai for 30 minutes that hence resulting to 0.02 g/ml sample solution. The sample solution was centrifuged at 2,000 xg for 15 minutes and the supernatant was collected for measuring an ansorbance by UV-visible spectrophotometer at 420 nm. The experiment was performed in triplicate for each storage condition and the absorbance was converted to remaining quantity of curcumin in Prasapalai capsule.

## 4. Results and discussion

After plotting between absorbance at 420 nm and concentration of standard curcumin at day0, 14, 28, 56, 84 and112, standard curve of curcumin and linear regression equation were accomplished. Therefore, remaining quantity of curcumin in Prasapalai capsule was calculated by replacing the absorbance in linear regression equation and solving this equation. For example, the remaining quantity of curcumin in Prasapalai capsule kept at (RT/ 45 C) at Day 14 was calculated as follow.



**Figure 2** Example Calculation the remaining quantity of curcumin in Prasapalai capsule at Day14(RT/ 45 C)

Linear regression equation

$$Y = \frac{0.1513x + 0.0048}{0.999}$$

Replacing Y with 0.308 (absorbance at 420 m)       $0.308 = \frac{0.1513x + 0.0048}{0.999}$

$$X = 2.00 = 1.25 \text{ mg} = \text{remaining quantity of curcumin in each prasapalai capsule}$$

Equivalence to percentage of remaining curcumin =  $\frac{\text{curcumin in Day14} \times 100}{\text{curcumin in Day0}}$

After calculation for all sampling days, the remaining quantity (mg) of curcumin and the percentage of remaining curcumin in Prasapalai capsule kept at both conditions were demonstrated in Table 2 and Table 3, respectively.

**Table 2** The remaining quantity of curcumin (mg) in 1 g of Prasaplai capsule

<b>Remaining quantity of curcumin (mg) (Mean ± SD)</b>			
<b>Day</b>	<b>Room Temperature</b>	<b>45 °C</b>	<b>P-value</b>
0	2.57 ± 0.02	2.57 ± 0.02	0.51 <sup>a</sup>
14	2.55 ± 0.02 (P=1.00) <sup>b</sup>	2.53 ± 0.05 (P=0.28) <sup>b</sup>	0.82 <sup>a</sup>
28	2.55±0.01 (P=0.28) <sup>b</sup>	2.41 ± 0.01 (P=0.10) <sup>b</sup>	0.05 <sup>a</sup>
56	2.55 ± 0.03 (P=1.00) <sup>b</sup>	2.20 ± 0.03 (P=0.10) <sup>b</sup>	0.05 <sup>a</sup>
84	2.52 ± 0.01 (P=0.10) <sup>b</sup>	2.16 ± 0.02 (P=0.10) <sup>b</sup>	0.05 <sup>a</sup>
112	2.51 ± 0.04 (P=0.10) <sup>b</sup>	2.10 ± 0.01 (P=0.10) <sup>b</sup>	0.05 <sup>a</sup>
Pearson Correlation	-0.651 (P=0.00) <sup>c</sup>	-0.954 (P=0.00) <sup>c</sup>	

<sup>a</sup>Mann-Whitney Test used for comparing between condition

<sup>b</sup>Wilcoxon Signed Ranks Test used for comparing between each day and day 0 (in the same condition)

<sup>c</sup>Pearson Correlation test used for determination the correlation between storage time and The remaining quantity of curcumin

According to Table 2, Prasaplai capsule kept for approximately 4 months has been revealed the decreasing of curcumin at both conditions. At day 112, the remaining quantity of curcumin per 1 g of Prasaplai capsule was 2.51 ± 0.04mg and 2.10 ± 0.01 mg at room temperature and 45 degree celcius, respectively. The statistics namely Mann-Whitney test has been indicated the difference between the remaining quantity of curcumin at both conditions ( $P < 0.05$ ) from day 28 to day 112. On the other hand, Wilcoxon Signed ranks statistic test indicated that the remaining quantity of curcumin at each sampling day did not differ from day 0 ( $P > 0.05$ ) for both conditions. In addition, Pearson Correlation statistical test indicated that the remaining quantity of curcumin in Prasaplai capsule has shown a medium correlation (Pearson correlation coefficient = -0.651) and high correlation (Pearson correlation coefficient = -0.954) to storage time on the opposite direction for room temperature and 45 degree celcius, respectively. Therefore, this phenomena has revealed the influence of storage temperature to the stability of crude drug.

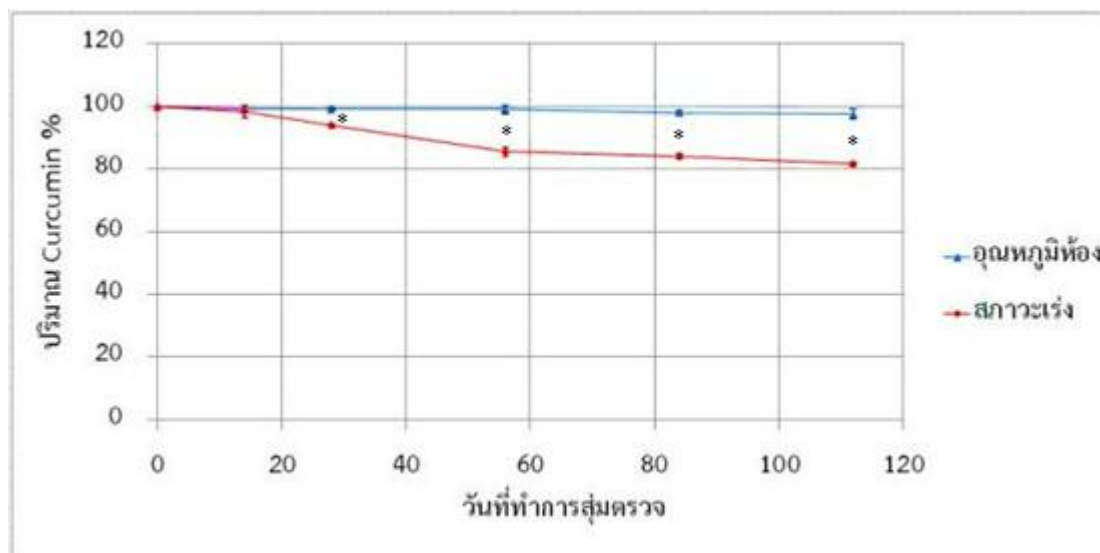
**Table 3** The percentage of remaining curcumin in Prasaplai capsule kept at both conditions in comparison with day 0

<b>Percentage of remaining curcumin (Mean ± SD)</b>								
<b>Day</b>	<b>0</b>	<b>14</b>	<b>28</b>	<b>56</b>	<b>84</b>	<b>112</b>		
Room temperature	100	99.26 ± 0.87	99.14 ± 0.38	99.07 ± 1.34	98.02 ± 0.60	97.69 ± 1.56		
45 degree celcius	100	98.42 ± 2.00	93.78 ± 0.61	85.44 ± 1.37	83.94 ± 0.87	81.48 ± 0.49		

Table 3 and Figure 3 illustrate the percentage of remaining curcumin in Prasaplai capsule stored at both conditions in comparison with day 0. At day 112, the percent remaining of curcumin was 97.69 and 81.48 at room temperature and 45 degree celcius, respectively (Table 3). Moreover, the percent remaining of curcumin at both conditions has demonstrated the statistical difference from day 28 to 112 (Figure 3).

According to USP 34, percentage labeled amount of active drug in the recipe should be in the range of 90-110 [5]. Thus, Prasaplai capsule stored at room temperature has possessed a chemical stability due to an acceptable percentage of curcumin (97.69 % – 100 %) during approximately 4 months of storage time. On the other hand, Prasaplai capsule stored at 45 degree celcius has shown a dramatically decreasing of curcumin content during approximately 4 months of storage time. At day 112, percentage of curcumin kept at this

condition was only 81.48, which did not meet the standard of USP 34. Our results revealed that the storage time and temperature have affected to curcumin quantity, a dominant marker found in Prasapalai capsule. Because, the curcumin content has gradually reduced at room temperature while it has dramatically decreased at 45 degree celcius. It might be caused by degradation of curcumin which was a heat-labile phytochemical substance [6],[7]. These findings have agreed with the previous researches of Kritsada Chakchai and Mongkolsil Boongen. Because, the mentioned research works had studied the stability of Prasapalai capsule under accerated condition and found that high temperature had influenced to the decreasing of active ingredients in Prasapalai capsule [8],[9].



**Figure 3** Percentage of remaining curcumin in Prasapalai capsule stored at both conditions in comparison with day 0.

\*The statistical difference between both conditions ( $P < 0.05$ )

## 5. Conclusions

Prasapalai capsule used for clinical efficacy study in postpartum rehabilitation in Bang Pa In Hospital, PhraNakhon Si Ayutthaya has met the USP 34 standard due to possessing a chemical stability at least approximately 4 months at room temperature. The high temperature has dramatically affected the stability of Prasapalai capsule and therefore, this herbal drug should be stored at room temperature.

## Acknowledgements

The authors kindly thank to the budget grant from Bang Pa In Hospital, PhraNakhon Si Ayutthaya including all staffs in the hospital who involved in this research. A grateful thank was given to Thai traditional program, BansomdejchaoprayaRajabhat University for supported materials and chemicals. In addition, the authors thank to lecturer SuparatDuanyai for advising about UV-vis spectrophotometer.

## References

- [1] Bureau of Drug control. Ministry of Public Health, Thailand. National List of Essential Medicines; 2012.
- [2] Tiziana M.G. Pecora. Preparation, characterization and photostability assessment of curcumin microencapsulated within methacrylic copolymers. Journal of Drug Delivery Science and Technology. 2016; (33) 88-97
- [3] Department of Medical Sciences, Ministry of Public Health, Thailand. Thai Herbal Pharmacopoeia volume I. Office of Notional Buddishm Press: Bangkok. 1998; page 51-56.
- [4] Somjai Kajorncheappunngam. The Effect of Temperature, Time and Solvent on an Extraction of Curcumin from Turmeric. KhonKaen University. KRU Engineering Journal Vol. 33 No. 3 (225-236) May – June; 2006.
- [5] Bureau of Drug and Narcotic, Ministry of Public Health, Thailand. USP 34; 2011.
- [6] Nualkaew S. Phytochemical and pharmacological studies of a thai traditional: prasapalai. A thesis submitted in partial fulfillment of the requirements for the degree of doctor of philosophy (pharmaceutical chemistry and phytochemistry). Mahidol University; 2004.



- [7] Parmapojn S. Standardization and Biological Activities of Prasaplai, a Thai Traditional Medicine. Mahidol University; 2008.
- [8] Kritsada Chakchai. Formulation and satisfaction assessment of Prasaplai in primary dysmenorrheal patient at primary care center. MAHASARAKHAM UNIVERSITY; 2008.
- [9] Mongkolsil Boongen. Study on Formulation and Stability Test of Prasaplai Extract Tablets and Capsules for Dysmenorrhea. Thammasat University; 2011.

# Effect of calcipotriol on UVB-induced MMP-9 in human skin: A pilot study

Sasipa Limpikirati<sup>1</sup>, Jitlada Meephansan<sup>1\*</sup>, and Saranyoo Ponnikorn<sup>2</sup>

<sup>1</sup>Division of Dermatology, Chulabhorn International College of Medicine Thammasat University, Bangkok, Thailand, 12120

<sup>2</sup>Chulabhorn International College of Medicine Thammasat University, Bangkok, Thailand, 12120

## Abstract

Ultraviolet B (UVB) irradiation plays a key role in skin damage, which induces oxidative and inflammatory damages, thereby causing photoaging or photocarcinogenesis. It induces the expressions of matrix metalloproteinases (MMPs) and extracellular matrix degrading enzymes. MMP-9 not only acts as a main role for fibrillary collagen degradation leading to photoaging, but MMP-9 also promotes the transforming growth factor- $\beta$  and vascular endothelial growth factor leading to photocarcinogenesis.

Calcipotriol is a synthetic analogue of 1,25-dihydroxyvitamin D<sub>3</sub> which has potent cell regulating properties. There are many reports about in vitro vitamin D-mediated regulation of MMP-9 such as human prostate cancer cells, human uterine fibroid cells, human lung fibroblasts, human nasal polyp-derived fibroblasts and human squamous cell carcinoma cell line.

In this study, we used MMP-9 as a key marker, indicating photoaging and photocarcinogenesis, and test whether topical calcipotriol can prevent UVB-induced MMP-9. If calcipotriol can suppress UVB-induced MMP-9 level, it could have a probability to protect against photodamage.

Five healthy Thai volunteers were applied calcipotriol ointment for three consecutive days with 24 hours apart. Narrowband UVB-irradiation was administered to lower back skin including left side for calcipotriol's area and right side for normal skin. Twenty-four hours after irradiation, skin was biopsied for RT-PCR.

The results show that UVB irradiation caused an insignificant increase in MMP-9 mRNA level for  $0.208 \pm 0.25\%$  (p-value = 0.144). Calcipotriol reduced MMP-9 mRNA expression but not significant (p-value = 0.345).

Our pilot study demonstrates that topical calcipotriol had a trend to provide protection against UVB-induced MMP-9 which like potential abilities to prevent and treat photoaging and photocarcinogenesis. However, for limited numbers of subjects, the results cannot reach statistical significant. Further studies are necessary to confirm and expand these findings.

**Keywords:** Calcipotriol, MMP-9, matrix metalloproteinase, photoaging, photocarcinogenesis

## 1. Introduction

Skin damage can be caused by ultraviolet (UV) irradiation both directly and chronically. Amaro-Ortiz, A. *et al.* said that UV can cause acute effect such as erythema, sunburn and repeated effect like photoaging and skin tumors [1]. UV irradiation induces the matrix metalloproteinases' (MMPs) and inflammatory cytokines' expression. These pathways have a role in extracellular matrix degradation, oxidative stress induction. These processes lead to photoaging. Moreover, it also induces inflammatory responses, alterations in cell cycle progression, DNA damage and suppression of immune responses, all of which have been implicated in the development of skin cancers [2].

Quan T *et al.* reviewed that UV irradiation up-regulates the expression of MMP-1 which stimulates the degradation of collagen type I and III. MMP-9 further decomposes collagen fragments, and MMP-3 degrades collagen type IV and activates pro-MMP-1 [3].

MMPs are a family of zinc-dependent endopeptidases which have function in extracellular matrix

---

\*Corresponding author; e-mail: kae\_mdcu@yahoo.com

degradation. These functions are relating to destructive processes such as inflammation, tumor invasion and skin aging [4]. The combined actions of MMP-1, 3, and 9 degrade most of type I and III dermal collagen. With repeated sun exposure, the degraded collagen accumulates over time resulting in the clinical and histologic features of photoaging.

MMP-9 is a 92-kDa gelatinase (gelatinase-B), also called 92 kDa type IV collagenase. MMP-9 is produced by keratinocytes. MMP-9 acts as a key role in the final stage of fibrillar collagen degradation after initial cleavage by collagenases leading to photoaging [5]. It can digest collagen type IV, an important component of the basement membrane in skin which is crucial for epidermal integrity. It is also important in controlling epidermal differentiation. Because of its proteolytic activity against the basement membrane components [6]. MMP-9 promotes the release of transforming growth factor- $\beta$  and vascular endothelial growth factor leading to tumor invasion and angiogenesis [7,8].

Calcipotriol is a synthetic analogue of 1,25-dihydroxyvitamin D<sub>3</sub>. It functions as a cell regulator with fewer calcium-related side effects [9, 10]. In the skin, vitamin D<sub>3</sub> has several well-recognized biological activities such as an anti-proliferation, anti-differentiation, anti-inflammatory effect, anti-cancer, and immunomodulatory effect [11,12]. Various in vitro studies reported about the link of vitamin D<sub>3</sub> analogue and the decrease of MMP-9 in many types of cells not only in non-skin cells such as human prostate cancer cells [13,14], human uterine fibroid cells [15], human lung fibroblasts [16], human nasal polyp-derived fibroblasts [17] but also in human squamous cell carcinoma cell line [18]. There are also reports both in vitro [19] and in vivo murine model [20] showing that 1,25-dihydroxyvitamin D<sub>3</sub> have photoprotective effects to reduce skin cell apoptosis after UV radiation and also reduce a major form of DNA damage, cyclobutane pyrimidine dimer (CPD) formation.

In this study, we conducted with the purpose of exploring the use of calcipotriol, vitamin D<sub>3</sub> analogue, as a potential therapeutic agent for photoaging and photocarcinogenesis. Because the expression of MMP-9 has been associated with photo-related skin changes and skin cancer invasion, we thus set out to explore the presence of transcripts from these genes in irradiated human skin in order to investigate calcipotriol's effect on the expression of MMP-9 in healthy human's skin biopsies before and after UVB irradiation.

## **2. Research objective(s)**

To investigate the effect of calcipotriol on expression of UVB-induced MMP-9 mRNA in human skin

## **3. Materials and methods**

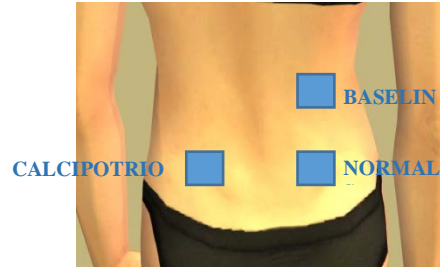
### **Subjects**

This study was approved by our institutional review board, and informed consent was obtained from all subjects prior to study. Five subjects (2 men and 3 women; ages 20 - 60 years; Fitzpatrick skin types III - IV) without current or prior skin disease, were studied for the effect of calcipotriol on acute UV response.

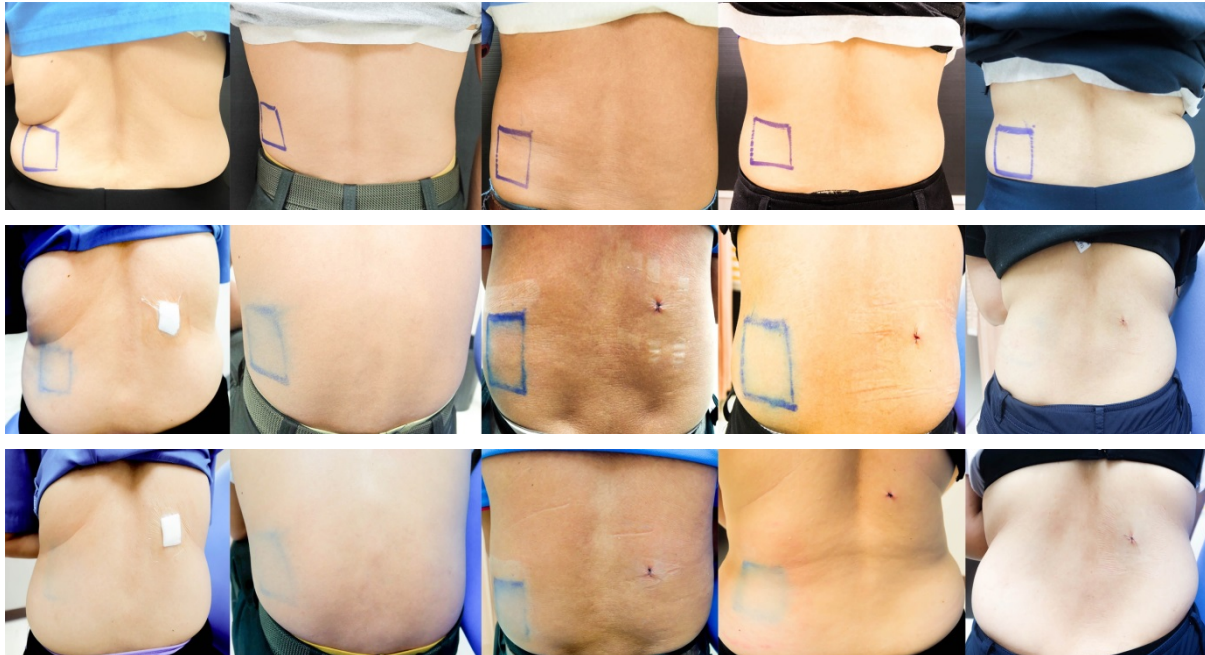
Exclusion criteria included pregnancy or lactation; smoking; any infectious skin disorders or any other skin lesions at the lower back area; photoallergic or photosensitive skin; concurrent use of any oral medication/immunosuppressant/antioxidant or any topical corticosteroid/retinoid use at lower back area within the previous three months; use of medical treatments for the skin for anti-aging (such as laser, phototherapy, chemical peels, or other therapies) at lower back area within six months prior to or during the study period; systemic steroid or vitamin intake within 1 month prior to enrollment; history of serious renal or hepatic dysfunction and chronic disease such as asthma, diabetes, and hypertension; history of skin cancers; sunbed use or sunbathing in the previous 3 months; immunocompromised host; hypersensitivity to calcipotriol; patients receiving treatment with vitamin D or calcium, phosphate, or other drugs that might influence calcium metabolism; allergic reaction to occlusive tape.

### **Topical application of calcipotriol**

On first day, for two sites (4 x 4 cm in size) at lower back area will be marked of each subject as figure 1. Each of calcipotriol ointment (50 ug/g) (Daivonex ointment: LEO Pharma AS, Denmark) will be applied daily with the amount 1.35 gm of each application for 3 consecutive days with 24 hours apart on the assigned site. Another site in figure 1 called as baseline site was biopsied since first day of study (before UV irradiation). During day 1 to day 3, all volunteers were tested as figure 2.



**Figure 1** Example of marked test sites at lower back area



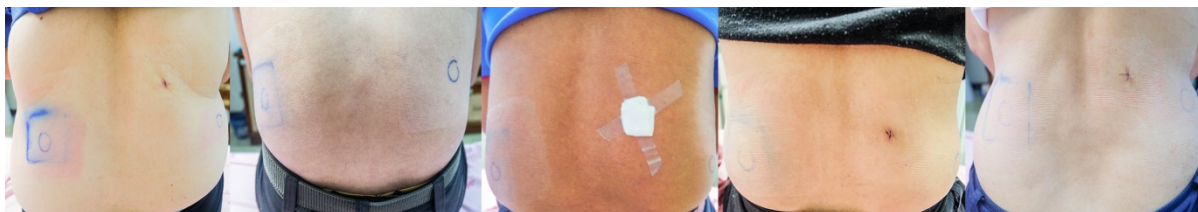
**Figure 2** Test performing in 5 volunteers during day 1 to day 3

On Day 4, after applied topical calcipotriol completely in 3 days, the two test sites were exposed with narrowband UV-B irradiation. All volunteers' body were global coverage. Only tested sites were exposed to narrowband UVB-irradiation. (figure 3).



**Figure 3.** Each volunteers' body were fully covered by shirt. Only two sites were exposed to narrowband UVB-irradiation.

On Day 5, 4-mm punch biopsies were collected from the two sites (one for calcipotriol treated sites and another for normal skin controlled sites) from each subject. Biopsy specimens will be processed for RT-PCR for MMP-9 measurement.



**Figure 5.** The lower back skin of every volunteers post radiation for 24 hours.

### **UV irradiation**

Narrowband UVB (NB-UVB) irradiation was administered to the lower back area including left side for calcipotriol's area and normal skin using a Waldmann UV-182 (Waldmann, Villingen-Schwenningen, Germany) phototherapy device fitted with Philips TL01-36W fluorescent lamps with an emission spectrum between 310 and 315 nm, with a peak at 312 nm dose 1,000 mJ/cm<sup>2</sup>.

### **Quantitative real-time RT-PCR**

Total RNA was isolated and purified from skin tissue sample using RNeasy® Mini Kit (QIAGEN, Valencia, California, USA). The cryopreserved tissues were ground into small pieces, lysed, and homogenized with 600 µL RNeasy lysis buffer. After adding ethanol, 700 µL of sample was transferred with any precipitate into the provided RNeasy spin column placed in a 2 mL collection tube. Finally, after spinning and washing, total RNA was eluted. A NanoDrop spectrophotometer (Thermo Fisher Scientific Incorporation, Massachusetts, USA) were used to determine the quantity and purity of RNA.

Total RNA was reverse-transcribed using a QuantiNova Probe RT-PCR Kit (Qiagen, Valencia, California, USA). According to the manufacturer's instructions, the reaction mixture contained 2× probe RT-PCR master mix (10 µL), QN probe RT mix (0.2 µL), primer MMP-9 (1 µL), primer GAPDH (1 µL), RNA (5 ng), and RNase-free water. The prepared reaction was placed in a C1000 Touch™ thermal cycler BIO-RAD CFX96™ Real-Time System (Bio-Rad, Hercules, California, USA), which was programmed as follows: 95 °C for 10 min, 40 cycles of 95 °C for 15 s, and 60 °C for 1 min. The relative ratio of gene expression for each gene was determined using standard exponential curves.

### **Statistical analysis**

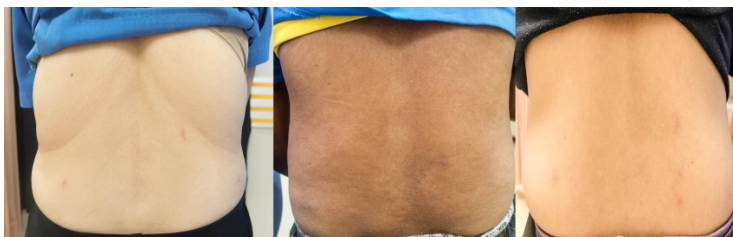
Results were recorded as mean and 95% Confident interval. The expression's levels of MMP-9 between pre and post UVB's results presented as median difference and Interquartile range. *P*-value corresponds to Wilcoxon signed-rank test and *P*-value of less than 0.05 was considered statistically significant.

## **4. Results and discussion**

### **Clinical evaluation**

During study, some subjects (three from five) complained of irritation at the topically tested sites. All patients completed the study; the treatment was well tolerated without adverse effects.

We followed up all subjects at 3 months after finished the study. No one has discovered any kinds of side effect (eg. erythema, prolonged irritation or excoriation) from applying topical calcipotriol occlusive for 3 consecutive days. There were only sutured scar one stitches for each site as shown in figure 5.



**Figure 5.** This figure shows three volunteers' lower back area for three months after study. All volunteer claimed that no side effects happened

**Molecular evaluation**

Broadband UVB irradiation has been shown to induce MMPs both in vitro and in vivo studies [4, 12]. However, there were few studies tested with narrowband UVB irradiation [13]. This pilot study was the first in vivo study to test the effects of on narrowband UVB-induced MMP-9 and to investigate whether topical calcipotriol have effect to suppress UVB-induced MMP-9 in human model.

The lower backs from five subjects were applied with calcipotriol at one site for three consecutive days. After that the lower back skins at treated site and normal skin’s site were irradiated with narrowband UVB (1 J/cm<sup>2</sup>). Twenty-four hours after UV irradiation, by RT-PCR, we observed the levels of UVB-induced MMP-9. It turned out that 3 of 5 volunteers got an increase of MMP-9 after UVB-irradiation in normal skin (table 1, figure 6). *P*-value = 0.144) (table 3, figure 7).

Next, we demonstrated that topical calcipotriol prevented UV-induced expressions of MMP-9 mRNA compared with UV-irradiated normal skin by 0.17%, *P*-value = 0.345 (table 3).

Interestingly, we found that one subjects got UV-induced MMP-9 mRNA level at calcipotriol’s site lower than his baseline MMP-9 mRNA level. In this subject, levels of MMP-9 between pre and post UV-induced MMP-9 at normal skin were in the same level (table 1 and figure 6). This data might suggest this subjects could previously have prolonged UV exposure. However, calcipotriol still had an effect to suppress MMP-9 level.

These results supports existing literature in the sensethat caalcipotriol may have the potential to be anti-photoaging agents and preventive form of photocarcinogenesis.

However, there was quite small number of volunteers in this pilot study. So, it might be a reason that the results cannot reach statistical significant. Additional studies in this field are necessary to confirm and expand these findings with larger sample size and to investigate other biomarkers relate to UVB-mediated pathology. Potentially, we can get more benefits from this drug for the prevention and treatment in many fields.

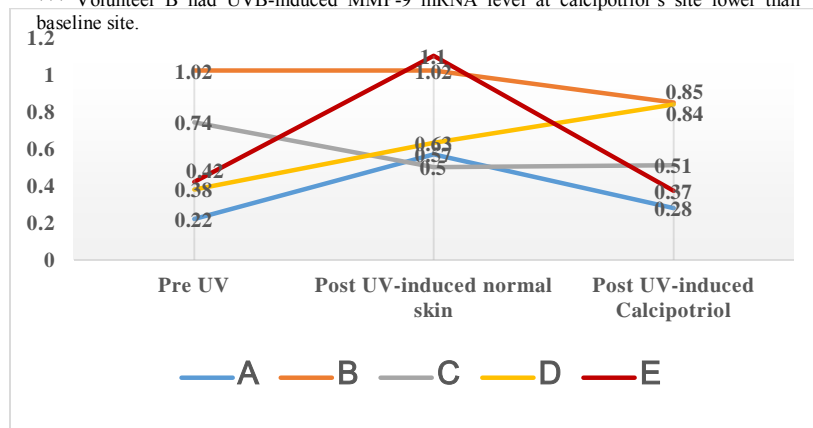
**Table 1** Levels of MMP-9 at pre and post UVB-induced with calcipotriol and normal skin

MMP-9/GAPDH ID	Pre UV	Post UV-induced normal skin	Post UV-induced Calcipotriol
A	0.22	0.57	0.28
B	1.02	1.02	0.85
C	0.74	0.5	0.51
D	0.38	0.63	0.84
E	0.42	1.1	0.37

\* 3 of 5 volunteers (A, D and E) had an increase of MMP-9 after UVB-irradiation in normal skin.

\*\* 3 of 5 volunteers (A, D and E) had UVB-induced MMP-9 level at calcipotriol’s site lower than baseline site. Volunteer C had UVB-induced MMP-9 level almost the same at both sites.

\*\*\* Volunteer B had UVB-induced MMP-9 mRNA level at calcipotriol’s site lower than baseline site.



**Figure 6** Levels of MMP-9 at pre and post UVB-induced with calcipotriol and normal skin

**Table 2** Mean and 95% Confident interval for preliminary results (n=5)

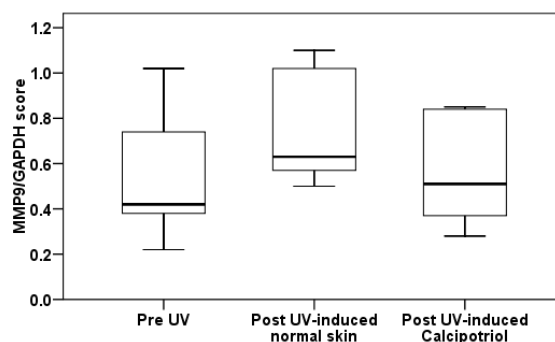
MMP9/GAPDH score	Mean (95%CI)
Pre UV	0.556 (0.157, 0.955)
Post UV-induced normal skin	0.764 (0.421, 1.107)
Post UV-induced calcipotriol	0.57 (0.242, 0.898)

Values presented as mean and 95% Confident interval.

This table shows the mean score with 95% CI of MMP-9/GAPDH score from Pre UV, Post UV-induced calcipotriol's site and Post UV-induced normal skin site.

\* MMP-9/GAPDH score in Pre UV was the lowest.

\*\* MMP-9/GAPDH score in Post UV-induced calcipotriol's site was lower than Post UV-induced normal skin site.

**Figure 7** Scatter plot for MMP9/GAPDH score**Table 3** Comparison: preliminary results

	Median difference (IQR)	p-value
Pre UV vs. Post UV-induced Calcipotriol	-0.05 (-0.17, 0.06)	0.893
Pre UV vs. Post UV-induced normal skin	0.25 (0, 0.35)	0.144
Post UV-induced Calcipotriol vs. Post UV-induced normal skin	-0.17 (-0.29, 0.01)	0.345

Values presented as median difference and Interquartile range. P-value corresponds to Wilcoxon signed-rank test.

This table shows the median difference with IQR of MMP9/GAPDH score between each two groups, indicating in the first column.

\* MMP-9/GAPDH score in Post UV-induced calcipotriol's site was lower than Post UV-induced normal skin site for 0.17 ( $P$ -value = 0.345).

## 5. Conclusions

Our study reveals that calcipotriol had a trend of protective effect on UVB-induced MMP-9 in a pilot study of human model. Additional studies in this field are necessary to confirm and expand these findings.

## Acknowledgements

This work was supported by Division of dermatology Chulabhorn International College of Medicine.

## References

1. Amaro-Ortiz A, Yan B, D'Orazio JA. Ultraviolet radiation, aging and the skin: prevention of damage by topical cAMP manipulation. *Molecules*. 2014;**19**(5):6202-19.
2. Pittayapruek P, Meephansan J, Prapapan O, Komine M, Ohtsuki M. Role of Matrix Metalloproteinases in Photoaging and Photocarcinogenesis. *Int J Mol Sci*. 2016;**17**(6).
3. Quan T, Qin Z, Xia W, Shao Y, Voorhees JJ, Fisher GJ. Matrix-degrading metalloproteinases in photoaging. *J Invest Dermatol Symp Proc*. 2009;**14**(1):20-4.
4. Chung JH, Seo JY, Lee MK, Eun HC, Lee JH, Kang S, et al. Ultraviolet modulation of human macrophage

- metalloelastase in human skin in vivo. **J Invest Dermatol.** 2002;**119(2)**:507-12.
5. Ahmed Haji Omar A, Haglund C, Virolainen S, Hayry V, Atula T, Kontio R, et al. MMP-7, MMP-8, and MMP-9 in oral and cutaneous squamous cell carcinomas. **Oral Surg Oral Med Oral Pathol Oral Radiol.** 2015;**119(4)**:459-67.
  6. Jung SK, Lee KW, Kim HY, Oh MH, Byun S, Lim SH, et al. Myricetin suppresses UVB-induced wrinkle formation and MMP-9 expression by inhibiting Raf. **Biochem Pharmacol.** 2010;**79(10)**:1455-61.
  7. Chang C, Werb Z. The many faces of metalloproteinases: cell growth, invasion, angiogenesis and metastasis. **Trends Cell Biol.** 2001;**11(11)**:S37-43.
  8. Kessenbrock K, Plaks V, Werb Z. Matrix metalloproteinases: regulators of the tumor microenvironment. **Cell.** 2010;**141(1)**:52-67.
  9. Bleiker TO, Bourke JF, Mumford R, Hutchinson PE. Long-term outcome of severe chronic plaque psoriasis following treatment with high-dose topical calcipotriol. **Br J Dermatol.** 1998;**139(2)**:285-6.
  10. Berth-Jones J, Hutchinson PE. Vitamin D analogues and psoriasis. **Br J Dermatol.** 1992;**127(2)**:71-8.
  11. Bikle DD. Vitamin D and the skin. **J Bone Miner Metab.** 2010;**28(2)**:117-30.
  12. Kim JS, Jung M, Yoo J, Choi EH, Park BC, Kim MH, et al. Protective Effect of Topical Vitamin D3 against Photocarcinogenesis in a Murine Model. **Ann Dermatol.** 2016;**28(3)**:304-13.
  13. Bao BY, Yeh SD, Lee YF. 1alpha,25-dihydroxyvitamin D3 inhibits prostate cancer cell invasion via modulation of selective proteases. **Carcinogenesis.** 2006;**27(1)**:32-42.
  14. Tokar EJ, Webber MM. Cholecalciferol (vitamin D3) inhibits growth and invasion by up-regulating nuclear receptors and 25-hydroxylase (CYP27A1) in human prostate cancer cells. **Clin Exp Metastasis.** 2005;**22(3)**:275-84.
  15. Halder SK, Osteen KG, Al-Hendy A. Vitamin D3 inhibits expression and activities of matrix metalloproteinase-2 and -9 in human uterine fibroid cells. **Hum Reprod.** 2013;**28(9)**:2407-16.
  16. Kim SH, Baek MS, Yoon DS, Park JS, Yoon BW, Oh BS, et al. Vitamin D Inhibits Expression and Activity of Matrix Metalloproteinase in Human Lung Fibroblasts (HFL-1) Cells. **Tuberc Respir Dis (Seoul).** 2014;**77(2)**:73-80.
  17. Wang LF, Tai CF, Chien CY, Chiang FY, Chen JY. Vitamin D decreases the secretion of matrix metalloproteinase-2 and matrix metalloproteinase-9 in fibroblasts derived from Taiwanese patients with chronic rhinosinusitis with nasal polyposis. **Kaohsiung J Med Sci.** 2015;**31(5)**:235-40.
  18. Meephanan J, Komine M, Tsuda H, Ohtsuki M. Suppressive effect of calcipotriol on the induction of matrix metalloproteinase (MMP)-9 and MMP-13 in a human squamous cell carcinoma cell line. **Clin Exp Dermatol.** 2012;**37(8)**:889-96.
  19. Wong, G., et al., 1,25-Dihydroxyvitamin D and three low-calcemic analogs decrease UV-induced DNA damage via the rapid response pathway. **J Steroid Biochem Mol Biol,** 2004. **89-90(1-5)**: p. 567-70.
  20. Dixon, K.M., et al., Skin cancer prevention: a possible role of 1,25dihydroxyvitamin D3 and its analogs. **J Steroid Biochem Mol Biol,** 2005. **97(1-2)**: p. 137-43.



# Session of Nursing

# The Humanized Care Behaviors among Nursing Students Studying at Boromarajonani Nursing College, Thailand

Thassanee Thipsungnoen<sup>1,\*</sup> and Praphaphorn Suemram<sup>1</sup>

<sup>1</sup>Boromarajonani College of Nursing, Nakhorn Ratchasima 30000, Thailand

## Abstract

This exploratory descriptive study aimed to identify the levels of humanized care behaviors according to the perception of the 3<sup>rd</sup> and the 4<sup>th</sup> year of the undergraduate nursing students and to test the differences among three domains of humanized care behaviors reported by those two nursing student groups. The Identities of Nursing Student Questionnaire which was adopted from Kittiporn Nounsuwan (2015) was applied for collecting data. Content validity of this questionnaire was approved by 3 experts. Cronbach's Alpha Coefficient for reliability was .96. The 96 samples were randomly selected from 186 population. The return rate of questionnaire was 100 %. Descriptive statistics and Independent t-test were used for data analysis.

The results revealed that the overall scores of humanized care behaviors of participants from the 3<sup>rd</sup> and the 4<sup>th</sup> year were at high level. There was no statistically significant difference between those two overall scores. The highest average scores of each domains (service mind, participation, and analytical thinking) for those two groups of participants were at high level. There were no statistically significant differences in service mind and analytical domains between those two groups of participants. However, those two groups of participants identified the difference on participation domain at a statistically significant level of .05.

**Keywords:** humanized care behavior, nursing student, service mind, analytical thinking, participation

## 1. Introduction

Today's technology has evolved very rapidly, bringing benefits to the area of health, but it is not always accompanied by respect, interaction, and empathy for others. In the hospital or healthcare service setting, the concept of humanization has become necessary in healthcare since some factors, such as the hospital or healthcare service routines, the advances of medical technology, and to a certain extent, the team paternalism tend to limit healthcare to the application of technical procedures with medical aims, resulting disadvantageous to patient autonomy. Some of the premises of the humanized healthcare are the perception of the human being as a bio-psycho-social and spiritual being and his essence and individuality should be respected. The respect towards the patient and the Principlialist Bioethics principles, autonomy, beneficence, nonmaleficence, and justice ground the search for humanized care [1].

Praboromarajchanok Institute for Health Workforce Development (PIHWD), Ministry of Public Health, Thailand, describes the identity of their nursing students as "providers of healthcare services with humanized care" which means that graduated nurses from Boromarajonani College of Nursing under PIHWD will provide friendly service with love and compassion. Based on the definition of this identity, not only the

---

\* Corresponding author; e-mail: tussanee@knc.ac.th

health problem, but also the suffering happen with the clients will be taken into the consideration. The PIHWD defines the identity of their nursing students within three key domains for humanized care, which are service minded (S), analytical thinking (A), and participation (P) or SAP [2].

Service minded is considered to be providers of friendly service delivered with love and compassion. Three characteristics of service minded are addressed. The first one provides the health service with a sense of willingness to help the clients based on their needs and accept, without any bias or any judgment on the attitudes, behaviors, and identity of the clients. The next one provides the health services without the need for incentive or any rewards or without conflicts of interest. The last one provides the health service based on the problem and needs of the majority and pays much attention to the client health problems and suffering [2, 3].

Analytical thinking is the ability of thinking based on a variety of resources and ability to analyze problems and needs of the clients critically. The implementation of clients' data through interventions that are related to the circumstances to their life is the essence of analytical thinking. Six characteristics of analytical thinking are addressed. The first one understands the real life situations and generates interventions to adopt in various settings. The second one uses the learning process and the continuous thinking process to collect data systematically. The third one analyzes health problems and the needs of clients based on their circumstances. The next one is the knowledge application to implement the interventions, which relies on the needs and condition of clients. After that set up a plan for health services that consider the daily activities of clients. The last one is competency development without boundary and does not rely on any theory or experiences [2, 3].

Participation in the health services is the last category of identity of humanized care. In doing this, students have to provide health services concerning individuality, condition, potential of the client and other factors that relate to the health status of clients. In addition, students should select knowledge and interventions that are appropriate to the preferences of clients. These interventions should be easy for students to implement. Moreover, interventions should have an effect on enhancing self-reliance among the clients. Therefore, participants in any interventions should have the right to make their own decision. Four characteristics of participation are addressed. In the first characteristics, students provide health services based on the clients' needs. The second one allows clients to participate in data collection, analyses and identification of solutions and allows clients to make their own decisions based on the appropriate and comprehensive information given. The next one, as a healthcare provider, students should pay a role in supporting, motivation, and providing solutions, but do not decide the medical intervention required for the clients. The last one, healthcare providers should promote competency in solving their own problem and build their strong self-reliance [2, 3].

Nursing is more than a learned science. It is the art a person uses to approach other people and establish a certain degree of relationship with them. In order to humanize, it is necessary for nursing students to adopt practices in which the biological, psychical, ethical, educational, social, spiritual and subjective aspects are integral parts of health care, benefiting both the client and the professional, as a tool for recovering and maintaining health [4]. In order to enhance humanized care behaviors among nursing students, nursing colleges under PIHWD included Boromarajonani College of Nursing, Nakhon Ratchasima, have implemented several activities conducted both inside and outside of the classroom, such as the ideas of volunteer for giving care the clients during their summer vacation to enhance nursing students to be service-minded individuals, employing a local wisdom, Korat song, for giving physical and mental health education to enhance humanized care in the community setting, and significantly, implementing moral camps, as a Buddhist, for enhancing humanized care

and increasing the strong relationship between caring and humanism. More importantly, Boromarajonani College of Nursing, Nakhon Ratchasima has been using authentic learning in order to enhance humanized care for many years. The authentic learning especially in clinical practices with real situations leads undergraduate nursing students to understand the relationship between caring individuals, understanding humanity, human right, and patients' right and providing human basic needs.

However, little empirical evidence from previous studies have showed the results of providing the humanized care model among nursing students under the PIHWD. The academic formation has an important role in training future professionals, it is essential that stimulate the development of sensitivity to know the reality of a client and also of the hospital, communication, listening to their complaints and find ways to facilitate their acceptance and understanding their health problems [5]. As nursing is a profession focused primary for the care. Therefore, during graduation the students especially the 3<sup>rd</sup> and the 4<sup>th</sup> year learn the concept of caring and when they develop their activities practice, they have the opportunity to put those concepts into practice, and thus students will be prepared for their professional life. Based on this scenario, it was important to make research about the levels of humanized care behaviors. In this aspect this study bring the problems as following : 1) how does the level of perception on humanized care among undergraduate nursing students of the 3<sup>rd</sup> and the 4<sup>th</sup> year who have been experienced in both hospital and community training field ?, and 2) how does the difference of their perception among those three domains on humanized care?

## **2. Research objective (s)**

The aims of this exploratory descriptive study were 1) to identify the levels of humanized care behaviors according to the perception of the 3<sup>rd</sup> and the 4<sup>th</sup> year of the undergraduate nursing students and 2) to test the differences among three domains of humanized care behaviors reported by those two nursing student groups.

## **3. Materials and methods**

### *Type of research*

This study deals a research files, of quantitative type, of non-experimental nature, exploratory descriptive and transversal conducted in Nakhon Ratchasima, Thailand.

### *Population*

The total population of this study consisted of 345 nursing students from the 3<sup>rd</sup> and the 4<sup>th</sup> year of the undergraduate nursing program.

### *Sample*

The total samples for this study consisted of 186 nursing students. Taro Yamane formulation was used to calculate this sample size. A simple random sampling with a proportional method was adopted to select those samples from each class. The 90 samples were selected from the 3<sup>rd</sup> year and 96 samples were selected from the 4<sup>th</sup> year who consented to participate in the study voluntarily.

### *Criteria of inclusion and exclusion of subjects*

Criteria of inclusion:

- The research subjects must be the 3<sup>rd</sup> and the 4<sup>th</sup> year undergraduate nursing student.
- The selected student must sign the Statement of Informed Consent.

#### Criteria of exclusion

- Not belong to the 3<sup>rd</sup> and the 4<sup>th</sup> year undergraduate nursing student.
- Students who perchance refuse to participate voluntarily or are absent during data collection.

#### *Instrument for data collection*

The four two-page, anonymous, self-administered questionnaire, “The Identities of Nursing Student Questionnaire” adopted from Kittiporn Nounsuwan (2015) was applied for collecting data [6]. It was composed of two parts. The first part contains 10 close-ended items is for requesting demographic information. The second part contains 75 close-ended items using a 5-point Likert scale is for identifying participants’ perception that contributed to humanized care behaviors under three categories: service minded category contains 28 items, analytical thinking category contains 16 items, and participation category contains 31 items. Each item is rated so that “minimal practice” is 1 point and “maximal practice” is 5 points. The interpretation of score is ranked into 5 levels (10.00-1.50 = lowest, 1.51-2.50 = low, 2.51-3.50 = moderate, 3.51-4.50 = high, and 4.51-5.00 = highest). A higher score indicates a higher level of the perception toward humanized care.

#### *Validity and reliability of the study*

The content validity of this questionnaire was approved by three experts. It was pre-tested on 30 undergraduate nursing students - 15 from each class level - who did not participate in the actual study. Cronbach’s alpha coefficient for reliability of this questionnaire was .96.

#### *Description of data collection*

After approval of the project at the Institutional Review Board (IRB) of Boromarajonani College of Nursing, Nakhon Ratchasima, data was collected by the researchers from October 11-23, 2017. All the 3<sup>rd</sup> and the the 4<sup>th</sup> year nursing students were individually contacted and invited to participate in the study. The sample recruitment timeline was scheduled. If some refused to be part of the study, the next participants would be randomly selected and invited to participant before the end of recruitment timeline. On the day of administration of the questionnaire, participants were requested to gather in the college hall. To reduce the non - respondent rate, the information was not disclosed until all participants had gathered in the hall. All participants were then informed about the study objectives and the time required for participation before seeking their written consent to take part. To protect confidentiality and anonymity, participants were not asked to identify themselves and were not required to write their names on the questionnaire. In addition, participants were informed that findings would be presented as group data with no personal respondent information being reported. They were also informed that finding would not affect their academic grades and school performances. Participants were also instructed the correct way of completing the questionnaire and the anticipated interest in participating in this research. The exercise took about 50-55 minutes to complete and they handed them back to the researcher immediately upon completion.

## **4. Results and discussion**

### *Sample characteristics*

The 186 participants (100% responding rate) completed the questionnaires. The socio-demographic characteristics of the respondents are illustrated in Table 1

**Table 1** Socio-demographic characteristics of participants (N = 186)

Characteristics	3 <sup>rd</sup> year		4 <sup>th</sup> year		Total	
	n	%	n	%	n	%
Gender						
Male	3	3.3	8	8.3	11	5.9
Female	87	96.7	88	91.7	175	94.1
Age						
20	28	31.1	17	17.7	45	24.4
21	58	64.4	70	72.9	128	68.6
22	3	3.3	7	7.3	10	5.3
24	0	0	2	2.1	2	1.1
25	25	1.1	0	0	1	0.6

The prevalence of females in nursing profession is shared by few male, reflecting this historical characteristic of nursing where the profession of care is exercised exclusively by women due to the fact that the assignment of the great women have provided care for the education of children, housework and also conciliation with their work. It was found two age groups among participants, with the highest prevalence of students between 20 (24.4%) and 21(68.6%), a result that demonstrates the presence to young people entering the fact that the nursing program may be related to job offers and offer possibilities to enter quickly into the labor market.

Based on the objectives of this study, the results revealed that the overall scores of humanized care behaviors of participants from the 3<sup>rd</sup> ( $\bar{x} = 4.11$ ,  $SD = 0.39$ ) and the 4<sup>th</sup> year ( $\bar{x} = 4.12$ ,  $SD = 0.32$ ) were at high level. There was no statistically significant difference between those two overall scores. The highest average scores of each domains (service mind, participation, and analytical thinking) for those two groups of participants were at high level. There were no statistically significant differences in service mind and analytical domains between those two groups of participants. However, those two groups of participants identified the difference on participation domain at a statistically significant level of .05. The details are illustrated in Table 2. By means of the answers given by the participants, it was clear that they are aware of the importance that humanization of health care can bring to clients, their families members, the team and the institution as a whole.

**Table 2** Mean, standard deviation, and independent sample t -test for testing the differences among three domains of humanized care behaviors between the 3<sup>rd</sup> and the 4<sup>th</sup> year participants

Variable / Group	3 <sup>rd</sup> year	4 <sup>th</sup> year	t -test	df	p (2-tailed)	$P^* <$
	$\bar{x}$ (SD)	$\bar{x}$ (SD)				
Service mind	4.31(0.36)	4.37(.33)	-1.24	184	.22	
Analytical thinking	3.91(0.42)	3.94(0.38)	-.53	184	.60	
Participation	4.12(0.50)	4.25(0.37)	-2.17	162.73	.03*	
Overall	4.11(0.39)	4.12(0.32)	-1.47	172.48	.14	

The study results suggested that participants from the 3<sup>rd</sup> and the 4<sup>th</sup> year of the undergraduate nursing program studying at Boromarajonani College of Nursing, Nakhon Ratchasima, under the PIHWD considered the importance of humanized care behavior at the same level although they are studying in the different academic

level. We expected that the 4<sup>th</sup> year undergraduate nursing students would express their perception on humanized care behaviors stronger than the other one. Considering the reasons to support this results, the syllabus subjects studied in the third year of the undergraduate nursing course would be the best evidence to support this finding. Many subjects both in theoretical and practical parts such as intensive nursing care, terminal illness nursing care, oncology nursing care, and psychiatry nursing care are best covered the theme of humanized care while many subjects studied in the fourth year are more focused in details of nursing profession and the advances of medical technology for healing the patients than other academic levels. In the undergraduate nursing course, much is taught on science and technology. However, the theme of humanized care should be and can be incorporated during all levels of education process of nursing profession. Within all this learning, the subjects with humanistic approached should also be an integral part of the curriculum, since the students are concerned with tasked related to cure, prevention, and rehabilitation of the client, as well as human nature and social well-being [4].

It is important to note that the actions intended to humanize health care need to be implemented and followed, not only as a rules, but as a chance of culture, from teaching institutions to hospital institutions. Only a humanized team can humanize health care. As professionals and human beings that come from a common society, together with patients and their families, we need to build a healthier world in harmony with the rights of human beings [4]. The nursing student when is aware of this importance, learn more clearly the nuances of caring, and acquire importance features to cope with difficulties, specifically, the sensitivity to recognize the reality of the patient, listening to their complaints and find ways to facilitate their acceptance, communication and understanding of the health problems, becoming a mature professional and trained in humanized care.

## 5. Conclusions

The present study led us to conclude that

- Humanized care behaviors reported by the 3<sup>rd</sup> and the 4<sup>th</sup> year of the undergraduate nursing students studying at Boromarajonani College of Nursing, Nakhon Ratchasima, under the PIHWD were the same at high level.
- All three domains of humanized care behaviors (service mind, analytical thinking, and participation) for those two groups of the undergraduate nursing students need to be promoting into higher level before graduation especially the participation domain.
- The theme of humanized care behaviors should be and can be incorporated during all levels of education process of nursing profession.

## Acknowledgements

This study was funded by Boromarajonani College of Nursing, Nakhon Ratchasima, Thailand.

## References

- [1] Emilis CP, Ingrid AB, Maria Julia PS. Humanized care: the act with respect to design improving student nursing. *Acta Paul Enferm.* 2011; 24(3):334-40.
- [2] Praboromarajchanok Institute for Health Workforce Development. *Manual on the Implementation on Humanized Care.* Bangkok: Yutharin Pub. 2013.
- [3] Phepun P, Wareewan S. The opinions of nursing students regarding humanized care through volunteer

activities at Boromarajonani Collega of Nursing, Chonburi. *International Scholarly and Scientific Research & Innovation*. 2016; 10(6):2007-2010.

- [4] Dyane R, Rachel DC. Humanizing health care: what do nursing students think? *Einstein*. 2007; 5(4); 315-320.
- [5] Jaqueline GO, Aurea AV. Hospital nursing and humanization: knowledge of undergraduate nursing students. *J Health Sci Inst*. 2013; 31(3): 36-42.
- [6] Kittiporn N, Sermsak W, Wittawat DS. Strategies to Develop the Nursing Students' Identity in Nursing Colleges, Ministry of Public Health. *Hatyai Journal*. 2015; 13(2) Jul-Dec: 117-132.



## **Health literacy of Cambodian transnational workers in Nakhon Ratchasima province via social media online**

Dussadee Triyawong<sup>1,\*</sup>, Chatthong Jarupisitpaiboon<sup>1</sup>, Nattineeporn Chantaranothai<sup>1</sup>,  
Narumon Premmasawat<sup>1</sup>, Areerat Pesungnoen<sup>1</sup>

<sup>1</sup>Department of Community health nursing, Boromarajonani College of Nursing, Nakhon Ratchasima  
30000, Thailand

### **Abstract**

Recently, there was increasing a number of Cambodian workers in Thailand and also Nakhon Ratchasima province. This may affect health system and infectious control in Thailand. Therefore, health and self-care information are vital to improve health knowledge of the workers and their self-care ability. Social media online become important in society may assume that it is an effective channel to communicate or pass the message including health care message to the people this because everyone are able to access the way easily. This study aims to study health literacy in Cambodian worker in Nakhon Ratchasima province and behavioral of Cambodian workers for seeking health information to improve their self-care via social online media. This study is a descriptive study design. The data were collected by interview questionnaires. This study include 326 Cambodian workers in Nakhon Ratchasima province. The sample size were calculated by package program <http://www.nss.gov.au/nss/home.nsf/pages/Sample+size+calculator> with 95% confidence interval and relative error 2.0% plus 10% for loss then, 326 participants were collected. This study has been approved by Ethical committee of Bororajajonani College of nursing, Saraburi. The data were collected between January – November 2016. The return rate of questionnaire was 100 %. Descriptive statistics was used for data analysis. The results reveal that, the personal data most of them graduated from elementary school = 198 workers (60.7%). A half of them (54.3%) had health insurance for foreign workers while 32.2% self-support for their health. In term of self-care 81.3% of them was met doctor for their illness, 14.4% buy medicine from drug store and 4.3% went to private clinic. Most media used (36.2%) was Facebook, 23% was YouTube for entertainments and 17.8% was Line application respectively. Most search for seeking drug using for self-care (19.9%) and how to treat the disease (19.6%) for the searching purposes.

In conclusion, the study was reflex to health literacy of Cambodian worker in Thailand via social media used and also identified behavior on social media used for health and self-care data seeking. This may benefit to develop health program to improve their health behavior which aim to infection controlled in Thailand.

**Keywords:** health literacy, health in Cambodian worker in Thailand, online social media used for health

---

\*Corresponding author; triyawong\_dus@yahoo.co.th

## 1. Introduction

According to data of Foreign Workers Administration Office [1] there was increasing a number of transitional workers in Thailand. The statistic had presented in year 2015 the number of transitional legal workers was 1,513,094, most of them was 527,563 Cambodian workers (34.87%) (Department of Employment, [2]) and also in Nakhon Ratchasima province. In 2016, the data shown that legal transitional workers in Nakhon Ratchasima was 12,531, greatest number was Cambodian worker (9,821 workers), Myanmar was 1,527 and Laos was 1,183 respectively. While, the number of transitional worker was increased, conversely the number of worker who registers in National Health System was declined dramatically. This possible to indicated that there were a huge number of illegal workers in nation working system. This may affect health system and infectious control in Thailand, related to the study of Chaisuparakul [3] shown that Tuberculosis was an infectious disease was most found in Cambodian worker due to inappropriate working environment.

Due to a number of illegal transitional workers did not register in to Thailand National Health System this consequence not only epidemiological surveillance report loss but also delay of treatment and help for disease and all of this may cause of uncontrolled infectious disease to the group of transitional workers and Thai people. According to supporting data, improving of health literacy might help improving self-care behaviour. Furthermore, to increase ability of health literacy varieties skill is required. However, ability for social media used was different in difference people depend on their experience, educational and skill of searching. For that reason, improving social media using skill may improve health literacy and raise self-care ability then disease is controlled.

Health literacy has been defined as the cognitive and social skills which determine the motivation and ability of individuals to gain access to, understand and use information in ways which promote and maintain good health. Health Literacy means more than being able to read pamphlets and successfully make appointments. By improving people's access to health information and their capacity to use it effectively, health literacy is critical to empowerment (WHO[4]). Additionally, U.S. Department of Health and Human Services Office of Disease Prevention and Health Promotion [5] define Health literacy “ is the degree to which individuals have the capacity to obtain, process, and understand basic health information and services needed to make appropriate health decisions” this obtained individual and systemic factors of communication skills of lay persons and professionals, lay and professional knowledge of health topics, culture, demands of the healthcare and public health systems, demands of the situation/context. Moreover, numeracy skills also essential to health literacy for instance, measuring drugs, calculating blood sugar and lipid level in blood and understanding on nutrition label for comparing nutrient in food to choose the appropriate things to improve their health outcomes. Therefore, health and self-care information are vital to improve health knowledge of the workers and their self-care ability. Unavoidable to say that almost people had mobile phone and experience to use online media hence, social media online become important in society. All people is able to access information via social media including health information (Kutner et al [6]; Neter and Brainin [7]). This may assume that online media is an effective channel to communicate or pass the message including health care message to the people. Nowadays, health literacy is an importance ability of people for seeking information to decide to solve their health problem appropriately. In Cambodian transitional workers mobile phone was essential communication instrument for them to pass the message, access needed information and update information.

Survey of behaviour to seek health information and health literacy via social media in the transitional worker will develop useful information for administrative management planning to promote health promotion and improve self-care behaviour in transitional worker via communication technology effectively. This aims to reduce cost of health care service to transitional worker and control infectious disease.

## 2. Research objective(s)

This study aims to study health literacy in Cambodian worker in Nakhon Ratchasima province and behavioural of Cambodian workers for seeking health information to improve their self-care via social online media.

## 3. Materials and methods

This study is a descriptive study design. The data were collected by interview questionnaires. This study include 326 Cambodian workers in Nakhon Ratchasima province. The sample size were calculated by package program <http://www.nss.gov.au/nss/home.nsf/pages/Sample+size+calculator> with 95% confidence interval and relative error 2.0% plus 10% for loss then, 326 participants were collected. This study has been approved by Ethical committee of Bororajonani College of nursing, Saraburi. The data were collected between January – November 2016. The return rate of questionnaire was 100 %.

The data were collected by a questionnaire was considered by 3 experts and reliability was .98. There was 4 parts of questionnaire as following;

Part1 The 10 questions ask about personal information the questions ask general details of participant i.e. gender, age, educational level, occupation, married status, type of residence and income.

Part 2 The 10 questions related to personal health perception. The answer was a 1-10 linear score.

Part 3 There was 4 questions related to the behaviour and frequency of using online media/and digital social network.

Part 4 It was the part of health literacy. There were 3 main issues as following;

(1) Searching behaviour on online media and social media.

(2) Knowledge and understanding on information resource from online media

Skill for using social media

Descriptive statistics; frequency, percentage, average score and standard deviation was used for data analysis in terms of personal information, social media used behaviour.

## 4. Results

Demographic was illustrated, the sample size was 326 participants, the majority of participants was female (64.4%) and a half of them was male (35.6%). The average of age was 28 years old. The percentage of marital status shown over a half of them (58.3%) was single and 39.3% was married. Most of them graduated from elementary school = 198 workers (60.7%). A vast majority of them work in manufacturer was 91.4%. Average of income was 10,265.40 Baht per month. There were 97% of the group without Non Communicable Diseases (NCD).

**Table 1** The number and percentage of self-care behavioural when they got illness (n= 326)

Self-care behavioural	The number of participant	Percentage
Buy medicine from drug store	47	14.4
Visit doctor at private clinic	14	4.3
Meet doctor at public hospital	265	81.3

According to table 1, the data was shown the greatest of participant (81.3%) met the doctor in public hospital while 14.4% buy medicine from drug store and minimize of the group visit doctor at private clinic when they had illness. This because they was register in to Thailand National Health System and confidence in doctor in public hospital wear as, some of them decided to buy medicine from drug store because this way easier to treat themself for the reason. While, small of them prefer to met doctor in private clinic due to saving of time.

**Table 2** Frequency of using online media (n=326)

Type of online media	Frequency for using online media in a week				
	Never	1-2 days	3-4 days	5-6 days	Everyday
E-mail	292 (89.6%)	11 (3.4%)	1 (.3%)	2 (.6%)	20 (6.1%)
Line	207 (63.5%)	43(13.2%)	14 (4.3%)	4 (1.2%)	58 (17.8%)
Instagram	295 (90.5%)	8 (2.5%)	1 (.3%)	0 (0%)	22 (6.7%)
SocialCam	294 (89.6%)	7 (2.1%)	2 (.6%)	1 (.3%)	22 (6.7%)
Twitter	298 (91.4%)	4 (1.2%)	0 (0%)	1 (.3%)	23 (7.1%)
Facebook	113 (34.7%)	72 (22.1%)	20 (6.1%)	3 (.9%)	118 (36.2%)
Blogs	297(91.1%)	10 (3.1%)	0 (0%)	0 (0%)	19 (5.8%)
Thread in web board	296 (90.8%)	15 (4.6%)	0 (0%)	0 (0%)	15 (4.6%)
Search and download data	272 (83.4%)	17 (5.2%)	4 (1.2%)	2 (.6%)	31 (9.5%)
VDO clip and song online	183 (56.1%)	49 (15.0%)	17 (5.2%)	2 (.6%)	75 (23.0%)
Online games	282 (86.5%)	12 (3.7%)	2 (.6%)	3 (.9%)	27 (8.3%)

As can be seen from the data in table 2, most regularly using online media were Facebook, VDO clip in YouTube and Line respectively. In term of Facebook they most frequency use every day was 36.2%. Whereas Instagram was lowest using experience in the group of participant.

**Table 3** The number and percentage of participant was using electronic device to access online data (n=326)

Electronic device	Number of participant	Percentage of participant
Mobile phone	323	99.1
Computer/notebook	1	0.3
In working office	1	0.3
Internet Café	1	0.3

From the data in table 3 had presented vast majority of the group used mobile phone as an online media for accessing data online this because mobile phone was appropriate electronic device to carry on working site area.

**Table 4** Frequency of behavioural for searching online health data (n=326)

Health issue	The number and Percentage			
	Very often	Often	Sometimes	Never
Germ	5(1.5%)	12(3.7%)	48(14.7%)	261(80.1%)
Healthy life style	6(1.8%)	12(3.7%)	48(14.7%)	260(79.8%)
Medicine for illness	6(1.8%)	7(2.1%)	52(16.0%)	261(80.1%)
Treatment for illness	6(1.8%)	9(2.8%)	49(15.0%)	262(80.4%)
Health provider	5(1.5%)	8(2.5%)	46(14.1%)	267(81.9%)
Health organization	4(1.2%)	9(2.8%)	41(12.6%)	272(83.4%)
Laws and Rule related to health	3(.9%)	9(2.8%)	42(12.9%)	272(83.4%)
Health peer group	3(.9%)	9(2.8%)	45(13.8%)	269(82.5%)

As the data in table 4 was illustrated the trend of most searching on health issue was medicine for illness and sometimes frequency searching whereas searching for health organization, Law and rule related to health was the least issue search.

**Table 5** The level of health literacy via online media in Cambodian worker

Health literacy issue	Level of perception					Mean	SD.
	Highest	High	Medium	Less	Least		
I know resource of health information via internet	27(8.3%)	11(3.4%)	1.397	27(8.3%)	253(77.6%)	1.35	1.397
I know the searching resource of health	28(8.6%)	10(3.1%)	1.405	26(8.0%)	248(76.1%)	1.39	1.405
I know how to use the internet for searching information on my health problem	28(8.6%)	14(4.3%)	1.422	30(9.2%)	243(74.6%)	1.42	1.422
I know online media resource for health	27(8.3%)	13(4.0%)	1.401	24(7.4%)	250(76.7%)	1.39	1.401
I know how to use health information via online media to apply for self-care	33(10.1%)	11(3.4%)	1.464	30(9.2%)	243(74.6%)	1.44	1.464
I have evaluation skill on health information from the internet	27(8.3%)	11(3.4%)	1.391	31(9.5%)	246(75.9%)	1.38	1.391
I have ability to classified	28(8.6%)	11(3.4%)	1.400	27(8.3%)	249(76.4%)	1.39	1.400

Health literacy issue	Level of perception					Mean	SD.
	Highest	High	Medium	Less	Least		
quality of health information from online media							
I feel confidence for using health information from the internet to decide for my self-care	29(8.9%)	9(2.8%)	1.393	26(8.0%)	254(77.9%)	1.36	1.393
Total						1.39	0.41

As can be seen from the data in table 5 was illustrated SD. in total aspects was slightly different SD. = 0.41). Conversely, when consider in each aspect the data was indicated all of aspects were rather different.

**Table 6** The level of confident on online media (n=326)

Issue	Level of confident				
	Not at all confident	Not very confident	Somewhat confident	Very confident	Completely confident
In overall, How is your confident level on health information via online media	12 (3.7%)	7 (2.1%)	73 (22.4%)	121 (37.1%)	113 (34.7%)
In overall, How is your confident level in your self-care ability	5 (1.5%)	13 (4.0%)	45 (13.8%)	156 (47.9%)	107 (32.8%)

The results in table 6 had presented the trend of confidence level of participants on online health information most of them (37.1%) was very confidence and 113 participants (34.7%) was completely confidence and 73 of them (22.4%) somewhat confidence. This may assume that online media has influence to health believe and self-care confidence on transitional worker in Nakhon Ratchasima province. Furthermore, self-confidence on their self-care ability was very high score.

## 5. Discussion

The results reveal that, Cambodian workers in Nakhon Ratchasima province most use mobile phone as an electronic device for online communication this related to the study of Jantima [8] to compare online using for health literacy in Cambodian worker, and Nida poll [9] to study internet using behaviour in Thai people found that mobile phone was most using for online data access mostly communication purpose. Due to searching data behaviour on health the data shown small number of searching behaviour the Cambodian workers in Nakhon Ratchasima related to previous data the workers had average age group = 28 years old this may

assume that they was still healthy they may not need health information for their self-care whereas they regularly using for communication.

In terms of health literacy in Cambodian worker in Nakhon Ratchasima province was low level of health literacy by the data average score = 1.39 (SD. = 0.41). Furthermore, searching skill via internet was low also; the study was reflex to health literacy of Cambodian worker in Nakhon ratchasima via social media used and also identified behaviour on social media used for health and self-care data seeking, this may affect low of self-care behaviour of the worker in further.

### Acknowledgements

To the authors do appreciated to Boromarajonani collage of nursing, Nakhon Ratchasima for funding in this study. The also deeply grateful to all participants for their cooperating and the obtained results.

### References

- [1] Foreign Workers Administration Office. **Statistical of foreign worker**; 2016 [cited 10 January 2016]. Available from: <https://www.doe.go.th/prd/alien/statistic/param/site/152/cat/82/sub/0/pull/category/view/list-label>
- [2] Department of Employment. **Labour migration in Thailand**; 2015 [ cited 2016 December 10]. Available from [http://eeas.europa.eu/delegation/thailand/documents/thailande\\_eu\\_coop/migration\\_management/11\\_labour\\_migration\\_in\\_thailand\\_en.pdf](http://eeas.europa.eu/delegation/thailand/documents/thailande_eu_coop/migration_management/11_labour_migration_in_thailand_en.pdf)
- [3] Chaisuparakul S.. Life and community of Cambodian migrant workers in Thai society. **Journal of Population and Social Studies**, 2015; **23**(1),2-16
- [4] WHO. Background Note: Regional Preparatory Meeting on Promoting Health Literacy [Internet]. UN ECOSOC, 2009 [cited 2016 January 11]. Available from: <http://www.un.org/en/ecosoc/newfunct/pdf/chinameetinghealthliteracybackgroundpaperv2.pdf>
- [5] U.S. Department of Health and Human Services Office of Disease Prevention and Health Promotion. Health literacy basic; 2016 [cited 2016 January 11]. Available from: <https://health.gov/communication/literacy/quickguide/factsbasic.htm>
- [6] Kutner M, Greenberg E, Jin Y, Boyle B, Hsu YC, Dunleavy E. Literacy in everyday life: Results from the 2003 National Assessment of Adult Literacy. National for Education Statistics. **NCES 2007-490**.
- [7] Neter E, Brainin E. eHealth literacy: Extending the digital divide to the realm of health information. **Journal of Medical Internet research**, 2012; **14**(1): e19
- [8] Jantima K, Tassanee K, Siritorn Y, Panitnat C, Pornlert C. Online social media uses and eHealth literacy of Cambodian workers in Thailand. **TLA Research J Journal of the Thai Library association**. 2017; **10**(1): 33-46.
- [9] Nida poll. **Behavioural for internet using**; 2017 [ cited 2016 December 10]. Available from <http://nidapoll.nida.ac.th/index.php?op=polls-detail&id=318>

# The Effect of Empowerment Program on Self-Care Behaviour of Elderly People with Hypertension at Nakhon Ratchasima Province, Thailand

Kornkan Phuengnam<sup>1,\*</sup> and Watcharee Sangsai<sup>1</sup>

<sup>1</sup> Psychiatric Nursing Department, Boromarajonani College of nursing, Nakhon Ratchasima, Nakhon Ratchasima 30000, Thailand

## Abstract

Hypertension is a global public health issue and causes a major health-care burden. The high prevalence of Hypertension disease enables it to be one of the leading causes of morbidity and mortality worldwide, including Thailand. The purposes of this quasi-experimental pre-test – post-test with control group research design were to compare: 1) self-care behaviours of elderly persons with hypertension disease before and after received the empowerment program, and 2) self-care behaviours of elderly persons with hypertension disease who received the empowerment program and those who received standard nursing care for hypertension. The sample consisted of 32 persons with the hypertension disease, divided into a control group 16 persons, and an experimental group 16 persons. They were matched-pair by self-care behaviours score then randomly assigned to either the experimental or control group. Research instruments consisted of: 1) The Empowerment Program, 2) the self-care behaviours questionnaire. All instruments were validated for content validity by 3 professional experts. The reliability of the 2<sup>nd</sup> instruments were reported by Cronbach's Alpha coefficient as of .81. Data were analyzed using descriptive, dependent and independent t-test.

Findings were summarized as follows:

- 1) The persons who received the empowerment program with was significant higher than that of those who received regular nursing care ( $t = 2.63, p < .05$ );
- 2) The self-care Behaviours in experimental group after receiving the empowerment program was significant higher than that before ( $t = 7.31, p < .05$ ).

**Keywords:** Empowerment, Self-care Behaviours, Hypertension

## 1. Introduction

The interesting phenomena in the world is aging phenomenon. This phenomenon is one of the major demographic, social, economical, and medical issues [1]. Studies showed that the world population is currently aging. According to the United Nations' report in 2025 there were approximately 100 million people [2]. Similarly, In Thailand there were elderly persons about 3.3 millions and 11.6 millions in 2010 and 2040 respectively [3]. Therefore, self-care behaviors of elderly is important for health care system especially elderly who live with hypertension diseases. Hypertension is defined as a systolic blood pressure (SBP) of 140 mm Hg or more, or a diastolic blood pressure (DBP) of 90 mm Hg or more, or taking antihypertensive medication. In addition the Seventh Report of the Joint National Committee on Prevention, Detection, Evaluation, and Treatment of High Blood Pressure (JNC 7) recommends the classification of BP for adults aged 18 years or older has been as follows Normal: Systolic lower than 120 mm Hg, diastolic lower than 80 mm Hg, Prehypertension: Systolic 120-139 mm Hg, diastolic 80-89 mm Hg, Stage 1: Systolic 140-159 mm Hg, diastolic 90-99 mm Hg, Stage 2: Systolic 160 mm Hg or greater, diastolic 100 mm Hg or greater [4].

Hypertension is common worldwide and causes a major health-care burden. Moreover, It has been long recognized that hypertension is an important risk factor for cardiovascular disease and mortality (responsible for 13% of deaths globally). World Health Organization [5] report that High blood pressure is the majority of leading risk factor causes of death by income group in 2004, approximate number is 7.5 millions or 12.8 Percentage of total. Similarly in Thailand, hypertension causes higher the percentage of death about 3,684 persons and 5,165 persons in 2012 and 2013 respectively and this disease was identified as a majority reason for Disability-Adjusted Life Years-DALYs of elderly people in Thailand, male about 20 and female about 22% [6].

---

\* Corresponding author; e-mail: konkan@knc.ac.th



Management of hypertension is importance to control hypertension and decrease the chance of these consequences. According to the world health organization (WHO), one way to better control hypertension to involve patients in their own self-care surveillance [7]. On the other hand, inappropriate self-care behaviors of elderly persons in Thailand who live with hypertension is still has found. For example eat high sodium food, non exercise, lack of awareness and has non medication adherence. Moreover, report that low stress management, non adherence with treatment and not follow-up lead to the intensity of hypertension [5].

Empowerment is a positive concept of a power or authority given to do something and is also a dynamic thought that can be shared, taken or given to others. In nursing, empowerment can be defined as an interpersonal process between the nurse and the patient intended to facilitate self-care behaviors. According to Gibson [8], the factors influencing on individual empowerment consist of internal factors and external factors. Firstly, internal factors include the responsibilities on self-care, knowledge, self efficacy, self esteem in problem solving and life goals. Secondly, external factors include knowledge, spirit, confidence and life supporting from family members and health officials. So if a person lacks these factors, they will not have the power to face any further problems.

For this study, the intervention will be developed by the researcher based on the model of empowerment of Gibson [8] which focuses on ability of people. The empowerment processes consist of supporting a patient to set personally meaningful and power-oriented goals, encouraging patient's self-efficacy and self-esteem, teaching people skills and knowledge that will motivate them to take steps to improve their own lives, and providing opportunities and resources for people to gain experiences and skills while they also gain control over their lives. The program in this research is created for managing internal and external factors of self-care behaviors. The Empowerment program there are 4 stages. Include stage 1 perceiving the threat , stage 2 improve self-efficacy, stage 3 improve self-esteem and Stage 4 evaluation.

The expected result of the study is discovering the method to sustain good practice in self-care behaviors of elderly persons with Hypertension. As a result, of elderly persons who live with Hypertension could control their blood pressure, reduce the risk of exacerbation, increase quality of life, and reduce rate of hospital admission as well as decrease the economic burden of the country.

## 2. Objectives

- 1) self-care behaviors of elderly persons with hypertension disease before and after received the empowerment program.
- 2) self-care behaviors of elderly persons with hypertension disease who received the empowerment program and those who received regular nursing care.

## Hypothesis

- 1) self-care behaviors of elderly persons with hypertension disease after received the empowerment program higher than before received program , significant level is .05
- 2) self-care behaviors of elderly persons with hypertension disease who received the empowerment program higher than who received regular nursing care, significant level is .05

## 3. Methods

This research is quasi-experimental pretest – posttest with control group research design .The sample were selected by simple random sampling from 17 primary health care hospitals to 1 primary health care hospitals that there are 84 elderly persons who received diagnosis hypertension and then were selected by purposive sampling. Including criteria are elderly people who have age between 60 - 89 years , diagnosis hypertension and have ability to communicate with each other. The sample consisted of 32 persons with the hypertension disease, divided into a control group 16 persons who received who received standard nursing care for hypertension, and an experimental group 16 persons that received four weekly empowerment sessions. They were pair - matched by self-care behaviors score then randomly assigned to either the experimental or control group.

Research instruments consisted of: 1) The Empowerment program based on the model of empowerment of Gibson [8] there are 4 stages. Include

stage 1 Perceiving the threat : 1.1 Making relationship between group member and nurse who is leader in group therapy . Encouraging patient's self-Awareness about the threat of patient, their family, and social that will motivate them to take steps to improve their own lives 1.2 Teaching psycho-education about meaning of disease, sign and symptoms, cause and factors that lead to hypertension as well as 13 dimentions of self-care behaviors .

stage 2 Improve self-efficacy : Review and learn skill of solving problems in the past from member group such as the way to success for healthy behaviors, strength or weak point when face with the problems. After discussion of solving problems in the past, the next activity is brain storming to create good practice or make choices for improve their self- care behaviors and providing the elderly to experiment the good practice in real situation.

stage 3 Improve self-esteem : Exchange experience after the elderly to experiment the good practice in real situation then learn together about the result that the method providing opportunities and resources for people to gain experiences and skills.

Stage 4 evaluation : Evaluate process of empowerment for holding on knowledge, attitude, and skill to solve the problems and improve their self-care behaviour.

2) The self-care behaviors questionnaire that items based on the model of self-care behaviors of Orem [9], there are 68 items from 13 dimensions. Include

1.Good Environment, 2.Healty Food, 3.Elimination, 4.Exercise and sleep, 5.Relationship or Participation, 6.Safety life, 7.Leisure activity , 8.Stress management , 9.Perceive of Disease  
10.Medication Adherence, 11.Good Information and support, 12.Adherence with doctor, and 13.Change to good behaviour

All instruments were validated for content validity by 3 professional experts. The validity of the 2<sup>nd</sup> instruments were reported by Content Validity Index as .88 and the reliability of the 2<sup>nd</sup> instruments were reported by Cronbach's Alpha coefficient as of .81

**Table 1** the mean score of self-care behaviors of elderly persons with hypertension disease before and after received the empowerment program.

self-care behaviour items	Pre-test (n = 16)	Post- test (n = 16)
1. Good Environment	4.44	4.58
2. Healthy Food	4.08	4.50
3. Elimination	3.13	3.57
4. Exercise and sleep	2.52	2.43
5. Relationship or Participation	2.27	3.77
6. Safety life	3.48	3.77
7. Leisure activity	3.48	3.76
8. Stress management	2.12	2.80
9. Perceive of Disease	2.04	3.08
10. Medication Adherence	2.93	2.94
11. Good Information and support	1.63	2.47
12. Adherence with physician	3.97	4.51
13. Change to good behaviour	3.70	3.99
<b>mean</b>	<b>3.06</b>	<b>3.31</b>

#### 4. Results and discussion

Demographic variables illustrates the majority of age in elderly persons who live with hypertension disease is between 65 – 69 years. the percentage of gender over half is female (62.50%), duration of illness is 9.25 – 9.56 years. The percentage of status is married about 56.30 % and 56.30% in control group and experimental group respectively .Moreover, the majority of education that sample graduate is primary school about 87.50.

**Table 2** the mean score of self-care of elderly persons with hypertension disease are compared before and after received the empowerment program.

The score of self-care behaviour	N	$\bar{X}$	S.D.	level	df	t	Sig.(1-tailed)
Pre - test	16	3.06	.38	high	15	7.31	.000*
Post - test	16	3.31	.36	high			

**Table 3** the mean score of self-care behaviors of elderly persons with hypertension disease are compared with who received the empowerment program and those who received regular nursing care.

The score of self-care behaviour	N	$\bar{X}$	S.D.	level	df	t	Sig.(1-tailed)
<b>Pre-test</b>							
Experimental group	16	3.06	.38	high			
Control group	16	3.00	.35	moderate	30	-.29	.356
<b>Post – test</b>							
Experimental group	16	3.31	.30	high	30	2.63	.006*
Control group	16	3.13	.33	high			

\* p < .05

The figures illustrate 1) The self-care Behaviors in experimental group after receiving the empowerment program was significant higher than that before (t = 7.31, p < .05) in table 2 2) The persons who received the empowerment program with was significant higher than that of those who received regular nursing care (t = 2.63, p < .05) in table 3

#### Discussion

In this study, it design were to compare self-care behaviors of elderly persons with hypertension disease before and after received the empowerment program and self-care behaviors of elderly persons with hypertension disease who received the empowerment program and those who received regular nursing care. The results of this study showed that the there were a significant difference between the mean difference before intervention, in 1-week interval after intervention in self-care behaviors and the mean of self-care behaviors of the elderly people between the experimental and control groups 1 week after finished intervention. In fact, it indicated the impact of intervention of empowerment program on the improvement of self-care behaviors of elderly persons with hypertension disease. This was consistent with the results of Keshvari and *et al.* [10] study in 2013.They illustrate the empowerment model based on family-centered that there are 4 process include : perceived threat, self-efficacy, self-confidence, and evaluation has been effective in improving metabolic syndrome symptoms and prevalence, empowerment scores, self-management behaviors, and walking (all p < .05). Similarly, in this study that the empowerment program is consist of perceiving the threat process, improve

self-efficacy process, improve self-esteem process, and evaluation process has been effective in self-care behaviors. This study results also confirmed in a study entitled “the effects of blood pressure monitoring on hypertension results”. This study stated that home blood pressure monitoring and self-management of hypertension in individuals in 51–76 years old people have facilitated the achievement of controlled blood pressure and it can promote medication [11]. The obtained results of empowering ability of people by supporting a patient to set personally meaningful and power-oriented goals, encouraging patient’s self-efficacy and self-esteem, teaching people skills and knowledge and providing opportunities and resources for people to gain experiences and skills while they also gain control over their lives that the effective process for improving their own lives and managing internal and external factors of self-care behaviors [8]. In confirming some of the results of this study, Natnipa Juntragulchai [12] in a study entitled, “The Outcomes of Empowerment Program in Uncontrolled Hypertension Patients” recommended empowerment program can able hypertension patients to control their blood pressure in normal level better than patients who are not to received empowerment program.

## 5. Conclusions

The empowerment program based on empowerment process of Gibson [8] can improve self-care behaviour of elderly person who live with Hypertension because this program in this research is created for managing internal and external factors such as eating high sodium food, non exercise, lack of awareness, non medication adherence, low stress management, non adherence with treatment and not follow-up lead to the intensity of hypertension. Besides, this program can encourage elderly person who live with Hypertension disease to have power and bring about effective problem solving. Therefore the empowerment program should be applied with others chronic disease or others people who are disempowerment person.

## Acknowledgments

To the authors appreciate Boromarajonani collage of nursing, Nakhon Ratchasima for supporting and cooperating in conducting this study. The also acknowledge the elderly people for their sincere cooperation and the obtained results.

## References

- [1] Nanbakhsh F, Mohaddesi H, Amirai A, Haji SM, Broomand F, Bahadori F, et al. The Effect of Health Education on Elderly Women Life Quality. **Payavard**. 2011; **5**: 47–57.
- [2] Rejeh N, Heravi KM, Montazeri A, Foroughan M. Psychometric Properties of The Iranian Version of The Facts on Aging Quiz (FAQI). **Payesh**. 2012; **11**: 245–2513.
- [3] Office of the National Economics and Social Development Board, Thailand. **Population Projections for Thailand 2010 – 2040**. Bangkok: Office of the National Economics and Social Development Board. 2013.
- [4] Aram VC, George LB, Henry RB, William CC, Lee AG, Joseph LI, Daniel WJ, Barry JM, Suzanne O, Jackson TW, Edward JR, The Seventh Report of the Joint National Committee on Prevention, Detection, Evaluation, and Treatment of High Blood Pressure. **Hypertension**. 2003; **42**:1206-1252
- [5] World Health Organization. **A global brief on Hypertension Silent killer Global public health crisis [Internet]**. (cited 15 April 2016). Available from: [http://www.who.int/cardiovascular\\_diseases/publications/global\\_brief\\_hypertension/en/](http://www.who.int/cardiovascular_diseases/publications/global_brief_hypertension/en/).
- [6] Bureau of Non-communicable Disease, Department of Disease Control, Ministry of Public Health. **ANNUAL REPORT 2015 [Internet]**. (cited 15 April 2016). Available from: <http://www.thaincd.com/document/file/download/paper-manual/Annual-report-2015.pdf>
- [7] Sayed FZM, Reza C, Erfan S, Ahmad AE. Self-Care Behaviors and Related Factors in Hypertensive Patients. **Iran Red Crescent Med J**. 2016; **18**(6): e35805.
- [8] Gibson CH. The process of Empowerment in mothers of chronically ill children. **Journal of Advances Nursing**. 1995; **32** (8): 1201-1210.
- [9] Orem DE. **Nursing: Concepts and Practice**. 6<sup>th</sup> ed. St. Louis, MO: Mosby. 2001.
- [10] Keshvari M, Hedayati B, Moeini M, Alhani F. A survey on the effect of implementation of a family-centered empowerment model on blood pressure and empowerment dimensions in the elderly people with hypertension. **J Educ Health Promot**. 2015; **4**:1-10.
- [11] Abudagga A, Resnick HE, Alwan M. Impact of Blood pressure telemonitoring on hypertension outcomes: **Telemedicine and E-Health**. 2010; **16**(7): 830–8.
- [12] Natnipa Juntragulchai. **The Outcomes of Empowerment Program in Uncontrolled Hypertension Patients [Thesis]**. Bangkok : Cristian University of Thailand; 2016.

# Effects of teaching with KORAT song on knowledge and self-care behaviors in prevention of non-communicable diseases among adults

Kanyapat Niyomsat<sup>1,\*</sup>, Chatchai Daengdi<sup>1</sup>, Kornkanok Kabkhoontod<sup>1</sup>,  
KawinnaKaeophimai<sup>1</sup>, Jugkapan Wanpugdee<sup>1</sup>, Jutamas Saichan<sup>1</sup>, Supaporn Chobsa-ard<sup>1</sup>  
and Supawan Pongpanna<sup>1</sup>

<sup>1</sup>Boromarajonanee College of Nursing, Nakhon Ratchasima,  
Nakhon Ratchasima 30000, Thailand

## Abstract

Prevalence of Non-Communicable Disease (NCD) among adults has risen greatly worldwide and it is the leading cause of deaths. Also, NCD is a major health problem resulting in serious actions. Korat song can help change the knowledge and self-care behaviors of adults in Nakhonratchasima province for their good health and well-being. The purpose of the study was to examine the effectiveness of teaching with KORAT song on knowledge and self-care behaviors in prevention of non-communicable diseases among adults. The population in this study were people 20-60 years old either male or female without a history of NCD. Therefore the sample size for this study was 52 participants, 26 for each group. Randomized matching were: age and sex. The samples were divided into two groups. One served as the control group and the others served as an experimental group. The experimental group received knowledge through KORAT SONG while the control group received lecture training. Research instruments consisted of: research instrument and data collecting instrument, Research Instruments such as Education to Prevent Non-Communicable Diseases by Using KORAT Song and Video Korat song, named "music to prevent NCD" and Data Collecting Instrument such as The Demographic Data Questionnaire, The Self-Care Knowledge Scale (CVI .87) and Behavior to Prevent NCD Questionnaire (CVI .87). Data were analyzed using descriptive statistics and hypotheses were tested using Wilcoxon signed ranks test. The results of the study indicated that Effects of Education to Prevent Non-Communicable Diseases by Using KORAT SONG could prevention Non-Communicable Diseases illness both Knowledge and Self-Care Behaviors among Adults. Therefore, the findings could be used as a guideline for prevention illness in adult with Non-Communicable Diseases.

**Keywords:** prevention non-communicable diseases by using KORAT song, self-care behaviors, knowledge, adults

## 1. Introduction

Non-Communicable diseases, also know as chronic diseases, are not passed from person to person. They are of long duration and generally slow progression. The four main types of Non-Communicable diseases are Cardiovascular disease, Diabetes Mellitus, Cancer and Chronic Obstructive Pulmonary Disease. Non-Communicable diseases prevalent among adult have risen greatly worldwide [1]. This has led to the cause of more deaths. It's a major health problem that warrants serious actions. In Thailand, fifty years ago the National Health Foundation and Thailand Research Fund Found reports have show that the prevalence of NCD has increased by 30 to 80 % [2]. Nakhonratchasima Province in northeast Thailand is now facing the Problem of increasing numbers of adults who are ill by Non-Communicable diseases.

Ministry of Public Health has health policy to prevent NCD, In 2014 the policies are: "Sam Oo Suang So Nuang Fo" Sam Oo includes food exercise and emotions Suang So includes not smoking and not drinking Nuang Fo includes tooth care [2].

Nowadays, the service of nursing should consider the traditional and cultural origin of the local community. How do we get the best benefit from this? The knowledge can then be applied in health care treatment for ourselves so we can depend only upon ourselves.

Korat song is a folk art of Nakhonratchasima that has been passed down to generations for a long time. It is unique in song, dance and music. Korat song is melodious and amusing whenever it is heard. We decided to choose Korat song to support self-care by "Sam OO Suang So Nuang Fo" to prevent Non-Communicable Diseases. Because Korat song is a folk art of Korat, we can identify it by the use of Korat language in the song, which is still used for local communication by Korat people.

\* Corresponding author; e-mail: Kanyapat@knc.ac.th

Therefore, we think Korat song can help change the knowledge and self-care behaviors of adult people in Korat for their good health. This will affect their quality of life in the future.

## 2. Objectives

The purpose of the study was to examine the effectiveness of teaching with KORAT song on knowledge and self-care behaviors in prevention of non-communicable diseases among adults.

### Research Hypothesis

2.1 The average of the post-scores for knowledge in the experimental group would be significantly higher than the pre-scores. ( $p < 0.05$ )

2.2 The average of the post-scores for self-care behaviors in the experimental group would be significantly higher than the pre-scores. ( $p < 0.05$ )

2.3 The average of the post-scores for knowledge in the experimental group would be significantly higher than those in the control group. ( $p < 0.05$ )

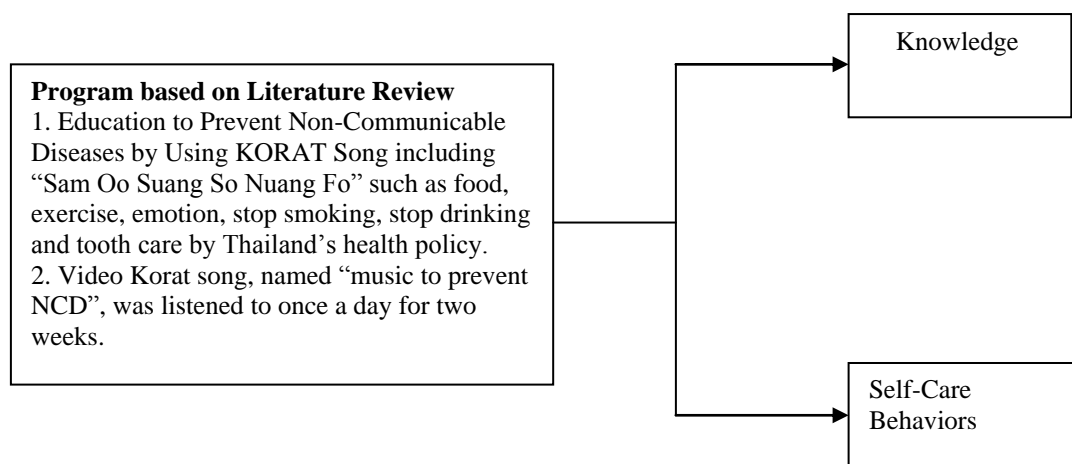
2.4 The average of the post-scores for self-care behaviors in the experimental group would be significantly higher than those in the control group. ( $p < 0.05$ )

### Conceptual Framework of the Study

Non-Communicable Diseases are prolonged. It may negatively affect the patient's holistic health and caregiver and the health care systems. The problem is influenced by lifestyles.

We develop strategies for the prevention of Non-Communicable Diseases by using Korat song including "Sam Oo Suang So Nuang Fo" such as food, exercise, emotion, stop smoking, stop drinking and tooth care by Thailand's health policy. The experimental group received the Education to Prevent NCD program by Using KORAT Song and Video Korat song, named "music to prevent NCD", The sample remained open to listen to once a day for two weeks.

Therefore, Korat song can change self-care behaviors and increase knowledge for adult people in Nakhonratchasima. This will reduce the risk of Non-Communicable Diseases in the future.



**Figure 1** Program based on literature review

## 3. Methods

This quasi-experimental study utilized a two- group pretest-posttest design to examine the effectiveness of teaching with KORAT song on knowledge and self-care behaviors in prevention of non-communicable diseases among adults. The study was conducted during mid-August to November 2016, at the Khamthaleso village and Khokfak village Khamthaleso district Khamthaleso prefecture Nakhonratchasima province.

### Population and Samples

#### Population

This study the population is people 20-60 years old either male or female without a history of NCD. The researcher stopped immediately to prevent selection bias. The inclusion criteria were:

- 1) Aged 20-60 years old
- 2) Without a history of NCD
- 3) Understand and speak KORAT language
- 4) Able to communicate verbally and
- 5) Willing to participate

#### Exclusion Criteria

- 1.) Had an NCD which would make them unable to participate in this research

## 2.) Unwilling to participate in this research process

### Samples

The appropriate sample size calculation was based on the power analysis of experimental research. The power of 80% , effect size .50, alpha .05 [3] and 22 subjects per group [4], the extra 4 participants of each group (20% of the total subject) were added to offset any missing subjects [5]. Therefore the sample size for this study was 52 participants, 26 for each group. Randomized matching were:age and sex

### Research Instruments

The Study had two instruments includes research instrument and data collecting instrument, all described below.

#### Research instrument

1) Education to Prevent Non-Communicable Diseases by Using KORAT Song, We decided to choose Korat song to support self-care by “Sam OO Suang So Nuang Fo” to prevent Non-Communicable Diseases. The content consisted of seven parts take about thirty minute.

2) Video Korat song, named “music to prevent NCD” was listened to once a day for two weeks.

Data Collecting Instrument included three parts. The first part was a Demographic Questionnaire which consisted of nine items asked the samples to provide information about sex, age, education level, occupation, income, family characteristics, annual health check, Source of annual health check etc. Second, the Self-Care Knowledge Scale consisted of six dimensions “Sam Oo Suang So Nuang Fo” such as food, exercise, emotion, stop smoking, stop drinking and tooth care with 15 items in three subscales. The results were interpreted such that higher score implied a higher level of self-care knowledge, which causes positive . On the other hand, low scores indicated a lower level of self-care knowledge. Third, the Self-Care Behavior to Prevent NCD Questionnaire consisted of 15 items. The scale used a 5 point rating scale rated as follows : 0=never ,1=seldom,2=sometimes,3=often, and 4=always .The overall scoring and interpretation of three level of self-care behavior to prevent NCD. The results were interpreted such that higher score implied a higher level of self-care behavior to prevent NCD, which causes positive . On the other hand, low scores indicated a lower level of self-care behavior to prevent NCD.The reliability of Self-Care Knowledge Scale and Self-Care Behavior to Prevent NCD Questionnaire were .87.

### Data analysis

The data was analysed by package program of SPSS/PC for windows.

1) Descriptive statistics were interpreted in frequency distribution, percentage, mean ( $\bar{x}$ ),and standard deviation (SD) used to analyze the participants’ demographic characteristics.

2) To compare difference average score of the pre- scores and post -scores for knowledge in the experimental group. Due to non-normal distribution of the data sets, used by Wilcoxon signed ranks test

3) To compare difference average score of the pre- scores and post -scores for self-care behavior in the experimental group. Due to normal distribution of the data sets, used by Dependent t-test

4) To compare difference average score of the Knowledge between the control and experimental groups. Due to non-normal distribution of the data sets, used by The Mann-Whitney U test

5) To compare difference average score of the self-care behavior between the control and experimental groups. Independent t-test was used by both groups was under independent condition with one-tailed test by statistic significant level at .05.

## 4. Results and discussion

### Results

According to data analysis a comparison of knowledge and self-care behaviors in the control and experimental groups, had presented as following

#### Part 1 Demographic data

This study the sample are people 20-60 years old either male or female without a history of NCD understand and speak KORAT language at the Khamthaleso village and Khokfak village Khamthaleso district Khamthaleso prefecture Nakhonratchasima province.

Therefore the sample size was 52 participants, 26 for each group, comparison of various aspects of the sample between the experimental group and the control group. At baseline, there were no significant differences between two groups with regard to sex, age and education level as presented in Table.

**Table 1** Demographic characteristics of participants (n = 52)

Demographic characteristics	experimental group (n = 26)		control group (n = 26)	
	n	%	n	%
<b>Sex</b>				
Male	10	38.46	10	38.46
Female	16	61.54	16	61.54
Age (experimental group $\bar{x}$ =44.88, S.D.= 11.63, range= 59-21; control group $\bar{x}$ =44.46, S.D.= 10.75, range= 59-23)				
21-30	5	19.23	5	19.23
31-45	5	19.23	5	19.23
46-60	16	61.54	16	61.54
<b>Education</b>				
Uneducated	1	3.85	0	0
Elementary School	12	46.15	12	46.15
High School	7	26.92	8	30.77
High Vocational Certificate	3	11.54	1	3.85
Bachelor degree	3	11.54	3	11.54
Master degree	0	0	2	7.69
<b>Family characteristics</b>				
Single family	14	53.85	15	57.70
Extended family	12	46.15	11	42.30
<b>Annual health check</b>				
never	4	15.38	9	34.62
ever	22	84.62	17	65.38
<b>Number of times</b>				
1 time/year	20	76.92	14	53.85
2 time/year	1	3.85	0	0
4 time/year	1	3.85	3	11.54
<b>Source of annual health check</b>				
Private hospitals	0	0	0	0
Public hospital	18	50	18	42.30
Health Promoting Hospital	5	19.23	8	30.77
Factory/Company	3	11.54	0	0
Weight (experimental group $\bar{x}$ = 67.81, S.D.= 17.77, range= 120-45; control group $\bar{x}$ = 66.88, S.D.= 13.39, range= 95-44)				



Demographic characteristics	experimental group (n = 26)		control group (n = 26)	
	n	%	n	%
≤ 40 kg.	0	0	0	0
41-60 kg.	11	42.31	0	0
61-80 kg.	9	34.62	9	34.62
81-100 kg.	5	19.23	13	50
≥ 101 kg.	1	3.85	4	15.38
Height (experimental group $\bar{x}$ =162.92, S.D.= 10.79, range= 193-145; control group $\bar{x}$ =144.46, S.D.= 10.75, range= 59-23)				
≤ 140 cm.	0	0	0	0
141-150 cm.	4	15.38	10	38.46
151-160 cm.	8	30.78	5	19.23
161-170 cm.	10	38.46	5	19.23
≥ 171 cm.	4	15.38	6	23.08
Waist circumference (experimental group $\bar{x}$ =84.04, S.D.= 10.99, range= 109-67; control group $\bar{x}$ =74.46, S.D.= 10.75, range= 59-23)				
≤70 cm.	3	11.54	0	0
71-80 cm.	6	23.08	7	26.92
81-90 cm.	10	38.46	10	38.46
91-100 cm.	5	19.23	6	23.08
101-110 cm.	2	7.69	2	7.69
111-120 cm.	0	0	1	3.85
≥121 cm.	0	0	0	0
Body Mass Index (experimental group $\bar{x}$ = 25.55, S.D.= 5.19, range= 40.09-17.99; control group $\bar{x}$ =24.46, S.D.= 10.75, range= 59-23)				
< 18.5 kg/(m) <sup>2</sup>	1	3.85	1	3.85
18.5-24.9 kg/(m) <sup>2</sup>	15	57.69	10	38.46
25-29.9 kg/(m) <sup>2</sup>	4	15.38	9	34.62
30-34.9 kg/(m) <sup>2</sup>	4	15.38	4	15.38
35-39.9 kg/(m) <sup>2</sup>	1	3.85	2	7.69
> 40 kg/(m) <sup>2</sup>	1	3.85	0	0

## Part 2

**Table 2:** Comparison of the knowledge score between pre-scores and post-scores in the experimental group.

Sample	The average of the post-scores for knowledge				z	p-value
	Pre-test		Post-test			
	$\bar{x}$	S.D.	$\bar{x}$	S.D.		
experimental group	11.35	1.94	12.96	1.78	-2.875	.002*

\*alpha (p &lt;0.05)

**Table 3:** Comparison of the self-care behaviors score between pre-scores and post-scores in the experimental group.

Sample	The average of the post-scores for self-care behaviors				t	p-value
	Pre-test		Post-test			
	$\bar{x}$	S.D.	$\bar{x}$	S.D.		
experimental group	39.77	5.41	44.31	5.07	-2.975	.006*

\*alpha (p &lt;0.05)

**Table 4:** Comparison of the knowledge score between the control and the experimental group.

Sample	The average of the post-scores for knowledge				z	p-value
	min	Max	$\bar{x}$	S.D.		
Experimental group	8	15	12.96	1.78	-2.244	.025*
Control group	6	14	11.38	2.84		

\*alpha (p &lt;0.05)

**Table 5:** Comparison of the self-care behaviors score between the control and the experimental group.

Sample	The average of the post-scores for self-care behaviors				z	p-value
	min	max	$\bar{x}$	S.D.		
Experimental group	33	54	44.31	5.07	2.895	.006*
Control group	23	59	38.58	8.73		

\*alpha (p &lt;0.05)

**Discussion**

The study found that average of the post-scores for knowledge in the experimental group ( $\bar{x}$ =12.96, SD=1.78) would be significantly higher than the pre-scores ( $\bar{x}$ =11.35, SD=1.94) (p<0.002). An average of the post-scores for knowledge in the experimental group ( $\bar{x}$ =12.96, SD=1.78) would be significantly higher than those in the control group ( $\bar{x}$ =11.38, SD=2.84) (p<0.025). The reason the program could significantly increase the knowledge may be due to the fact that the samples live in Khamthaleso district Khamthaleso prefecture Nakhonratchasima province, understand and speak KORAT language in daily life. Also, the program should be appropriate the traditional and cultural origin of the local community. Teaching with KORAT song to prevention of non-communicable diseases program including “Sam Oo Suang So Nuang Fo” such as food,

exercise, emotion, stop smoking, stop drinking and tooth care by Thailand's health policy (2014) [2]. The experimental group received the education from specialist at the first time and video KORAT song; remained open to listen to once a day for two weeks. Therefore, the samples understand, listened to it over and over again and memory. Korat song can change increase knowledge for adult people in Nakhonratchasima. The previous study by Prasertthaicharoen and Supgranon (2004) reports the same finding. The study was to compare knowledge in sixty diabetic older adult patients'. The experimental group received knowledge through MOH LUM folk song while the control group received lacture training. The results of study showed that the post-test score of knowledge about health care in the experimental group during the seventh day and two weeks after listening were better than before using MOH LUM folk song at a 0.05 level of significance. Knowledge scores in the experimental group collected during the seventh day and two weeks later were significant showing 0.05 differences in the control group [6]. Reports the same finding by Suwanwaiphatthana and Tuicharoen (2015) the study was to Examine the effectiveness of the dietary education through Korat Song for thai type II twenty –four diabetic patients. Therefore, the findings imply that dietary education through Korat Song can be used as a guide to enhance knowledge in diabetic patients at a 0.05 level of significance [7].

The study found that average of the post-scores for self-care behaviors in the experimental group ( $\bar{x}=44.31$ ,  $SD=5.07$ ) would be significantly higher than the pre-scores ( $\bar{x}=39.77$ ,  $SD=5.41$ ) ( $p<0.006$ ). An average of the post-scores for self-care behaviors in the experimental group ( $\bar{x}=44.31$ ,  $SD=5.07$ ) would be significantly higher than those in the control group ( $\bar{x}=39.77$ ,  $SD=5.41$ ) ( $p<0.006$ ). The previous study by Prasertthaicharoen and Supgranon(2004) was to compare practice in sixty diabetic older adult patients'. The experimental group received knowledge through MOH LUM folk song while the control group received lacture training. The results of study showed that the post-test score of practice in the experimental group during the seventh day and two weeks after listening were better than before using MOH LUM folk song at a 0.05 level of significance. Practice scores in the experimental group collected during the seventh day and two weeks later were significant showing 0.05 differences in the control group [6].

## 5. Conclusions

In summary, the experimental group had statistically significant improvement in Knowledge and Self-Care Behavior compared with control group between the first day and two weeks after baseline data was controlled.

## Recommendations

The findings indicated that the education to prevent Non-Communicable Diseases by using KORAT Song is a beneficial program in their practice to promote health for prevention NCD in adults. However, Future studies are required including.

- 1) Further studies use Education to Prevent Non-Communicable Diseases by Using KORAT Song program in others settings with different contexts, such as hospital or clinic.
- 2) Further studies needing a longer period of study are suggested.
- 3) There should be a study comparing the use of KORAT Song and others media such as Fawn Mor Lum Klorn, *Fawn Jerng* or Manora etc. as an alternative for adults for self-care and exercise.

## Acknowledgements

The authors gratefully acknowledge the Korat song President and Boromarajonanee College of Nursing, Nakhon Ratchasima for providing a grant to support the program implementation of this study. In addition, app participants are acknowledge and thanked for their significant roles in this study.

## Reference

- [1] WHO. "NCD mortality and morbidity". Web. Seb. 2014 [cite 30 October 2016]. Available from: [http://www.who.int/gho/ncd/mortality\\_morbidity/en/](http://www.who.int/gho/ncd/mortality_morbidity/en/).
- [2] Ministry of Public Health. "Sam OoSuang So NuangFo" ; 2014 [cite 20 October 2016]. Available from: <http://www.thaihealth.or.th>.
- [3] Cohen, J. A power primer. *Psychological bulletin*. 1992; 112(1), 155.
- [4] Burns, N., & Grove, S.K. *The Practice of nursing research: Conduct, critique, and utilization*. 6<sup>th</sup> ed. United States of America : Elsevier Saunders; 2009.
- [5] Polit, D.F. *Statistic and analysis for nursing research*. 2<sup>nd</sup> ed. United States of America: Pearson Education; 2010.
- [6] Prasertthaicharoen ,A. & Supgranon, R. The effects of using MOH LUM folk songs for providing health education. *Journal of Faculty of Nursing Burapha University*. 2004;12(2),43-54.
- [7] Suwanwaiphatthana, W. & Tuicharoen, J. The Effect of the dietary education through Korat Song for thai type II diabetic patients. *Boromarajonanee College of Nursing, Nakhon Ratchasima*; 2015.

# **Session of Humanities and Social Sciences**

# The Impact of Perceived Transformational Leadership on Perceived Employee Creativity in Orchid Farming in Nakhon Pathom Province

Panyindee Janjirapon<sup>1,\*</sup>, Hirannapat Minmantra<sup>1</sup>, and Thong-oon Woraya<sup>1</sup>

<sup>1</sup>Faculty of Management Science, Nakhon Pathom Rajabhat University

## Abstract

The objective of this research was 1) to study perceived transformational leadership level, 2) to study perceived employee creativity level, and 3) to study the impact of perceived transformational leadership on perceived employee creativity in orchid farming in Nakhon Pathom province. The sample were 249 entrepreneurs in orchid farming. The Questionnaire was used as the tool for data collection. The data was analyzed in term of frequency, percentage, means, standard deviation, Pearson Correlation Coefficient, and Regression Analysis. The results from this research indicated as follows: the mean score of perceived transformational leadership was at 3.98 (S.D. = 0.39). The mean score of employee creativity was at 3.95 (S.D. = 0.41). In addition, perceived transformational leadership positively affected to perceived employee creativity in orchid farming in Nakhon Pathom province ( $p < .01$ ).

**Keywords:** perceived transformational leadership, perceived employee creativity, entrepreneur

## 1. Introduction

Production factors which include land, labor, capital and entrepreneurship are not only factors to drive economic growth at present. As a result of the digital economy, information is rapidly spreading so creativity or innovation is essential. Creative product and service will add economic value or emotional value. Knowledge is not enough to develop this economy. Therefore, leadership and creativity will enhance the creative economy [1].

Leadership is an essential role in encouraging creativity, and performance of employees. Transformational leadership support employee creativity in dynamic environment [2]. There are many studies in the perceived transformational leadership and perceived creativity (e.g., [3];[4];[5];[6];[7]). Few studies are investigated in orchid farming context. Therefore, we investigate the impact of perceived transformational leadership on perceived employee creativity in orchid farming in Nakhon Pathom province.

## 2. Objectives

1. To study perceived transformational leadership level.
2. To study perceived employee creativity level.
3. To study the impact of perceived transformational leadership on perceived employee creativity in orchid farming in Nakhon Pathom province.

## 3. Review literature

Perceived transformational leadership refers to the perception of leader characteristics that develop full potential followers, meet the needs of followers, have ethics, and motivation. The developmental motivation helps followers to concentrate on the benefits of the organization over their own interests. Perceived transformational leadership consists of four components including idealized influence, inspirational motivation, intellectual stimulation, and individualized consideration [4];[5].

Perceived employee creativity refers to the perception of followers abilities that think new ideas, innovation creation, and problem solving. Three components of perceived employee creativity include thinking ability, creating Innovation and problem solving [5];[8];[9];[10].

Perceived transformational leadership has a positive effect on perceived employee creativity [2];[3];[4];[5];[6];[7].

---

\* Corresponding author; e-mail: janjirapon@webmail.npru.ac.th

#### 4. Methods

##### The population and sample

The population were 653 entrepreneurs in orchid farming in 2015 [11].

The sample were 249 entrepreneurs in orchid farming by using Yamane formula [12].

##### Research tool

The questionnaire was used as the tool for data collection. It was self-rating. Perceived transformational leadership was adapted from [4];[5], using a 5-point Likert scale (1=strongly disagree, 5=strongly agree). There were four factors including twenty one items. [4] and [5] indicated that Cronbach Alpha scores were between 0.70-0.87. Perceived employee creativity was adapted from [8];[9], using a 5-point Likert scale (1=strongly disagree, 5=strongly agree). There were three factors including eleven items. [8] reported that Cronbach Alpha scores were 0.79 and [9] showed that Composite Reliability was 0.88.

Three experts evaluated the questionnaire for content validity. Item of objective congruence index were more than 0.5. For reliability test, Cronbach alpha scores were calculated from t30 respondents and the scores were more than 0.70 [13]. In addition, Item-total correlation were more than 0.4 [14] from discrimination power analysis and factor loading were more than 0.4 [15]. Discrimination power and reliability test are shown in Table 1.

##### Data analysis

The data was analyzed in terms of frequency, percentage, means, standard deviation, Pearson Correlation Coefficient, and Regression Analysis.

**Table 1** Discrimination power and reliability test

Variable	Corrected item-total correlation	Cronbach alpha scores	Factor loadings
Perceived transformational leadership	0.453-0.909	0.95	0.439- 0.693
Perceived employee creativity	0.481-0.657	0.87	0.544- 0.706

#### 5. Results

The results are presented in three parts as followings: demographic characteristics, descriptive statistics of the variables and regression analysis.

##### Demographic characteristics

The majority of respondents in the research, 125 (50.20%) were female, 118 (47.40%) were between the ages of 30-39 years, and 160 (64.30%) were lower than bachelor degree. 83 (33.30%) of respondents had income per month between 15,000 – 20,000 Baht and 102 (41%) of respondents had business experience between 5 – 10 years. Demographic characteristics are shown in Table 2.

**Table 2** Demographic characteristics

Descriptions	Frequency	Percentage
<b>Gender</b>		
Female	125	50.20
Male	124	49.80
<b>Age</b>		
20-29 years	33	13.30
30-39 years	118	47.40
40 years and over	98	39.40
<b>Education Level</b>		
Lower than bachelor degree	160	64.30
Bachelor degree	71	28.50
Upper than bachelor degree	18	7.20
<b>Income per month</b>		
Less than 15,000 Baht	56	22.50
15,000 – 20,000 Baht	83	33.30
20,001 – 25,000 Baht	73	29.30
More than 25,000 Baht	37	14.90

**Table 2** Demographic characteristics (continued)

<b>Business Experience</b>		
Less than 5 years	49	19.70
5 – 10 years	102	41.00
11-15 years	88	35.30
More than 15 years	10	4.00

**Descriptive statistics of the variables**

The mean score of perceived transformational leadership was at 3.98 (S.D.=0.39). The highest mean score of perceived transformational leadership components was intellectual stimulation (Mean=4.00, S.D.=0.48). The mean score of perceived employee creativity was at 3.95 (S.D.=0.41). Thinking ability was the highest mean score of The mean score of perceived employee creativity (Mean=3.97, S.D.=0.43). Descriptive statistics of the variables are shown in Table 3.

**Table 3** Descriptive statistics of the variables

<b>Variables</b>	<b>Mean</b>	<b>S.D.</b>
<b>Perceived transformational leadership</b>	<b>3.98</b>	<b>0.39</b>
Idealized influence	3.94	0.51
Inspirational motivation	3.99	0.42
Intellectual stimulation	4.00	0.48
Individualized consideration	3.97	0.44
<b>Perceived employee creativity</b>	<b>3.95</b>	<b>0.41</b>
Thinking ability	3.97	0.43
Creating innovation	3.93	0.53
Problem solving	3.95	0.45

Correlation between perceived transformational leadership and perceived employee creativity

Perceived transformational leadership was positively related to perceived employee creativity ( $r = .585$ ,  $p < .01$ ) (Table 4).

**Table 4** Correlation between perceived transformational leadership and perceived employee creativity

<b>Variables</b>	<b>Perceived transformational leadership</b>
Perceived transformational leadership	1
Perceived employee creativity	0.585**

\*\*p-value<0.01

Regression analysis

Perceived transformational leadership explained 36.2% of the variance in perceived employee creativity (Table 5).

**Table 5** Regression analysis

<b>Variable</b>	<b>B</b>	<b>SE</b>	<b>Beta (<math>\beta</math>)</b>	<b>t</b>	<b>Sig</b>
Constant	-0.001	0.051		-0.012	0.991
Perceived transformational leadership	0.603	0.051	0.602	11.819**	0.000
R <sup>2</sup>	0.362				
Adjust R <sup>2</sup>	0.360				

\*\* p<0.01

**6. Discussion**

In this research, the mean score of perceived transformational leadership was at 3.98 which was in line with the previous research [4];[7]. The mean score of perceived employee creativity was at 3.95 which was in line with the previous research [7];[9]. In addition, perceived transformational leadership positively affected to perceived employee creativity in orchid farming in Nakhon Pathom province. The previous studies confirmed that perceived transformational leadership had a positive effect on perceived employee creativity [2]; [3];[4];[5];[6];[7].

## 7. Conclusions

The results from this research indicated that the mean score of perceived transformational leadership was at 3.98 (S.D.=0.39). The mean score of employee creativity was at 3.95 (S.D.=0.41). In addition, perceived transformational leadership positively affected to perceived employee creativity in orchid farming in Nakhon Pathom province. Therefore, entrepreneurs should develop transformational leadership for increasing employee creativity. Entrepreneurs should focus on individualized consideration such as recognition about the differences in employee and fairness. For intellectual stimulation, entrepreneurs should support employee to think new things. Moreover, entrepreneurs should be idealized influence by being a role model. Entrepreneurs should be inspire followers such as communication, challenge, and reward.

## References

- [1] Patluang, K. A Holistic Policy for Stimulating Creative Economy. *NIDA Development Journal*. 2011;51 (3): 207-230.
- [2] Teymournejad, K., & Elghaei, R. Effect of Transformational Leadership on the Creativity of Employees: An Empirical Investigation. *Engineering, Technology & Applied Science Research*. 2016; 7 (1): 1413-1419.
- [3] Sharma, P., Nagar, P., & Pathak, S. C.). Impact of Transformational Leadership on Creative Flexibility of Engineers in India. *Procedia-Social and Behavioral Sciences*. 2012; 57: 555-559.
- [4] Çekmecelioğlu, H. G., & Özbağ, G. K. Leadership and Creativity: The Impact of Transformational Leadership on Individual Creativity. *Procedia-Social and Behavioral Sciences*. 2016; 235: 243-249.
- [5] Jyoti, J., & Dev, M. The impact of transformational leadership on employee creativity: the role of learning orientation. *Journal of Asia Business Studies* 2015; 9 (1): 78-98.
- [6] Li, C., Zhao, H., & Begley, T. M. Transformational leadership dimensions and employee creativity in China: A cross-level analysis. *Journal of Business research*. 2015; 68 (6): 1149-1156.
- [7] Qu, R., Janssen, O., & Shi, K. Transformational leadership and follower creativity: The mediating role of follower relational identification and the moderating role of leader creativity expectations. *The Leadership Quarterly*. 2015; 26 (2): 286-299.
- [8] Pretorius, M., Millard, S. M., & Kruger, M. E. The relationship between implementation, creativity and innovation in small business ventures. *Management Dynamics*. 2006; 15 (1): 2-13.
- [9] Khedhaouria, A., Gurau, C., & Torrès, O. Creativity, self-efficacy, and small-firm performance: The mediating role of entrepreneurial orientation. *Small Business Economics*. 2015; 44 (3): 485-504.
- [10] Ahlin, B., Drnovsek, M., & Hisrich, R. D. Entrepreneurs' creativity and firm innovation: The moderating role of entrepreneurial self-efficacy. *Small Business Economics*. 2014; 43(1): 101-117.
- [11] The department of agricultural extension. *Agricultural Statistics in nakhonpathom* [Internet]. 2015 [cited 10 Sep 2016]. Available from <http://www.nakhonpathom.doae.go.th>.
- [12] Yamane, T. *Statistics: an introductory analysis*. New York: Harper and Row; 1973.
- [13] Cronbach, L. J. My current thoughts on coefficient alpha and successor procedures. *Educational and Psychological Measurement*. 2004; 64 (3): 391-418.
- [14] Johnson-Conley, C. D. *Using community-based participatory research in the development of a consumer-driven cultural competency tool* [dissertation]. University of Washington; 2009.
- [15] Hair, J. F., Black, W. C., Babin, B. J. & Anderson, R. E. *Multivariate data analysis*. 7<sup>th</sup> ed. Upper Saddle River, NJ: Pearson Prentice Hall; 2010.



# Determinants of Happiness in a Multicultural Setting: A Case of Chana District, Songkhla Province, Thailand

Nurainee Jangoe<sup>1,3,\*</sup>, Sarawuth Chesoh<sup>2</sup> and Apiradee Lim<sup>1</sup>

<sup>1</sup>Department of Mathematics and Computer Science

<sup>2</sup>Department of Science, Faculty of Science and Technology,  
Prince of Songkla University, Pattani Campus, 94000 Thailand

<sup>3</sup>Centre of Excellence in Mathematics, CHE, Si Ayutthaya Rd., Bangkok 10400, Thailand

## Abstract

Happiness is a psychological concept that has an impact on people's life in different aspects. The aim of the study was to identify the determinants of happiness among the multicultural residents in Chana district of Songkhla province in Thailand. Data were obtained from the annual monitoring database on socioeconomic and attitude of people inhabiting around EGAT's Chana Power Plant from 2010 to 2016. A total of 2,864 sample households from 45 communities were individually interviewed to evaluate the mental health of the respondents by using the Thai Happiness Indicators (THI-15) questionnaire of the Department of Mental Health, Ministry of Public Health. The determinants of happiness were identified by using multiple linear regression. The results showed that the overall mean of happiness index score was 30.24. There were significant relationship between happiness index score and survey year, place of living, occupation and income of residents ( $p$ -value  $< 0.05$ ). In conclusion, happiness of residents was mainly determined by time, place and economic status.

**Keywords:** Happiness score, Community psychology, Multicultural society, Thailand

## 1. Introduction

Happiness is defined as central human stimuli and a vital goal for all human generations [1]. It is a state of emotion and affection characterized by feelings of satisfaction and enjoyment. It is also related to well-being, life satisfaction, successful aging and good quality of life [2]. Being happy often leads to better health, longer life, decrease in disabilities and reduce mortality [3, 4].

From the current world happiness report [5], the top 10 countries with the highest happiness indices are Norway, Denmark, Iceland, Switzerland, Finland, Netherlands, Canada, New Zealand, Australia and Sweden. All these countries are developed countries, with 7 in Europe. On the other hand, developing countries (mostly in Africa and Asia) are documented with the least happiness levels [5]. Singapore and Thailand have remained the top two countries with high happiness levels in the Association of Southeast Asian Nations (ASEAN) region over the past 4 years [5, 6]

There have been documented evidence to show that age, gender, income level, marital status, occupation, place of domicile, education and religious belief affect the happiness levels among different groups of people [7, 8, 9, 10].

The Chana district in the Songkhla province of Thailand could be considered as a multicultural area. The inhabitants are exposed to cultural diversity by the presence of different religions such as Islam, Buddhism and Christianity. The district, which is in the Songkhla province has many industries, organizations and factories. It has given the Chana district diverse occupations such as agriculture, merchant, fishing and others. This exposure is likely to affect the way of life and happiness level of the communities in the district. This present study aimed to identify the factors that influence happiness among residents in Chana district.

## 2. Research objectives

2.1 To investigate the level of happiness index of the residents in Chana district, Songkhla province, Thailand.

2.2 To identify factors that influence happiness index of the residents in Chana district, Songkhla province, Thailand.

---

\* Corresponding author; e-mail: nurainee.jangoe@gmail.com

### 3. Materials and methods

#### Study areas, Data source and variables

This study employed secondary data based on socio-economic factors and happiness index score of residents around the Chana power plant. These data were obtained from Electricity Generating Authority of Thailand (EGAT). A cross-sectional study was conducted from 2010 to 2016. The study area comprised of 7 sub-districts out of 14 sub-districts in the Chana district of Songkhla province, Thailand which are Ban Na, Na Wa, Klong Pia, Taling Chan, Chanong, Paching and Na Thap. The inclusion criteria for the selection of these seven sub-districts was based upon their distance away from the Chana power plant. The distance considered in this study is almost 5km. We assume that sub-districts closer to the power plant have more effect in terms of happiness than sub-districts outside the defined distance range.

The subjects were selected using systematic random sampling technique. A convenience sampling was used in the ease of difficulty of getting samples. A total of 2,864 subjects (393 subjects in 2010, 404 subjects in 2011, 451 subjects in 2012, 407 subjects in 2013, 389 subjects in 2014, 410 subjects in 2015 and 410 subjects in 2016) were interviewed.

The tool used in the study was the Thai Happiness Indicators questionnaire developed by the Department of Mental Health under the Ministry of Public Health [12]. The tool consist of 15 questions and each question has 4 choices: not at all (0 score), little (1 score), much (2 scores) and very much (3 scores). The total score for Thai happiness index score is 45. The scores ranged from 35 to 45 marks means the Happiness Indicator is higher than the general people, 28 to 34 marks means equal to general people and 0 to 27 marks means lower than general people[12].

#### Variables

##### Outcome variable

In this study, the outcome variable is happiness index score.

##### Determinants

The determinants in this study are survey year, place of living, age group, gender, occupation, education, income, religion, duration of resident (years).

Place of living consist of 7 groups namely Ban Na, Na Wa, Klong Pia, Taling Chan, Chanong, Paching and Na Thap. Survey years consist of 7 years: 2010, 2011, 2012, 2013, 2014, 2015 and 2016. Age was divided into 5 groups: 18-35 years old, 36-45 years old, 46-55 years old, 56-65 years old and >65 years old. Gender was grouped into male and female. Occupation was divided into 4 groups: agriculture, employee, seller and others. Education level was divided into 2 groups: lower or equal primary school and higher than primary school. Family income per month was classified into 2 groups: lower or equal 9,000 Baht and more than 9,000 Baht. We assume that 9,000 Baht is the lowest rate that can be earned monthly by people working in this district. Religion was divided into 2 groups: Islam and Buddhism. Duration of resident was divided into 3 groups namely ≤25 years, 26-50 years and >50 years.

#### Statistical methods

A preliminary statistical analysis involved examining the frequency distribution of the independent variables. The happiness index score for each group of determinants was compared using the two-sample t-test for a dichotomous determinant and F-test for a multi-categorical determinant. The significant variables, identified in the univariate analysis were further examined using multiple linear regression to identify the strength of relationship between determinants and outcome. Statistical significance was set at p-value <0.05. All statistical analysis was carried out using R program [11].

### 4. Results and discussion

Figure 1 explains about demographic of respondents. The percentage of samples in each year from 2010, 2011, 2012, 2013, 2014, 2015 and 2016 were 13.7%, 14.1%, 15.8%, 14.2%, 13.6%, 14.3% and 14.3%, respectively (Figure 1a). The majority of respondents were living in Na Thap (NT) sub-district (27.1%) (Figure 1b). Most of respondents were female (62.5%) (Figure 1c). The majority of the respondents with the highest religious representation were Islam (62.7%) followed by Buddhism (37.3%) (Figure 1d). The age of the respondents ranges 18 to more than 65 years. The highest age group was between 36-45 years (27.1%) and the lowest age group was more than 65 years (7.9%) (Figure 1e). Over 45.6% of respondents had been settled in their village between 26- 50 years (Figure 1f). Approximately 59.1 % of respondents had education level primary school or lower (Figure 1g). Agriculture was the main occupation accounted for with 48.5%, employee accounted for 23.2% and seller with 17.7% (Figure 1h). The respondents had monthly income more than 9,000 Baht per month accounted for 70.7% (Figure 1i).

Happiness index score of people was assessed by the questionnaire and classified the score into three levels compared to the standard happiness index score reported for the whole of Thailand by the Department of

Mental Health, Ministry of Public Health [12]. The happiness index score of Thai people ranged between 28 and 34 scores, therefore, this score was considered as the average score of happiness.

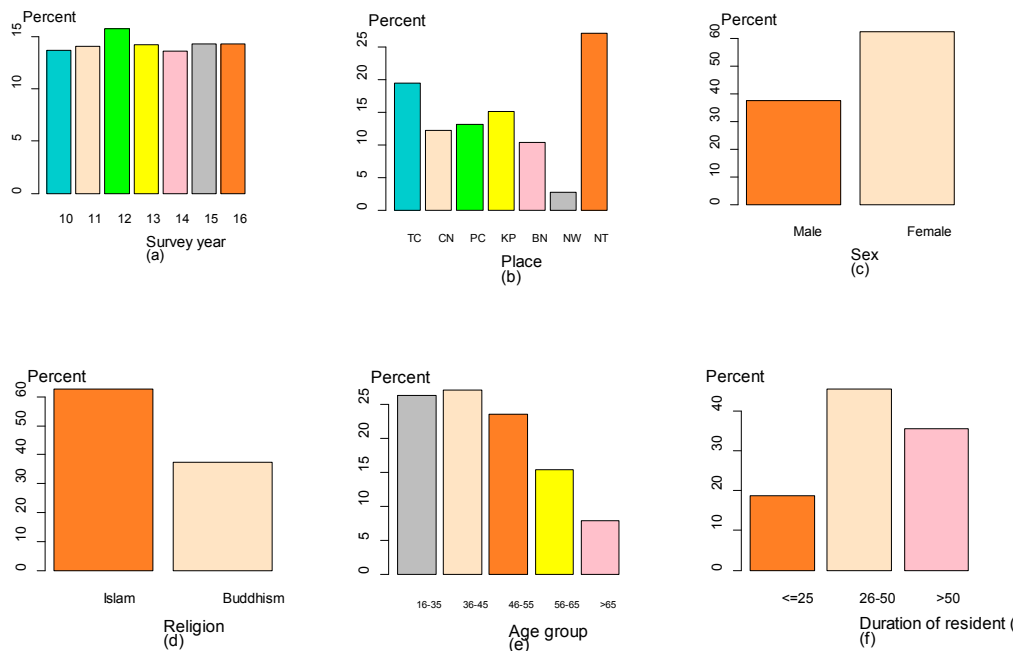
The results of this study showed that half of the respondents (52.3 %) had an average level of happiness followed by 21.0 % of the respondents' happiness level was above average while 26.7 % had happiness level below average (Table 1).

Table 2 indicates preliminary results explaining that survey year, place of living, occupation and income are statistically significant. We conclude that the happiness index score are different for each of these determinants.

Table 3 Coefficient and standard errors of multiple linear regression on happiness index score. The model shows that happiness index score and survey year, place of living, occupation and income are statistically significant with p-value less than 0.05. This result is consistent with the results from a study conducted by department of Mental Health, National Statistical Office of Thailand and Institute for Population and Social Research of Mahidol University in 2015 [13]. The study found that there was a very small change in happiness level of Thai people between 2014 and 2015 from 31.52 to 31.44 [13].

Occupation was an important factor influencing happiness. We found that people with other occupation (civil servants and self-employed) had higher happiness index score compared to agricultural workers, seller and employees. The lowest happiness index score was recorded among employees. Other studies had confirmed the existence of a relationship between type of occupation and happiness [14].

This study also revealed that happiness index depended on income levels. Respondents with monthly income more than 9,000 Baht had higher happiness index score than those with monthly income 9,000 Baht or less. This is corroborated by the report of Yiengprugsawan et al., (2012) [15], which stated that household income levels could determine that level of happiness. Despite the fact that some studies had shown that happiness was associated with age, gender, education and religion [16,17] However, in our study found that there were no statistically significant association between happiness index score and age group, gender, education, religion and duration of residents.





**Figure 1** Distribution of demographic factors

**Table1** Level of happiness of people in Chana district, Songkhla province, Thailand

Level of happiness	Number (n=2,864)	Percentage
Below average level of happiness	767	26.7
Average level of happiness	1497	52.3
Above average level of happiness	600	21.0

**Table 2** The statistical significance of associations

Determinant	Statistical Valued	p-value
Survey year	F-statistic : 63.845	0.0000
Place of living	F-statistic : 2.643	0.0147
Age group	F-statistic : 2.242	0.0622
Gender	t-statistic : 1.639	0.1014
Occupation	F-statistic : 3.115	0.0252
Education	t-statistic : 1.142	0.2537
Income	t-statistic : 6.405	0.0000
Religion	t-statistic : 0.658	0.5107
Duration	F-statistic : 0.942	0.3901

**Table 3** Coefficient and standard errors of multiple linear regression on happiness index score

Variable	Coefficient (95% CI)	standard errors (SE)	p-value
<b>Constant</b>	30.2416201	0.0968	
<b>Survey year</b>			<0.001
2010	(0)		
2011	2.1784407	0.2489	
2012	2.9480069	0.2434	
2013	-1.7630331	0.2259	
2014	2.0646288	0.2410	
2015	-0.2574708	0.2477	
2016	-2.8481875	0.2425	
<b>Place of living</b>			<0.001
Talingchan	(0)		
Chanong	0.6641486	0.1994	
Paching	-0.2698519	0.2629	
Klong Pia	0.5848071	0.2542	
Ban Na	-0.2523648	0.2380	
Na Wa	0.8862567	0.2978	
Na Thap	0.6770821	0.5868	
<b>Occupation</b>			<0.05
Agriculture	(0)		
Employee	0.1054269	0.1037	
Seller	-0.3645226	0.1856	
Others	-0.2051636	0.2120	
<b>Income</b>			<0.001
<=9,000Baht	(0)		
> 9,000Baht	-0.9984984	0.1588	

## 5. Conclusions

Happiness of residents in the study area was mainly determined by time, location and economic status. Happiness is an important indicator represent quality of life among residents in Chana district, Songkhla province. Therefore, happiness of people should be considered before setting up any policies or programs related to locals living conditions.

## Acknowledgements

We gratefully acknowledge the Electricity Authority of Thailand (EGAT) for providing the data. We are also grateful to Emeritus Professor Don McNeil for his helpful advice and valuable suggestions. This research is (partially) supported by the Centre of Excellence in Mathematics, the Commission on Higher Education, Thailand and also by the Graduate School, Prince of Songkla University, Thesis Funding.

## References

- [1] Steptoe A, Wardle J, Marmot M. Positive affect and health-related neuroendocrine, cardiovascular, and inflammatory processes. *Proceedings of the National Academy of Sciences*. 2005; 102: 6508–6512.
- [2] Miller, C. A. *Nursing for Wellness in Older Adults: Theory and Practice*. 4<sup>th</sup> ed. Philadelphia: Lippincott Williams and Wilkins; 2004.
- [3] Collins, A. L., Goldman, N., Rodriguez, G. Is positive well-being protective of mobility limitations among older adults?. *The Journals of Gerontology Series B: Psychological Sciences and Social Sciences*. 2008; 63: 321-327.
- [4] Danner, D. D., Snowden, D. A., Friesen, W. V. Positive emotion in early life and longevity: Finding from the Nun Study. *Journal of Personality and Social Psychology*. 2001; 80: 804-813.
- [5] Helliwell, J.F., Layard, R., Sachs, J. *World Happiness Report 2017*. 1<sup>st</sup>. New York: Sustainable Development Solutions Network; 2017.
- [6] Helliwell, J.F., Layard, R., Sachs, J. *World Happiness Report 2016*. 1<sup>st</sup>. New York: Sustainable Development Solutions Network; 2016.

- [7] Yang, Y. Social inequalities in happiness in the United States, 1972 to 2004: An age-period-cohort analysis. *American Sociological Review*. 2008; 73: 204-226.
- [8] Diener, E., Suh, E. M., Lucas, R. E., Smith, H. L. Subjective well-being: Three decades of progress. *Psychological Bulletin*. 1999; 125: 276-302.
- [9] Layard, R. *Happiness: Lessons from a new science*. 1<sup>st</sup>. New York: Penguin Press; 2005.
- [10] Blanchflower, D.G, Oswald, A.J. Well-being over time in Britain and the USA. *Journal of Public Economics*. 2004; 88: 1359-1386.
- [11] R Development Core Team. A language and environment for statistical computing [Internet]. 2015. [cited April 18 2016]. Available from: <http://www.R-project.org>
- [12] Mongkol, A., Hattaprom, W., Chedchoksuk, P., Chalowkul, W., Phayoyai, L. Thai Happiness Indicators (THI – 15) [Internet]. 2002. [cited December 17 2016] Available from: <http://www.dmh.go.th/test/download/files/thi15.pdf>
- [13] National Statistical Office of Thailand. Mental Health Survey (Happiness) Thai people 2015 [Internet]. 2015. [cited January 17 2017] Available from: [http://service.nso.go.th/nso/nsopublish/themes/files/mental-healthm\\_jul\\_58.pdf](http://service.nso.go.th/nso/nsopublish/themes/files/mental-healthm_jul_58.pdf)
- [14] Mehrdadi, A., Sadeghian, S., Direkvand-Moghadam, A., Hashemian, A. Factors affecting happiness: a cross-sectional study in the Iranian youth. *Journal of Clinical and Diagnostic Research*. 2016; 10: 1-3.
- [15] Yiengprugsawan, V., Somboonsook, B., Seubsman, S., Sleigh, A.C. Happiness, mental health, and socio-demographic associations among a national cohort of Thai adults. *Journal of Happiness Studies*. 2012; 13: 1019-1029.
- [16] Frey, B.S., Stutzer, A. What can economists learn from happiness research?. *Journal of Economic Literature*. 2002; 40: 402-435.
- [17] Tiefenbach, T., Kohlbacher, F. Happiness and life satisfaction in Japan. *German Institute for Japanese Studies (DIJ)*. 2013; 13 (1): 121.

# The Comparative Study of Logistics Cost Structure for Farmers' Siamese Fighting Fish

Hirannapat Minmantra<sup>1,\*</sup>, Sukcharoenpong Sompon<sup>1</sup>, and Ditsathaporncharoen Santi<sup>1</sup>

<sup>1</sup>Faculty of Management Science, Nakhon Pathom Rajabhat University

## Abstract

The purposes of this study were 1) to study logistics cost structure, and 2) to compare logistics activities classified by fish amount. The sample were 99 farmers. The questionnaire was used as the tool for data collection. The data was analyzed in term of frequency, percentage, means, standard deviation, minimum, maximum, One – way ANOVA, and Scheffe method. The results showed that logistics cost structure for farmers' Siamese Fighting fish consisted of two logistics activities including purchasing the input supplies and preparing the delivery. Logistics cost structure for farmers' Siamese fighting fish was 74,081.93 baht per year. The highest logistics cost was transportation for purchasing the input supplies. Moreover, Communication with buyers which is the lowest logistics cost. Furthermore, farmers with different fish amount had no the different level in logistics activities. Farmers with different fish amount had the different level in preparing the delivery with the statistical significance at .05 level.

**Keywords:** Siamese Fighting fish, logistics cost structure, logistics activities

## 1. Introduction

In 2015, Thailand is the seven largest exporters in the world. The total value of exports is US\$15.67 million, with a market share of 5.1 percent percentage of global [1]. Siamese fighting fish is favorite ornamental fish export from Thailand. The amount of export to global is 87,403 kilograms, value is 55,160,638 million baths [2]. Siamese fighting fish export to many countries such as Singapore, United States of America, China, Japan, etc.

The logistics cost is an important factor to manage Siamese Fighting fish Farm. Farmers should manage and control logistic cost because they will take competitive advantage. Moreover, customers satisfy and profit increase. The logistics cost structure consists of the activities of procurement, material handling, transportation, inventory, and customer communications [3]. The logistics cost depends on by farm size. Therefore, we investigate the comparative study of logistics cost structure for farmers' Siamese fighting fish. The objectives of this study are to study logistics cost structure, and compare logistics activities classified by fish amount. This study contributes to understanding of logistics cost. In addition, farmers can decide to choose suitable fish amount.

## 2. Objectives

1. To study logistics cost structure.
2. To compare logistics activities classified by fish amount

## 3. Review literature

The definition of logistics cost structure was entrepreneur activities cost such as purchasing, handling, inventory, serving [4] Logistics cost structure referred to resources allocation cost from supplier to customer [5]. [6] showed that logistics cost structure included procurement, material handling, transportation, inventory, and customer communications. Logistics cost structure had the different level classified by the size of farms. The logistics cost structure included procurement, material handling, transportation, inventory, customer service, and communications. The logistics costs varied by farm size. For example, farmers with small, medium and large size had the different level of material handling costs or preparing the delivery [3].

## 4. Methods

### The population and sample

The population were 131 farmers in Nakhon Pathom Province 2015 [7].

The sample were 99 farmers by using Yamane formula [8].

---

\* Corresponding author; e-mail: minmantra@webmail.npru.ac.th

The questionnaire was used as the tool for data collection. The questionnaire consisted of two parts including demographic characteristics, and logistics cost structure. Three experts verified the content validity. The experts included academic and experienced farmers. Item of objective congruence index were more than 0.5. For reliability test, Cronbach's alpha coefficient were more than 0.70 [9].

#### Data analysis

The data was analyzed in term of frequency, percentage, means, standard deviation, minimum, maximum, One – way ANOVA, and Scheffe method.

### 5. Results

The results are presented in three parts as followings: demographic characteristics, descriptive statistics of logistics cost structure, One – way ANOVA, and Scheffe method.

#### Demographic characteristics

In the study, the majority of farmers, 69 (69.70%) were male, 32 (32.32%) were between the ages of 41 – 50 years, and 56 (56.57%) were elementary school. 46 (46.47%) of farmers had experience between 15 – 21 years and 61 (61.62%) of farmers had fish amount less than 50,000 fish. Demographic characteristics are shown in Table 1.

**Table 1** Demographic characteristics

Descriptions	Frequency	Percentage
Gender		
Female	30	30.30
Male	69	69.70
<b>Total</b>	<b>99</b>	<b>100</b>
Age		
21 years and Lower	5	5.05
21 – 30 years	8	8.08
31 – 40 years	27	27.28
41 – 50 years	32	32.32
51 – 60 years	17	17.17
60 years upper	10	10.10
<b>Total</b>	<b>99</b>	<b>100</b>
<b>Education Level</b>		
Elementary School	56	56.57
Junior High School	27	27.27
Senior High School	9	9.09
Vocational Diploma	2	2.02
Bachelor degree	5	5.05
Upper than bachelor degree	0	0.00
<b>Total</b>	<b>99</b>	<b>100</b>
Experience		
1 – 7 years	0	0.00
8 – 14 years	29	29.29
15 – 21 years	46	46.47
22 – 28 years	14	14.14
29 – 35 years	6	6.06
More than 35 year	4	4.04
<b>Total</b>	<b>99</b>	<b>100</b>
Siamese Fighting fish owned by farmers		
Fewer than 50,000 fish	61	61.62
50,000 – 100,000 fish	25	25.25
100,001 – 150,000 fish	4	4.04
150,001 – 200,000 fish	3	3.03
200,001 – 250,000 fish	6	6.06
More than 250,000 fish	0	0.00
<b>Total</b>	<b>99</b>	<b>100</b>

#### Descriptive statistics of logistics cost structure

Logistics cost structure for farmers' Siamese Fighting fish consisted of two logistics activities including purchasing the input supplies and preparing the delivery. Purchasing the input supplies comprises



communication with suppliers and transportation for purchasing the input supplies. In addition, preparing the delivery comprises communication with buyers, material, equipment and packaging for preparing the delivery, and labor for preparing the delivery.

Logistics cost structure for farmers' Siamese fighting fish was 74,081.93 baht per year. The highest logistics cost is transportation for purchasing the input supplies which was 39,334.55 baht per year. Moreover, Communication with buyers which was the lowest logistics cost is 4,514.79 baht per year. Descriptive statistics of logistics cost structure are shown in Table 2.

**Table 2** Descriptive statistics of logistics cost structure

Logistics Activities	Logistics Cost (Baht/Year)	Standard Deviation	Minimum	Maximum
<b>1. Purchasing the Input Supplies</b>	43,970.55	68,025.41	3,000.00	484,800.00
1.1 Communication with Suppliers	4,636.00	3,193.00	600.00	21,600.00
1.2 Transportation for Purchasing the Input Supplies	39,334.55	67,621.30	2,400.00	480,000.00
<b>2. Preparing the Delivery</b>	30,111.37	22,480.58	8,686.76	150,540.00
2.1 Communication with Buyers	4,514.79	3,264.87	400.00	21,600.00
2.2 Material, Equipment and Packaging for Preparing the Delivery	5,342.04	2,153.00	286.76	9,965.50
2.3 Labor for Preparing the Delivery	20,254.55	21,428.76	7,200.00	132,000.00
<b>Total Costs of Logistics Activities</b>	74,081.92	73,271.44	15,166.76	531,042.00

#### **A comparative study of logistics activities classified by fish amount**

The results indicated that farmers with different fish amount had no the different level in logistics activities. Nevertheless, farmers with different fish amount had the different level in preparing the delivery with the statistical significance at .05 level. A comparative study of logistics activities classified by fish amount are shown in Table 3.

**Table 3** A Comparative Study of logistics activities classified by fish amount

Logistics Activities	F	Sig
1. Purchasing the Input Supplies	.849	.498
2. Preparing the Delivery	8.075*	.000
<b>Total Costs of Logistics Activities</b>	.444	.776

\* p < .05

#### **Post Hoc Tests**

A comparative study of preparing the delivery classified by fish amount with Scheffe method are shown in Table 4. Farmers with less than 50,000 fish, and 200,001 – 250,000 fish had the different level in preparing the delivery. Farmers with 50,000 – 100,000 fish, and 200,001 – 250,000 fish had the different level in preparing the delivery. In addition, farmers with 150,001 – 200,000 fish and 200,001 – 250,000 fish had the different level in preparing the delivery.

**Table 4** Post Hoc Tests

Fish Amount		Lower than 50,000 fish	50,000 – 100,000 fish	100,001 – 150,000 fish	150,001 – 200,000 fish	200,001 – 250,000 fish
	Mean	24,940.97	25,300.00	30,604.22	50,382.50	69,515.20
Less than 50,000 fish	24,940.97	-	-	-	-	-44,574.23*
50,000 – 100,000 fish	25,300.00		-	-	-	-38,910.98*
100,001 – 150,000 fish	30,604.22			-	-	-19,132.70
150,001 – 200,000 fish	50,382.50				-	-44,215.20*
200,001 – 250,000 fish	69,515.20					-

\* p &lt; .05

## 6. Discussion

In this study, logistics cost structure for farmers' Siamese Fighting fish consisted of two logistics activities including purchasing the input supplies and preparing the delivery which was in accord with the previous research [3], [6]. Farmers with different fish amount had the different level in preparing the delivery with the statistical significance at .05 level which was in accord with the previous research. [3]

## 7. Conclusions

The results from this research indicated that logistics cost structure for farmers' Siamese Fighting fish consisted of two logistics activities including purchasing the input supplies and preparing the delivery. Logistics cost structure for farmers' Siamese fighting fish was 74,081.93 baht per year. The highest logistics cost was transportation for purchasing the input supplies which is 39,334.55 baht per year. Moreover, Communication with buyers which is the lowest logistics cost was 4,514.79 baht per year. The results indicated that farmers with different fish amount had no the different level in logistics activities. Nevertheless, farmers with different fish amount had the different level in preparing the delivery with the statistical significance at .05 level. Farmers should plan transportation to decrease cost and control preparing the delivery cost.

## References

- [1] Factfish Reserch. Thailand: Ornamental fish, live, export value (US \$)[Internet]. 2015. [cited 10 Aug 2017]. Available from <http://www.factfish.com>.
- [2] Fisheries trade statistics of Thailand. Fisheries trade statistics annual report 2015. 2015; p. 103.
- [3] Srisaeng, O., Chaveesuk, R., Suwandeochai, R., & Ongkunaruk, P. Analysis of production costs and logistics costs of white shrimp farming in Thailand. In Proceedings of the 48th Kasetsart University Annual Conference. 2010; 3-5 March.
- [4] Stępień, M., Łęgowik-Świącik, S., Skibińska, W., & Turek, I. Identification and Measurement of Logistics Cost Parameters in the Company. Transportation Research Procedia. 2016; 16: 490-497.
- [5] Christopher, M. Logistics & supply chain management. UK: Pearson Prentice Hall; 2016.
- [6] Ongkunaruk, P., & Piyakarn, C. Logistics cost structure for mangosteen farmers in Thailand. Systems Engineering Procedia. 2011; 2: 40-48.
- [7] Department of Fisheries in Nakhon Pathom Province. 2016.
- [8] Yamane, T. Statistics: an introductory analysis. NY: Harper and Row; 1973.
- [9] Cronbach, L. J. My current thoughts on coefficient alpha and successor procedures. Educational and Psychological Measurement. 2004; 64(3): 391-418.

# Developing Intrinsic Reward System in Digital Era of Chandrakasem Rajabhat University: Discursive Practice to Social Reproduction

Chonticha Tippratun<sup>1,\*</sup>

<sup>1</sup> Faculty of Management Science Chandrakasem Rajabhat University

## Abstract

This is a qualitative research with the aims to create 1) a discourse on developing intrinsic reward system in digital era of Chandrakasem Rajabhat University and 2) a social reproduction in discursive practice and social practice on developing intrinsic reward system in digital era of Chandrakasem Rajabhat University by using the discourse analysis of Norman Fairclough. The key informants are 19 managements in Chandrakasem Rajabhat University and using purposive and snowball techniques. The data was collected by in-depth interviews and analyst from text, discursive practice and social practice.

The findings revealed that a University focused on encouraging process of employee's intrinsic reward via an empowerment both formal and informal practice, which based on using social media that under a supervision of a University. In addition to a University allow to the related department to data screening before disseminating to social context to build a credibility on data and recognize to people. All these bring a University to have a solid to retain a human resource in extremely competition on education industry.

**Keywords:** Intrinsic Reward System, Digital Era, Discursive Practice, Social Reproduction

## 1. Introduction

During a dynamic changing on conceptual paradigm in digital era, technology is a key role in all process, many problems has to be addressed in order to closed a human gap such as inconsistent problem between the factor that employees need and the factor that offer by organization which related with social exchange theory. [1-2] So, many organizations try to using an efficiency tools of sustainable human resource management. Since nowadays, a human thinking leads by technology, hence a human need to learn and develop themselves for having a necessary skill, feature with a capability needed to cope with the actual fast changing, but at the same time, data - rich environment. [3] Using technology wisely become to the key success factor and affect to human resource management process in digital era. Because, the human can perceive data and information from online social media which convenient and faster than before. So, an empowerment by using a technology intelligently to approach required information are important that human desire. Whenever they satisfied on the empowerment, then they will tend to perceive an intrinsic reward which is a tool of decreasing an attrition rate. [4]

All of these, it is can be clearly seen that all organization need a develop their intrinsic reward system through an empowerment process because, nowadays the human needs more money or other incentives that stimulate them only in short time. Intrinsic reward is an important alternative to fixed challenges gap, because when an employee perceives this kind of reward, a workplace will become like a second house and colleague as a family [5] also as a key factor to make employee have well-being. [6]

Accordingly, to make an understanding on phenomenon required interpretation deeply and sharply, led to the application of the intrinsic reward system in digital era tangibly need an experienced and expert people to disclose their perspectives. In order to open the social space, a qualitative research used by discourse analysis led to discursive practice and social practice.

## 2. Research objectives

2.1 To study a discourse on developing intrinsic reward system in digital era of Chandrakasem Rajabhat University.

---

\* Corresponding author; e-mail: aj.chonticha@gmail.com

2.2 To study a social reproduction in discursive practice and social practice on developing intrinsic reward system in digital era of Chandrakasem Rajabhat University.

### 3. Methods

#### 3.1 Research design

This is a qualitative research by using a discourse analysis method of Norman Fairclough [7] including text, discursive practice and social practice. To build a discursive practice for social reproduction of intrinsic reward system in digital era through in-depth interview.

#### 3.2 Research Area

**1) The content framework**, to get to understand the intrinsic reward system in digital era which able to divide to be 4 factors as per Tippratum [4,8] Tymon, Stumpf and Doh [9] stated follows;

**1.1) Meaningfulness**, this reward involves the meaningfulness or importance of the purpose that employee are trying to fulfill, they feel have an opportunity to accomplish something of real value.

**1.2) Competence**, this reward involves encouraging their efforts are really accomplishing something and they see convincing signs that things are working out, giving they confidence in the choices they have made and confidence in the future.

**1.3) Recognition and praise**, this reward involves they get the recognition in performance as well as receive the praise in their ability from colleagues, supervisors and others openly or give award to represents a success. As a result, they feel a sense of satisfaction and pride as well as make them have self - confidence in the future.

**1.4) Achievement**, this reward involves they working had achieved and succeed in working objective and they feel accomplish, ownership and responsibility in their work including believe in the approach they are used.

**2) The area frameworks**, the researcher studied with junior management to top management in Chandrakasem Rajabhat University who have experiences and expertise in human resource management and understand of essence in human needs in bureaucratic structures as well.

**3) Timing framework**, the researcher collects the data between May to July 2017.

#### 3.3 Key informants and theoretical sampling

The researcher select the key informants and theoretical sampling by consistency and relationship with research objective total 19 persons, focus on since junior management to top management that working in Chandrakasem Rajabhat University who have experiences and expertise in human resource management. the researcher selects a sampling by purposively which based on logically and reasonably.

#### 3.4 Research instruments

The researcher prepares the research questions guideline by use semi-structured interview which classified as 3 sessions: text, discursive practice and social practice about intrinsic reward system in digital era, which each sessions has contains the questions about; 1) the meaning of intrinsic reward, 2) the elements of intrinsic reward, 3) the influent factors to make the employee receive intrinsic reward, 4) how to motivate employees to receive intrinsic reward and 5) how to create a continuation of the practice. In addition the researcher use voice recorder, camera, and review literature to support researcher to get on theoretical sensitivity.

#### 3.5 Data collection

A collecting data include 2 steps follows, 1) literature reviewing and empirical evident to make question guideline and 2) in-depth interview, before interview execution, an interviewing has to get acceptance from key informants before commencing a question to respect the human rights under the 3 basic ethical principles including; informing consent, data confidentiality and prevention of potential effects on data providers. [10]

#### 3.6 Research validation and reliability

The researcher using a data triangulation to validate a data reliability when get a different sources, which mean the difference key informants that have working in Chandrakasem Rajabhat University in junior management to top management position [10] in order to confirm a data are trustable and fond theoretical conclusion.

#### 3.7 Data manipulate and analysis

**1) Data manipulate.** The research focus on qualitative method from study the patterns and methods by carefully as well as data collection, data manipulate, data analysis and result under selection of appropriate tools to collect data. Which this is a qualitative research by using a discourse analysis method of

Norman Fairclough [7] including text, discursive practice and social practice thru strict collection and analysis process as well as systematically interpret and scrutinize. For qualitative research, the researcher is the most important, so have studied about concept, theory and empirical evident in order to get theoretical sensitivity. Also have built information reliability by data triangulation.

By the way, the researcher use the knowledge from behavioral sciences as a basic for learning verbal and non-verbal in order to understanding and interpreting the data from each phenomenon. However, to make all process for interviewing has are carefully and properly, the research use voice recorder and take photos together. All of these, beginning from creating trust climate and good relationship between interviewer and interviewee without bias and guide under the principle of respect for human rights.

**2) Data analysis.** The research focus on data analysis plan, because it has effect to theoretical conclusions include; [10-11]

**2.1) Data organizing** are the step to make the date form in-depth interview has systematic and convenience for accessing and using. By verbatim the data obtained from record while interviewing, after that the researcher will determine coding for classifying all data and group data with the same or similar meaning to the same code.

**2.2) Data connection** are the step to link each data code to make a group under compatibility theme, which the researcher identify 3 groups of analysis including; text, discursive practice and social practice about intrinsic reward system in digital era. These makes to get concept for describing phenomena at a certain level.

**2.3) Integration data into stories** are the step to find summary under concept relationship according to empirical data until theoretical saturation in order to create text, discursive practice and social practice of developing intrinsic reward system in digital era of Chandrakasem Rajabhat University.

#### 4. Results and discussion

##### 4.1 Discourse of intrinsic reward system development in digital era of Chandrakasem Rajabhat University

4.1.1 From the analyze text of intrinsic reward system development in digital era of Chandrakasem Rajabhat University found that;

Chandrakasem Rajabhat University has promoted and encouraged the employees to perceive intrinsic reward continuously of all transitions of social and technological systems. Due to a University recognizes an importance of human resource development to valuable person thru self-esteem is a valuable asset, which clearly stated in a University's strategic plan in many eras. But the past might not be clear, because intrinsic rewards are subjective and difficult to understand. The key point is intrinsic reward is difficult to buildup, if the employees haven't feel loyalty to a University truly.

An antecedent that a University focused on developing intrinsic reward system, because a University recognize that human resources are mainspring to drive vision's University. Even in digital era that all social context emphasizes to use technology as a guide in moving forward. However, technology will have efficiency when human have a knowledge, understanding and readiness to use. Consequently, if human resources got a hegemony by technology, morale must be retreated. So, a key of stimulating intrinsic reward's employees under acceptance the humanity's value in the world of rapid technological change is the empowerment both formal and informal types for accessing to necessary information and promote to be leader.

Attributed to rapid changes in digital era, the employee with critical skill become a valuable assets that a University needs retention. Especially for employee who has desire on self-demanding than monetary factors which influence to motivate them. As a result, motivation, attraction, and retention them by extrinsic reward such as money and fringe benefits for encouraging efforts and decrease dis-satisfaction, may not be sufficient and sustainable. Because an employee will be response to reward only they needed. Therefore, Motivating by intrinsic rewards are increasingly important in human resources management process, by reason of it's contributes to retention efficient employees as well as decrease intention rate. Accordingly, a University focused on support employees to receive intrinsic reward, classified into 5 factors according to priority as follow;

1) Sense of recognition; A University recognize in skills and abilities through empowerment by giving a chance to decision in critical work, trust and confident in working as well as support to employee's requirement. Although in practice found that,

*Somporn (pseudonym) [12] say that “a University operating under bureaucratic structure, accepting some cross-functional employees might be difficult. So, A University is trying to develop recognition system in informal form.”*

2) Sense of responsibility; A University contribute employees to have feeling ownership in working style and their output, as well as giving a chance to take responsibility for their results neither positive nor negative.

3) Sense of competency; A University assign a challenge work by matching with their abilities, skills and ex-experiences, for reinforcing them to try and seeking a new method to accomplish their work.

4) Sense of achievement; A University show that if an employee has a dedicate and efforts to a University and they perceive it their physical or mental, they can get desire achievement in short time by using an effective performance appraisal method under standard and transparency although in practice found that,

*Sompit (pseudonym) [13] say that “some employees think about performance evaluation system of University without good governance. And the past, a university or some department evaluated under the patronage system. Therefore, a University try to create transparency and add channels to check and monitor.*

5) Sense of obligingness; A University create friendly working climate, without abusing both sexual and social status, as well as to discourage inequality climate from some employees with a superior social class.

It's can be clearly seen that text of intrinsic reward system in digital era can divide to 2 parts which related to each other. In other words, intrinsic reward system in digital era is strengthened when a University have the empowerment to the employees.

4.1.2 From the analyze discursive practice of intrinsic reward system development in digital era of Chandrakasem Rajabhat University found that;

Key issues that motivate employees to perceive on intrinsic reward under rapidly changing of technology is an empowerment both formal and informal, which a university must create the empowerment from the curriculum, faculty up to institutional levels. Especially, leader of all unit has to uphold in same direction and vision, that is “human resources are important mechanism to propel a University along with the way to use ingeniously technology.” Accordingly, each unit has to create social space for showing employee's potential and use social media as a channel for accessing data and information as well as sharing a necessary knowledge from person to person. Which a University have insinuate that;

*Somrak (pseudonym) [14] say that “technology is important, people are the same. If one is missing, it's like a car without a battery.”*

For discursive practice of intrinsic reward system development in digital era of Chandrakasem Rajabhat University has totally 5 factors as follow;

1) Sense of recognition's discursive practice; A University acknowledge in skill and ability of employees through decision empowerment in formal type, such as delegation of authority by appoint them to be a committee in each project and informal type, such as delegation to leader in some situation or special assignment over routine as well as other work that a University assigned. In addition to a University also promote recognition and praise in employee's efficacy by research or project contests etc. The reason to do this because a University wants to honor employees that have ability and make creative until manifested, via social media created by a University, because it's widest and most rapidly spreading news in present.

2) Sense of responsibility's discursive practice; A University use an empowerment via delegation and accountability by clearly which each employee has empirical of ownership such as an appointment order or document record that has been published in a University's information system. These, to build a feeling of ownership including other employees perceive a scope of other's responsibility. However, they have to accept when they do a good work, in turn, they have to confess when their work has a problems or obstacles.

3) Sense of competency's discursive practice; A University analyze a capability of employees systematically on basic knowledge and experience accumulated throughout working experience, for assigning more challenging works. All this will lead to new method and working approach which is called “best practice” that can be transmitted to others to be a guideline for a similar operation. A University would select a knowledge management tools as a channel for empowering to employees to publish their best practice via University's social media, to help everybody can access and absorption best practice for adapting by quickly and easily. As mentioned;

*Sombat (pseudonym) [15] “the employees do not be like a Sled horse that have a cover on his eyes then see only way ahead. Because, they have to learn a new knowledge from internal people. Due to those people working under same environment, problem and politic, therefore, knowledge from people to people is valued and as a treasure.”*

4) Sense of achievement’s discursive practice; A University transform a performance evaluation system of civil servants and university staff in order to evaluate under a same criteria. Because, a University want to empower in equality and decrease social status disparity, which chronic problem in Thai public sector for a long time. As a result, most of university staff has not feel a exploited from civil servants. In addition, a University has open the chance to lecturer can use social network or electronic media in teaching then a University able to use these new teaching methods to be part of performance evaluation, forasmuch in this era, classroom must be more than a classroom and lecturer are the same. Attributed to a University create a transparency under a good governance policy which always state in a master plan, by meeting and communicate all process in evaluation system and criteria to contribute employees with insight and pride in their own evaluation results.

5) Sense of obligingness’s discursive practice; A University use an empowerment in managing to all gender, especially “transgender”. Due to a University want to open the social space to some talented get a chance for promoting to executive positions without gender border as before that they use to have abused hegemony because of different in gender and physical, Include a University develop a mentor system between seniors and junior both academic and general living as well as data publishing by Social network such as Line or Facebook to create a family climate within a University.

#### **4.2 Social reproduction in discursive practice and social practice of intrinsic reward system development in digital era of Chandrakasem Rajabhat University.**

From social practice analyze found that, intrinsic reward system in digital era of Chandrakasem Rajabhat University has efficiency since a key success factor is “empowerment” both formal and informal types. Which a University selected one faculty with best empowerment model for creating intrinsic reward to become best practice to other faculty and department, to demonstrate substantial method of decentralization system and power transfer to employees in bureaucratic structure. From this best practice can be apply and support an employees to participate in manage and decision about important work as well as routine responsibilities which all related with a management on good governance principle.

Nowadays, a competitive in education industrial has surge both a number of students down and moving employees to new organization. So, the employees retention by intrinsic reward thru empowerment process thus becoming the important factor because its make employees loyalty in long-term than other factor. Attributed to a University use learning from generation to generation under clan control to decrease an employee attrition rate in a University.

Intrinsic reward system in digital era thru empowerment process leads to successful by using a network and communication within University both from people to people and network to people, which all way have similar speed of information distribution and output but different on a width of results, In other words, when a University has a formal empowering to employees, they will use communication channel thru internal network in order to get a width of results and understanding in same direction. In turn, when the University use an informal empowering, they will have a stimulate to viral communication between people to people and group to group in order to get acceptance from each other before social acceptance.

This study of intrinsic reward system development in digital era of Chandrakasem Rajabhat University: discursive practice to social reproduction show that, text can encourage and support employees to perceive an intrinsic reward successfully in all social system and technology paradigm inasmuch as a University recognize on an important of human resource development to create valued people which clearly stated in the strategic plan of a university in several eras. Hence in digital era, a University focused on using a technology as a guide for moving forward thru empowerment both formal and informal types, consistent with the research results of Tippratum [4] found that an empowerment is a key success factor for creating employee’s intrinsic reward, due to they will have a feeling self-value and important enough to get a trust for decision making in necessary work as same as a finding from Li *et al.* [16] Meng *et al.* [17] found that the employees feel proud in power and use correctly when they received in right way, its link to increase their performance because they working under willingness that without compulsion.

From text, it’s can be clearly seen that when the employees perceived all 5-intrinsic reward including; sense of recognition, sense of responsibility, sense of competency, sense of competency and sense of obligingness which align with a research of Tippratum [4,8] Tymon, Stumpf, and Doh [9] found a same result

and suggestions state that an employees will build a mental power by themselves, without compulsion or offer monetary incentives.

Discursive practice of intrinsic reward system of a University depends on foundation of the empowerment in all types, by using social media under a University's oversight as a mechanism to publish to all context. Because, this method driving a quick acceptance, efficiency and reliability. By the way, various data and information will be screening from public relations department of a University before online published. Consistent with the research of Hill, Betts and Gardner [18] found that, digital technology serving as a tools to empowerment and people use digital technology to empower themselves and protect them from the negative effects of the digital divide, it's can be clearly seen that the empowerment is the best thing in all era, as seen from research of Wahid *et al.* [19] found that building capacity at local level is an important ingredient for sustainable development, as it not only provides local stakeholders with an opportunity to participate in decision-making, but also enables "community ownership", a key component of empowerment. Therefore, a University support the empowerment concept in work process to all level of employees in order to create substantial intrinsic reward.

## 5. Conclusions

Discourse of developing intrinsic reward system in digital era have a clear blueprint and can apply for retention employees which are a key mechanism to drive a University. All concept are depend on systematic thinking Somsri (pseudonym) [20] say that "the employees are member of our family. So, insider have to receive privilege before outsider." These things help to build enormously employee's morale. However, a retreat and intense competition in education industry decrease a number of students which is necessary problem to keeping stay in top rank of Rajabhat University as in the past, so, to stimulate an employee to have a loyalty to a University by creating intrinsic reward may not be enough because these employees should be talented who can makes a competitive advantage to a University. Therefore, in the future, a University should develop suitable intrinsic reward system with high potential successor, As mentioned;

*Somrak (pseudonym) [14] say that "all of paradigm shift of human resource management, good people are not enough, must be talented to be winner"*

## Acknowledgements

This paper are based on many research and empirical evident as well as received good cooperation from 15 key informants that working on Chandrakasem Rajabhat University. Especially, the researcher obtained encouragement from the family, friends that support to create this research paper which continue from my thesis in doctoral degree.

## References

- [1] Cropanzano R, Mitchell MS. Social exchange theory: an interdisciplinary review. *Journal of Management*. 2005; 31(6): 874-900.
- [2] Elstad E, Christophersen KA, Turmo A. Social exchange theory as an explanation of organizational citizenship behaviour among teachers. *International Journal of Leadership in Education*; 14(4): 405-421.
- [3] Orlandi LB. Organizational capabilities in the digital era: Reframing strategic orientation. *Journal of Innovation & Knowledge*. 2016; 1: 156-161.
- [4] Tippratum C. Intrinsic reward of retirees: study for grounded theory. *Proceeding The 41<sup>st</sup> National and 5th International Graduate Research Conference Valaya Alongkorn Rajabhat University under the Royal Patronahe*. 2016; 45-56.
- [5] Tippratum C. *Organizational Behavior*. Bangkok: Faculty of Management Sciences, Chandrakasem Rajabhat University; 2015.
- [6] Robertson I, Cooper C. *Well-Being; Productivity and Happiness at Work*. London: Palgrave Macmillan; 2011.
- [7] Fairclough N. *Discourse and social change*. Oxford: Polity. 1999.
- [8] Tippratum C. Factors of Intrinsic reward in Chandrakasem Rajabhat University. *Proceeding National Graduate Research Conference Eastern Asia University*. 2017; 167-168.
- [9] Tymon WG Jr, Stumpf SA, Doh JP. Exploring talent management in India: the neglected role of intrinsic rewards. *Journal of World Business*. 2010; 45(2): 109-121.
- [10] Podhisita C. *Science and art of qualitative research*. 6<sup>st</sup> ed. Bangkok: Amarin Printing & Publishing Public Co., Ltd. 2013.



- [11] Creswell JW. Qualitative research inquiry and research design: Choosing among five approach. 2<sup>nd</sup> ed. California: Sega Publication, Inc. 2007.
- [12] Somporn (pseudonym) (key informant). Tippratum C. (Interviewer). June, 20<sup>th</sup> 2017.
- [13] Sompit (pseudonym) (key informant). Tippratum C. (Interviewer). June, 24<sup>th</sup> 2017.
- [14] Somrak (pseudonym) (key informant). Tippratum C. (Interviewer). July, 2<sup>nd</sup> 2017.
- [15] Sombat (pseudonym) (key informant). Tippratum C. (Interviewer). July, 15<sup>th</sup> 2017.
- [16] Li Y. et al. Locus of control, psychological empowerment and intrinsic motivation relation to performance. *Journal of Managerial Psychology*. 2015; 30(4): 422-438.
- [17] Meng Y. et al. Supervisors' leadership and health science searchers' intrinsic motivation. *Nankai Business Review International*. 2015; 6(1): 68-81.
- [18] Hill R, Betts LR, Gardner SE. Older adults' experiences and perceptions of digital technology: (Dis) empowerment, wellbeing, and inclusion. *Computers in Human Behavior*. 2015; 48: 415-423.
- [19] Wahid A. et al. Barriers to empowerment: Assessment of community-led local development organizations in Pakistan. *Renewable and Sustainable Energy Reviews*. 2017; 74: 1361-1370.
- [20] Somsri (pseudonym) (key informant). Tippratum C. (Interviewer). July, 17<sup>th</sup> 2017.

# The Academic and Vocational Service Model of Institute Vocational Education of Bangkok in Thailand

Chantana Potikruprasert<sup>1,\*</sup>, Pariyaporn Tungkunan<sup>2</sup>  
and Siripan Choomnoom<sup>3</sup>

<sup>1</sup>PhD. Candidate, Educational Administration, Industrial Education and technology Faculty,  
King Mongkut's Institute of Technology Ladkrabang, Bangkok, Thailand

<sup>2</sup>Associated Professor, Industrial Education and technology Faculty,  
King Mongkut's Institute of Technology Ladkrabang, Bangkok, Thailand

<sup>3</sup> Retired Government Officials  
Department of Industrial Education, Faculty of Industrial Education  
King Mongkut's Institute of Technology Ladkrabang, Bangkok, Thailand, Thailand

## Abstract

The aim of this research to educate the Academic and Vocational Service Model of Institute Vocational Education of Bangkok in Thailand. The researcher used the Documentary research method. The research result were found that the Academic and Vocational Service Model of Institute Vocational Education of Bangkok in Thailand consisted of 3 parts, 1) there are six categories of academic services as following; Examination and analysis, To advise about the academic and learning, Organization of training, meeting and seminar, To set machinery and equipment, Research service, and Maintenance service. 2) The five factors of academic service learning principles as follows: The principle of trustworthiness, the principle of confidence, the principle of instant response, the principle of regard, and the principle of objectiveness. And 3) The Academic Services-Learning Procedure are as following: To survey demand of the community, To plan academic service-learning and profession, To follow the academic service- learning and profession plan, To monitor and evaluate, To develop the academic service, and To disseminate knowledge to community and public.

**Keywords:** Academic and Vocational Service Model, Academic Service, Institute Vocational Education of Bangkok

## 1. Introduction

Service learning is a teaching and learning strategy that integrates meaningful community service with instruction and reflection to enrich the learning experience, teach civic responsibility, and strengthen communities[1].

The academic service-learning is a main mission of Higher education institutions, in order to develop the community and society permanently. Institute should serve the academic to the community, society and the country in many categories. Moreover, effective institute should provide free academic service or with reasonable fee. The institute should serve both public and private sections, public and private organization, community and society. The academic service is not only useful for the society, but the institute itself gets advantages from many ways. For example, the institute can increase knowledge and experience of the lecturer,

Then they can improve course, integrate the knowledge in teaching management and research, and develop the academic position of the lecturer. In addition, the institute can create network with other organization, which can be job source of the student. The institute itself can gain income from academic service as it is specified in the vocational reform that nine elements must be reformed; 1) quality of learner, course and vocational learning, 2) image and vocational values, 3) education standard, 4) cooperation with enterprise, 5) ICT for vocational education, 6) learner increasing, 7) to produce and develop lecturer, 8) Financial system and vocational education budget, and 9) vocational education structure/ decentralization/ area based [2].

To develop the community to be strong, the government or the concerned have to seriously support learning of the community because effective learning guide the people how to solve the problem in their daily life and can develop the community continuously. Moreover, the local wisdom will be supported and the results will be extended.

---

\*Corresponding author; e-mail: 54630164@kmitl.ac.th

The policy of the Institute of Vocational Education shows that the academic service-learning is very important as it is issued in the Vocational Education Act BE 2551. However, variety and category of the academic service-learning is still not be designed. Therefore, it is very interesting to study variety and category of the academic service-learning of the Institute of Vocational Education of Bangkok in Thailand, in order to be guideline for proper management of the academic service-learning, and develop life quality of the community. Then, the people can stay on their own and live happily. Therefore the researcher interested to create the Academic and Vocational Service Model of Institute Vocational Education of Bangkok in Thailand.

## 2. Research objective

To design the Academic and Vocational Service Model of Institute Vocational Education of Bangkok in Thailand

## 3. Materials and methods

The researchers use the documentary research method followed on the theory of Scott [16] with the use of primary and secondary materials, the researchers assessed and analyze the documents ourselves before extracting content. Appraising documents typically includes four criteria: authenticity, credibility, representativeness, and meaning.

The researchers educate the Academic and Vocational Service Model of Institute Vocational Education of Bangkok in Thailand. Researchers studied 3 parts contains of the first idea was the conceptual were the ideal from academic service of the Institute of Vocational Education of Bangkok. The second was the concept about the service principles in academic service learning principles in the Institute of Vocational Education, Bangkok, and the third was The Concept about the Academic Services - Learning Procedure.

A. The conceptual were the ideal about the academic service from the universities in Thailand as follows: 1) King Mongkut's University of Technology Thonburi[3] 2) King Mongkut's Institute of Technology Ladkrabang [4] 3) Maejo University [5] 4) Rajamangala University of Technology Thanyaburi [6] 5) Kasetsart University Kamphaengsaen Campus [7] 6) King Mongkut's University of Technology North Bangkok [8] 7) The Office of Vocational Education Commission [2] and 8) Prince of Songkla University [9]. In order to find the concept about variety of academic services of the Institute of Vocational Education of Bangkok under the OVEC, there are many concepts from many Institutes were studied as the following.

1. King Mongkut's University of Technology Thonburi [4] specified concept about variety of academic service-learning in four categories.

- 1.1 Examination and analysis
- 1.2 Advice about the academic
- 1.3 Organization of training, meeting and seminar
- 1.4 To design and set up the machinery and equipment

2. King Mongkut's Institute of Technology Ladkrabang [5] specified concept about variety of academic service-learning in six categories.

- 2.1 Examination and analysis
- 2.2 Advice about the academic and researches
- 2.3 Research service
- 2.4 To design and set up the machinery and equipment
- 2.5 To design, calculate and sketch
- 2.6 Organization of training, meeting and seminar

3. Maejo University [6] specified concept about variety of academic services in three categories.

- 3.1 Making a study trip, training, discussion and workshop
- 3.2 Tools and equipment, place, educational information technology service
- 3.3 Advice about the academic, technique, profession and information

4. Rajamangala University of Technology Thanyaburi [7] has concept of creative academic service for self-employed and profession, in order to increase the competitive quality. The service consists of three categories.

- 4.1 Organization of training
- 4.2 Demonstration and practicing
- 4.3 To advise

5. The concept of academic service of Kasetsart University Kamphaengsaen Campus [8] consist of four categories.

- 5.1 Making a study trip

- 5.2 Job training
- 5.3 Training
- 5.4 Research service

6. The concept of academic service-learning of King Mongkut's University of Technology North Bangkok [9], in which there are six institutes; Institute of Technological Development for Industry (ITDI), Thai-French Innovation Institute, Institutes of Computer and Information Technology (ICIT), Thai –German Dual Education and e-learning Development Institute (TGDE), Institute of Science and Technology, and Institute of Technical Education Development (ITED), consist of six categories.

- 6.1 Training and seminar
- 6.2 Examination and Monitoring
- 6.3 Research service
- 6.4 Academic and learning service
- 6.5 Data base service
- 6.6 Location service

7. The Office of Vocational Education Commission [2] specified the concept of academic service-learning as following.

- 7.1 To advise the academic and learning
- 7.2 Training, meeting and seminar
- 7.3 To provide community welfare
- 7.4 Maintenance service
- 7.5 Development of technology and innovation

8. Prince of Songkla University [10] specified variety of the concept of academic service-learning as following.

- 8.1 Analysis, examination, monitoring and maintenance service
- 8.2 Health service
- 8.3 Organization of training, seminar and workshop
- 8.4 To study, research, analyze, and design assessment
- 8.5 To advise and suggest
- 8.6 Information and translation service
- 8.7 Other services

The concept of academic service of the Institute of Vocational Education of Bangkok in Thailand was analyzed, it can be synthesized that there are six categories of academic services, considering only the choices with frequencies of three or up, there are six academic services as following.

- 1. Examination and analysis
- 2. To advise about the academic and learning
- 3. Organization of training, meeting and seminar
- 4. To set machinery and equipment
- 5. Research service
- 6. Maintenance service.

B. The concepts of service principles from 1) Wittaya Danthamrongkun [10] 2) Jittinan Nantapaiboon [11] 3) Pisit Pipatpokakun [12], and 4) Berry, Zeithamal and Parasuraman [13]. The ideal as defined by organizations, academicians, and researchers were studied and then synthesized. considering only the choices with frequencies of three or up, there are six of service principles as following. It was concluded that there were 5 a factors of academic service learning principles in the Institute of Vocational Education, Bangkok, as follows:

- 1. The principle of trustworthiness;
- 2. The principle of confidence;
- 3. The principle of instant response;
- 4. The principle of regard, and
- 5. The principle of objectiveness.

The detail of academic service learning principles in the Institute of Vocational Education, Bangkok, as follows:

- 1. The principle of trustworthiness means the knowledge and ability of the academic and professional service providers to the recipient properly, Polite and friendly
- 2. The principle of confidence means the confidence in the academic and professional services that to provide the exact service with integrity which is respond to the needs.

3. The principle of instant response Means the readiness of the potential personnel that response for the requirement of customers in a timely manner.

4. The principle of regard means being courteous, willing to pay attention to the needs of the academic and professional service providers with consistently, benefit of the recipient.

5. The principle of objectiveness means materiality, quality of service. There are location, equipment, materials and personnel, and enables the service provider to recognize that the service provider is willing to serve.

C. The Concept about the Academic Services-Learning Procedure from many institute and researchers. There are 1) Lampang Rajabhat University [14] 2) Office of Vocational Education Commission [2], and 3) Thammasat University [15], as following:

1. Lampang Rajabhat University [14] specified the Academic Services-Learning Procedure as following.

- 1.1. To survey demand in the community
- 1.2. To plan academic service-learning and profession
- 1.3. To follow the academic service-learning and profession plan
- 1.4. To monitor and evaluate
- 1.5. To integrate academic knowledge
- 1.6. To develop the academic service
- 1.7. To disseminate knowledge
- 1.8. To conclude, evaluate success, and to report

2. Office of Vocational Education Commission [2] specified the Academic Services-Learning Procedure as following.

- 2.1. To follow the academic service-learning and profession plan
- 2.2. To disseminate knowledge
- 2.3 To appoint committees for academic service-learning
- 2.4 To hold meetings for academic service-learning frameworks of own institutes
- 2.5 To make operation handbooks for users

3. Thammasat University [15] specified the Academic Services-Learning Procedure as following.

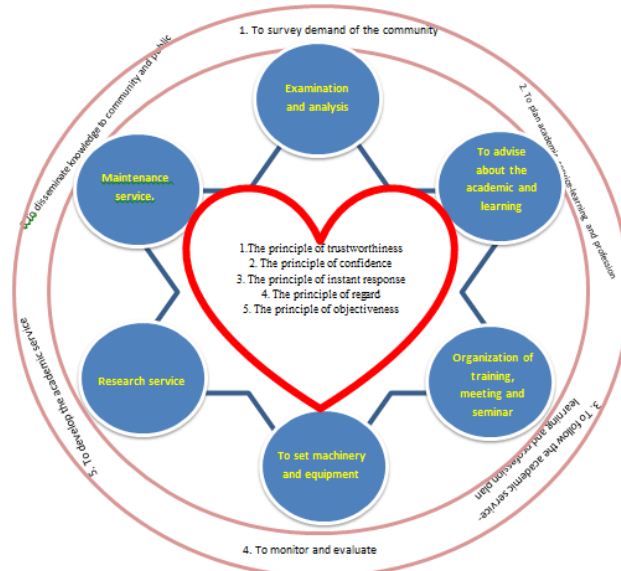
- 3.1. To survey demand in the community
- 3.2. To plan academic service-learning and profession
- 3.3. To follow the academic service-learning and profession plan
- 3.4. To monitor and evaluate
- 3.5. To develop the academic service
- 3.6 To disseminate knowledge

Considering only the choices with frequencies of three or up, there are six academic service-learning procedures, as follows:

1. To survey demand in the community;
2. To plan academic service-learning and profession;
3. To follow academic service- learning and profession planning;
4. To monitor and evaluate;
5. To develop academic service, and
6. To disseminate knowledge to the community and the public.

#### 4. Results

The result in the academic and vocational service model of institute vocational education of Bangkok in Thailand as shown in the Figure 1.



**Figure 1.** The academic and vocational service model of institute vocational education of Bangkok in Thailand

From the Figure 1 that found the academic and vocational service model of institute vocational education of Bangkok in Thailand as follow:

A. The concept of academic service of the Institute of Vocational Education of Bangkok in Thailand was analyzed, it can be synthesized that there are six categories of academic services as following.

1. Examination and analysis means systematic measurement by using scientific learning processes. This interpret classification into categories to visualize the relationships of different parts. This is tell about the amount, quantity and quality of the test or analysis.

2. To advise about the academic and learning means the process of educating people about education and careers through the use of educational media content and practice to changed idea , attitude, and behavior about the that thing.

3. Organization of training, meeting and seminar means the gathering of people for exchanged knowledge or find a solution by using Knowledge, Understanding, Skill, and Attitude of individuals to create new guidelines for work effectively.

4. To set machinery and equipment means the allocation of location, location, machinery, equipment, personnel equipment to be appropriate, safe and effective.

5. Research service means the implementation of the knowledge to undertake various research projects that can be useful to achieved the needs. This is for the public and private sectors, the community or bring the research results to the development of knowledge, skills, new projects to the community.

6. Maintenance service means treatment and rehabilitation for the device is available every time, with the most flexibility and speed.

B. The Concepts of service principles of the Institute of Vocational Education of Bangkok in Thailand as follows:.

1.The principle of trustworthiness means the knowledge and ability of the academic and professional service providers to the recipient properly , Polite and friendly

2. The principle of confidence means the confidence in the academic and professional services that to provide the exact service with integrity which is respond to the needs.

3. The principle of instant response Means the readiness of the potential personnel that response for the requirement of customers in a timely manner.

4. The principle of regard means being courteous, willing to pay attention to the needs of the academic and professional service providers with consistently, benefit of the recipient.

5. The principle of objectiveness means materiality, quality of service. There are location, equipment, materials and personnel, and enables the service provider to recognize that the service provider is willing to serve.

C. The Concept about the Academic Services-Learning Procedure of the Institute of Vocational Education of Bangkok in Thailand are as following.

1.To survey demand of the community means identify the academic and professional services to the community by setting a success indicator based on the basic needs of the community, the project is designed to benefit for the community.

2.To plan academic service-learning and profession means the implementation of a survey of the requirements of the social community to set the goals and indicators for providing services that are responsive to the capacity and readiness of the quality service.

3.To follow the academic service- learning and profession plan action follow on the plan by think about the benefit of community.

4.To monitor and evaluate means the process of controlling the collection of data at the beginning and during the provision of academic and professional services by checking the plan. Collected information for analyzing and evaluating the value of academic and professional services.

5.To develop the academic service means apply the evaluation results to improve the quality of academic and professional services in terms of personnel, facilities, materials, equipment and processes, to better serve academic and professional services for the service recipients are more satisfied.

6.To disseminate knowledge to community and public means the transfer of knowledge resulting from academic and professional services and to personnel within the organization via the public through various media, such as organizing meetings, publishing leaflets, brochures, websites and so on, to strengthen the local community and the benefit of the public.

The academic and vocational service model will be useful for institute vocational education of Bangkok in Thailand to service management for community and guideline for effective development of happy life quality and self-reliance in the community.

## 5. Conclusions and discussion

The Academic and Vocational Service Model of Institute Vocational Education of Bangkok in Thailand were comprised; The research result were found that the Academic and Vocational Service Model of Institute Vocational Education of Bangkok in Thailand consisted of 3 parts, 1) there are six categories of academic services as following; Examination and analysis, To advise about the academic and learning, Organization of training, meeting and seminar, To set machinery and equipment, Research service, and Maintenance service. 2) The five factors of academic service learning principles as follows: The principle of trustworthiness, The principle of confidence, The principle of instant response, The principle of regard, and The principle of objectiveness. and 3) The Academic Services-Learning Procedure are as following: To survey demand of the community, To plan academic service-learning and profession, To follow the academic service-learning and profession plan, To monitor and evaluate, To develop the academic service, and To disseminate knowledge to community and public. This result consistent with the research of Latib, Azlan Abdul, and others [17] that studied about Impact of a Service Learning Program to the University and the Community The findings show that SL played a significant role towards students' skills development, especially in communication, leadership and other soft skills. Apart from enhancing students' skills development, SL also helped to increase positive images of the universities and, at the same time, to show the universities' role as an agent for social change. As for society, the benefits that people could gain from SL were related to technology transfer, expertise and socio-economic improvement. This is also related with Maznah, Hj Ibrahim, and others [18 ] that stated integrating service learning in a liberal education course. Service learning is a teaching pedagogy that combines meaningful community service with academic instruction because Service learning project enriches students' experiences by involving them in community service activities and relating those experiences to their academic and personal development.

## Acknowledgements

I would like to express my sincere thanks to Assoc. Prof.Dr.Pariyaporn Tungkunan and Dr.Siripan Choomnoom for their invaluable help and constant encouragement to me. In addition, I am grateful for the special expert and others person for suggestions and all their help.

## References

- [1] Office of Civic Engagement & Service Learning . Definition of Service Learning. <http://www.uncfsu.edu/civic-engagement/service-learning/definition-of-service-learning>. Retrieved on August 19, 2017.
- [2] Office of the Vocational Education Commission. Policy and Strategy for Education Reform in Vocational Education Development. [Online] Retrieved on December 15, 2015, from [www.vec.go.th](http://www.vec.go.th). 2015.

- [3] King Mongkut's University of Technology Thonburi. Regulation of King Mongkut's University of Technology Thonburi on payment for hire and service. (No. 2) 2008.
- [4] King Mongkut's Institute of Technology Ladkrabang. Institute of Technology King Mongkut's Institute of Technology Ladkrabang With the income of the Office of Promotion and Academic Services. 2009.
- [5] Maejo University. Research Report "Education needs of the surrounding community." Academic service Of the Faculty of Agriculture, Mae Jo University " Faculty of Agriculture, Mae Jo University. 2012.
- [6] Rajamangala University of Technology Thanyaburi. Strategic Development Agenda, Rajamangala University of Technology Thanyaburi, 2014 - 2017. Policy and Strategic Plan Policy and Planning Division, Rajamangala University of Technology Thanyaburi. Retrieved on August 15, 2016.
- [7] Kasetsart University Kamphaengsaen Campus. Self Assessment Report Academic year 2014. Kasetsart University. Kamphaeng Saen Campus. 2014.
- [8] King Mongkut's University of Technology North Bangkok. Academic service Learning. [Online] Retrieved on December 15, 2015, from <https://www.kmutnb.ac.th>. 2016.
- [9] Prince of Songkla University. Academic service to the community. [Online] Retrieved on October 21, 2015, from [https:// www.psu.ac.th](https://www.psu.ac.th). 2008.
- [10] Wittaya Danthamrongkun. The Heart of Service. Bangkok : SE-EDUCATION Public Company Limited.2004.
- [11] Jittinan Nantapaiboon. Service Psychology . Bangkok : SE-EDUCATION Public Company Limited.2008.
- [12] Pisit Pipatpokakun. Service to the heart ... everyone come back. Bangkok : Thailand Productivity Institute. 2008.
- [13] Berry, Leonard L., Valarie A. Zeithamal, and A. Parasuraman. "Five Imperatives for Improving Service Quality." *Sloan Management Review*. 31. (1990) : 29 – 38.1990.
- [14] Lampang Rajabhat University Faculty of Education. Academic Services Manual. Retrieved on August 10, 2016.
- [15] Thammasat University. Academic Service Manual for Institutional Society Board of Social. [http://sras.tu.ac.th/images/phocagallery/service\\_society/manual\\_all.pdf](http://sras.tu.ac.th/images/phocagallery/service_society/manual_all.pdf) Retrieved on November 11, 2016.
- [16] Scott, J. P. (Ed.). *Documentary research*. Thousand Oaks, CA: Sage Publications. 2006.
- [17] Latib, Azlan Abdul; Amin, Nor Fadila; Saud, Muhammad Sukri; Kamin, Yusri. Impact of a Service Learning Program to the University and the Community. *Advanced Science Letters*, Volume 23, Number 1, January 2017, pp. 596-599(4) DOI: <https://doi.org/10.1166/asl.2017.7268>
- [18] Maznah, Hj Ibrahim; Adi, Irfan Che-Ani; Afian, Mohd Yusof Nor; Khaidzir, Hj Ismail. Decide and Recycle—Service Learning in Liberal Education Course. *Advanced Science Letters*, Volume 21, Number 7, July 2015, pp. 2289-2292(4)DOI: <https://doi.org/10.1166/asl.2015.6329>



## Community Welfare: Welfare with a Cultural Background

Jirachaya Jeawkok<sup>1,\*</sup>, Wanchai Dhammasaccakarn<sup>2</sup>, Kasetchai Laeheem<sup>2</sup>  
and Preedee Shoteshong<sup>3</sup>

<sup>1</sup> Human and Social Development department, Faculty of Liberal Arts, Prince of Songkla University, Hat Yai, Songkhla, Thailand 90112

<sup>2</sup> Human and Social Development department, Faculty of Liberal Arts, Prince of Songkla University, Hat Yai, Songkhla, Thailand 90112

<sup>3</sup> Political Development Council, Chaengwattana Road, Thung Song Hong, Chaengwattana Road, Laksi, Bangkok 10210

### Abstract

This qualitative study aimed to describe the phenomenon community welfare with a cultural background of fishermen on the Andaman coast in southern Thailand. The study performed through intensive interview as well as observation with both local community welfare receivers and non-receivers in total 16 key informants. The study results were analyzed, classified, encoded, interpreted and compiled to describe the data. The study found that the Community welfare is the management of a community's natural resources with the focus on culture. It guarantees that the community can dictate its own quality way of life. Community members should feel safe, with regards to their lives and properties, education, health, shelter, work and income, administration of justice, and social service. These may be in the forms of things, money, or gratitude. It concerns life from the moment of birth until death.

**Keywords:** Community Welfare, Cultural Background, Fishermen

### 1. Introduction

*"...In developing a country, one must follow certain steps. First, one must lay the foundation, which is sufficiency in having, eating, and using for the majority of the population, and by using equipment that is not costly but accurate by its principles. Having laid a firm foundation which is adequately ready and practical, one then builds the prosperity and economic status at a higher level respectively..." [1]*

The student would like to respectfully engage the royal guidance of His Majesty King Bhumibol Adulyadej as the preamble to this article, due to his Middle-Path work ethics and approach which accorded with the things that surrounded him and was truly practical. He was conscientious and always inventing new ways for development, focusing on maximum benefits for his people. He was a role model worthy of imitation for living well, in alignment with the approach of community welfare, in which everyone can live together as valued individuals, with dignity, virtues, good quality of life, and capability of self-sufficiency. Therefore, in this article, the student will explain the meaning of social welfare, the approach to community welfare management,

---

\* Corresponding author; e-mail: jk.jirachaya@gmail.com

the forms of community welfare management, the difference between community welfare and social welfare, and “exploding from within” community welfare, which was the work approach of King Bhumibol.

During the past 50 years, developmental effects—development of which is focused on economy and material sophistication—resulted in the degradation of religious beliefs, which had been a spiritual anchor and cultural origin. Relationship amongst community members which have been marked by kindness, goodwill, reliance, and dependability, has now changed from kindness giving into monetary trading. Government agencies are viewed as giving agencies, and therefore villagers must request permission for various projects from them. In addition, the effects of development have diminished the villagers’ power in managing their community’s natural resources and even in allocating their own agricultural produce. Furthermore, past development has lessened the villagers’ capability for sustainable living, for they were led to produce, sell for a lot of money, then spend in order to satisfy their demands. This has caused them to rely on external factors and to lack stability in living, because they are always restricted by outside determinants. Meanwhile, culture is what man has earned through learning, and is a process and product that will forever walk side-by-side with man. However, in utilization of culture, changes and adjustments can be made according to present times and factors, but still with the same objective; that is, to help humans live well physically, mentally, emotionally, socially, and spiritually. Thus, this equates to utilizing the fruits of knowledge, thoughts, and forms of behaviors. [2]

Thus, the student would like to actualize “explosion from within,” the work principle of King Bhumibol, by utilizing community culture—a social capital—for community welfare. If viewed only from the surface, “community welfare” is a guarantee for its members’ “live well, eat well, be happy” way of life. However, at its core veracity, underneath the “live well, eat well, be happy” theme lie the relationships of man-and-man and man-and-nature, which are characteristic of village culture. These core values enable happiness living amidst today’s social influences that storm for competition.

As explained above, the researcher is interested in studying community welfare : welfare with a cultural background on the Andaman coast in southern Thailand, which promotes community welfare in cultural, facilitates the learning process of community welfare, and exemplifies the community as a stable, prosperous and sustainable community.

## **2. Purposes**

To describe the phenomenon of community welfare with a cultural background of fishermen on the Andaman coast in southern Thailand.

## **3. Methods**

### **Key informants**

Specific selection criteria was employed to provide a group of informants who were able to address the research problem deeply which would be beneficial to the research. The respondents were knowledgeable in the subject area. There were 3 groups in total: 1) villagers and fishermen who receive community welfare 2) Community directors and community welfare providers. 3) Professional leaders and career representatives total 16 key informants.

### **Content**

This study uses the concept of community welfare. The researchers used the Community Welfare of the Community Organizations Development Institute defined community welfare as the creation of guarantee for the confidence of community members, which comprehensively included everything that gave better life to

community members, might it be in the forms of money, gratitude, support, or anything that related to life from birth till death.[3] Researchers use the Cultural Background's Khamhom, R said that welfare pluralism diversifies services according to the culture, custom, beliefs, and values of people in a community. It also gives importance to participation by all parties—individual, private, and public sectors—in servicing the society in alignment with the problems, locations, and groups. It also focuses on work integration according to the readiness and suitability of each location. For this reason, community welfare is similar to welfare pluralism. [4]

#### **Research tools**

1. Observations are participatory and not involved. The method of observation of the researcher is to determine the purpose of observation. When the researcher was on the field, observe the context of the general condition of the area and observe the social behavior associated with the research.

2. The interviews were conducted by interviewers in accordance with the researcher's questionnaire based on objectives and interviewed on the issues that occurred during observation. In-depth interviews are used for in-depth interviews. However, contextual interviews may be adapted in area.

#### **Research area**

1) Pa Khlok sub-district, Thalang district, Phuket province, 2) LaemSak sub-district, Aow Luk district Krabi province, 3) Tha Kham sub-district, Palian district, Trang province, 4) Tammalung sub-district, Mueang district, Satun province, 5) Khlong Khan sub-district, Takua Thung district, Phang Nga province, 6) KamPun sub-district, Suk Samran district, Ranong province.

#### **Data analysis**

Observation and interview were used to gain data. Data were then synthesized, content analyzed to the objectives and the conceptual framework in the study. [5]

### **4. Results and Discussion**

#### **Social Capital and Community Culture Toward “Explosion from Within”**

The humans create culture, and culture creates humans, thus the holism of humans is one with culture. Culture has the characteristic of being learned, accumulated, and passed on by humans; it is a process and product that lives alongside humans. If culture is viewed superficially, one cannot reach the true understanding of culture creation's purpose. Therefore, the use of community culture in development will help to create mutual dependency in the man-nature relationship, so that people in the community can be more dependent on inside rather than outside resources. [2]

"Explosion from within" signifies development that focuses on fortifying the people and families in the community, so that they are first ready for development, before stepping out to outside society. It is opposed to bringing development from outside society into the community and villagers, of which many communities are not ready for and cannot adjust accordingly to the changes, thus possibly leading to failures.[6] The developmental process that uses the power of culture is the society's true capital. It is development by people in the community for the community, which is regarded as sustainable development. Issues from key informants are consistent with Boonpanya, B. proposed the concept of the competition-for-resources crisis in today's world. He wrote that the crisis is due to Western social development and discourse by capitalistic sects in many countries, including Thailand. In giving prominence to material possession, competition in trade, and investment, which imply competition for resources, people are turning their backs to the "roots of culture." Many times this course of development prohibits villagers from reaching their resources. Thus, villagers create

their own discourse to protect their leverage power and capital, by their use of local knowledge, thoughts, and environment. This is the "social capital" that builds a holistic network of harmonious relations, whose accumulation over time has turned into shared empathy among people in the community. [7]

Karnjanapan, A. viewed social capital as being critical to today's social development, such as in the areas of social support, charity, opportunity distribution, and rights defense. In raising social funds, one must consider 3 basic principles: (1) Basic approach and vision of Thai welfare, (2) basic approach of autonomous private agencies in Thai society, and (3) approach for supporting autonomous private agencies in their adjustment of roles and relations in order to measure up to changes in modern structure. Social rules and regulations for rewards or compensation and mutual use of benefits are all forms of social capital, which give equal, rightful opportunities to its members in accessing resources. [8] Meanwhile, Issues from key informants 3 topics are consistent with Phrompakping, B asserted that in analyzing social capital, one must do so in tandem with cultural capital. To briefly summarize, social capital is a horizontal and vertical social relationship between individuals, institutions, and organizations, which may be in the forms of individual, group, or network. It includes values and standards that society holds onto the influence the way of life and production method of community families. [9]

In conclusion, community culture can explain the relationships between people in the community, and may be an important factor in encouraging members to collaborate in team work and in reviving community unity, for it is a product created and passed down by the community.

#### **Social Capital and Management of Community Welfare**

At the present, in both rural and urban communities, various organizations and groups have been set up, either under government policy or community-established groups, in order to support and sustain their communities [10]. Social capital is included in these networks of organizations, along with standards, values, and mutual understanding in order to effect collaboration in the group and between groups. Meanwhile, Issues from key informants (2017). Groups that are strong will increase their roles to the development of the society; these groups have rules that specify the management of welfare for their members, or the management of activities within the community that benefit the common good. Issues from key informants are consistent with Boonyaratanasunthorn, J. presented an approach to managing community welfare which can be carried out in community development activities with differing details for each community, and can be summarized into 3 points: 1) The manner of fund raising for use in the creation and improvement of work for members of the community by mutual fund accumulation; 2) the manner of development by relying on the community's capability for unity in carrying out economic activities in order to reduce outside exploitation; 3) the manner in establishing an organization that gives support or capital for running activities that resolve community issues completely. The purpose of such establishment is to help those who face hardship as its first step, then after receiving profits, the revenue can be used to manage community welfare, such as medical units to alleviate disaster victims, handicapped individuals, and impoverished elders and children.[11] Furthermore, Organization for economic cooperation and development (2001) additionally announced that social capital will be created at the levels of family, community, company, institution, or agency at the national and regional levels. In general, the approach to social capital relates to the approach to society and population. However, the connection between "trust" and "network" is dependent upon public institutions and organizations.[12]

Moreover, Poshnukul, S. P. studied welfare on the foundation of culture. It derives from the concept of giving value and importance to community culture, and the clash between government, market, and community, in that outside dependency has been dominated by capitalism and the government. In this matter, a community's indicator of strength is its capability to retain its unique characteristics and determine its own direction. Community is still free to determine its production in order to satisfy the demands of its families and community; and community can still preserve its values system and cultural foundation. In fact, most studies explain that changes in a community's way of life correlate with changes in the economy, especially the production system. Thus, changes in rural areas are clearly evident.[12] Issues from key informants (2017) The concepts of community culture, social capital, and fortification of local communities can help the student to understand and explain the development of community welfare under the framework of community culture. It helps the student to see dimensions of self-sustainability in communities.

The results of community welfare management are the blossoming of good relations between members of the community, mutual support, feelings of confidence, pride, honor, and happiness, both physically and mentally. Additionally, Wetyachai, A. and Yodkamolsart, S. formulated the management of community welfare. Important aspects of managing welfare of a cultural basis are to support religious places is an important source of welfare since times past. For example, in Buddhist communities, the disadvantaged would ordain in order to receive education from temples. Some were ordained in order to receive food to feed their families.[13] In Muslim communities, charity giving of zakat is a support system according to Islamic principles, which believe that all Muslims with income have the duty to aid the disadvantaged by giving 2.5% of their annual income. Receivers of zakat fall into 8 categories, such as those without possession or tools to make a living, those without tools to earn a living which will adequately satisfy standard needs, those who have freed themselves from slavery, those who need support for continuing education, those with debts, and those who face difficulties while traveling.

### **Community Welfare: Welfare Based on Culture**

Community welfare is the building of guarantee, so that its members may be confident in matters of education, health, dwelling, work, income, recreation, justice process, and social service. It betters everyone in the community, and may come in the forms of things, money, kindness, or help. It intertwines with its members' way of life from birth till death. Community welfare is a social act; therefore, it needs the collaboration and learning of people in the community. It gives the people maturity of wisdom, good relationships, and feelings of pride, eligibility, honor, and happiness, or what they say, "Live well. Eat well. Be happy." It is regarded as development with culture as its basis. It focuses on building strength for the people and families in its community, by first making them ready to receive development, or "to explode from within," which is King Bhumibol Adulyadej's work approach.

However, this synthesis considers monetary welfare as monetary support for "buying" outside welfare, so that its members may be guaranteed "access" to the welfare produced by the government and market (for example, education and medical care), not welfare produced by the community itself. On the other hand, for welfare based on the foundations of culture and resource, the community itself is the producer of welfare, such as the production and exchange of food, medicine, clothing, and danger protection. Modern community welfare which creates some sort of guarantee by the community itself is an endeavor that should be encouraged

(especially when it results in social and mental development). Moreover, the author is of view that each community should be able to see its role as being more than simply providing welfare through other monetary organizations, because in actuality, each community is capable of welfare provisions in many ways, as follows.

(1) Creation of guarantee or financial service for its members to gain access to welfare provided by the government and market (as is done by many groups at the present).

(2) Production of welfare by the community for the community. Due to the limited budget of each community, production of welfare should be chosen according to its effects on the community's identity, way of thinking, and culture (because the government cannot do this better). It is a welfare production that utilizes local wisdom, workforce, and resources.

(3) Creation of a community network to push forward policies in order for the government and market to produce quality welfare which better aligns with the needs of communities.

The creation of networks can reflect the relationships and agglomeration of the people in the forms of network groups with various interconnecting ties, in which members of the networks generally exhibit similar characteristics, such as inclinations for the same types of sports or occupations. This also includes groups of relatives and friends (Issues from key informants, 2017). From the explanation in the work of Norat, C. it can be seen that the management of community welfare relates to and is important to the local economy. He categorized types of community welfare in line with the categories of social welfare; that is, community welfare is composed of:[14]

Community service means welfare in order to prepare for and manage the community economy, such as ways of living, eating, and using, as well as physical and mental health, by collaboration of similar strong members.

Community insurance means welfare from the process of distribution and consumption of the community economy, such as family insurance, community insurance, and environmental insurance, in which stronger members temporarily manage for weaker members.

Community charity means welfare from the process of distribution and consumption of the community economy (gratuitous), such as merit festival and sharing, in which stronger members or laypeople organize for weaker members or the ordained. It is noteworthy that Norat, C's categorization considers the relationship between the giver and receiver, in a way that relies on and is dependent on one another.

## 5. Conclusions

Community welfare is a social act, thus it entails cooperation and education of people in the community, so that the community may have cognitive maturity, mutual understanding, and feelings of stability and confidence, and may live eligibly, honorably, and happily.

Cultural Background In the article, fishermen's community culture is characterized by its holism and dynamics. Each dimension and component of culture interconnects itself and with the external system, until they cannot be differentiated. The fishermen dynamically move and adjust according to the context and time.

## Recommendations

### 1. Policy Recommendations to Apply Research Results in Practice

The implementation of community activities regarding community welfare should be in-depth and clear. The activities should encourage people in the community to be able to identify problems, find solutions and prevent problems themselves. This will help raise community awareness of building a strong community. State organization should promote self-driven communities rather than communities which are always dependent on state's assistance.

### 2. Suggestions for Future Research

This study describes the phenomenon of community welfare with a cultural background of fishermen on the Andaman coast in southern Thailand. Future research may be done in one provinces to describe in the cultural background depth to community depth of the province. It is also recommended to study the development and implementation of community welfare systems among fishermen.

## Acknowledgements

An article in partial fulfillment of the thesis: The process of driving community welfare by fishermen on the Andaman coast of southern Thailand. Funded by the Office of the Higher Education Commission, Faculty of Liberal Arts and Graduate School, Prince of Songkla University.

## References

- [1] Royal Guidance in the Commencement Ceremony of Kasetsart University at the University Auditorium on July 18, 1974. Retrieved on August 9, 2016, from <http://www.sa.ku.ac.th/king-spku/2517-1.htm>
- [2] Jeawkok, J., Yammai, S. & Sangharat, U. Norah and Health of People and Their Community. Thai Case Study Journal. 2016, 13 (1); 150-176.
- [3] Community Organizations Development Institute. Handbook for the Actuation of Community Welfare Support Project. Bangkok in Thailand: Appa Printing Group. 2009.
- [4] Khamhom, R. Community Welfare and Thai Society. 4<sup>th</sup> ed., amended. Bangkok in Thailand: Thammasat University Printing Press. 2014.
- [5] Phothisa, C. The science and art of qualitative research. 2<sup>nd</sup> ed. Bangkok in Thailand: Aammarin printing. 2006.
- [6] Office of the National Economics and Social Development Board. Learning from the Work Approach of the King.; 2008 [cited 9 August 2016]. Available from: [http://www.nesdb.go.th/download/article/article\\_20150728110135.pdf](http://www.nesdb.go.th/download/article/article_20150728110135.pdf)
- [7] Boonpanya, B. Three Decades of Community Culture Approaches. Bangkok in Thailand: October Printing Press. 2001.
- [8] Karnjanapan, A. Social Capital and Community Rights in the Community's Viewpoint: Local Thoughts on Rights, Power, and Resource Management. Bangkok in Thailand: Thailand Research Fund. 2001.
- [9] Phrompakping, B. Report of Research, Formation, Re-Production, and Expansion of Social Capital in Rural Northeastern Thailand. Bangkok in Thailand: Thailand Research Fund. 2004.
- [10] Rojpaisarnkij, K. Development of Integration Methods of Community Welfare Funds Network at the District Level, Chachoengsao Province. Rajabhat Rajanagarindra University. 2007.

- [11] Boonyaratanasunthorn, J. Community welfare: Approaches and Methods for Knowledge Creation and Development of Thai Society. Thammasat University. 2004.
- [12] Organization for Economic Cooperation and Development. The Well-being of Nations: The Role of Human and Social Capital. Paris: Organization for Economic Cooperation and Development. 2001.
- [12] Poshnukul, S. P. Literature Criticism and Knowledge Synthesis of Community Welfare in Thailand. Bangkok in Thailand: Insitution of Knowledge Development for Community Happiness. 2009.
- [13] Wetyachai, A. & Yodkamolsart, S. Social Welfare the Villager Version. Economics and Politics Study Center, Faculty of Economics, Chulalongkorn University. 2003.
- [14] Norat, C. Thai Rural Community Welfare. Doctoral dissertation, Faculty of Social Administration. Bangkok in Thailand: Thammasat University. 2003.

### Individual Interviews

- Ann who respondents. Jeawkok, J. who interview, Tha Klang community, Moo 4, KamPun sub-district, Suk Samran district, Ranong province, Thailand. On February 15, 2017.
- BandMad who respondents. Jeawkok Jirachaya who interview, Pa Khlok sub-district, Thalang district, Phuket province, Thailand. On February 6, 2017.
- BangDum who respondents. Jeawkok Jirachaya who interview, Pa Khlok sub-district, Thalang district, Phuket province, Thailand. On February 6, 2017.
- BangLae who respondents. Jeawkok Jirachaya who interview, Khlong Khan sub-district, Takua Thung district, Phang Nga province, Thailand. On February 12, 2017.
- BangLao who respondents. Jeawkok Jirachaya who interview, Pa Khlok sub-district, Thalang district, Phuket province, Thailand. On February 6, 2017.
- Bangmad Leamsak who respondents. Jeawkok Jirachaya who interview, Ao Nam community, Leamsak sub-district, Ao Luek district, Krabi province, Thailand. On February 9, 2017.
- BangMee who respondents. Jeawkok Jirachaya who interview, Moo 1, Tha Kham sub-district, Palian district, Trang province, Thailand. On February 7, 2017.
- Bung Chad who respondents. Jeawkok, J. who interview, Tha Klang community, Moo 4, KamPun sub-district, Suk Samran district, Ranong province, Thailand. On February 15, 2017.
- Bung Chai who respondents. Jeawkok, J. who interview, Tha Klang community, Moo 4, KamPun sub-district, Suk Samran district, Ranong province, Thailand. On February 15, 2017.
- KaCha who respondents. Jeawkok, J. who interview, Tha Klang community, Moo 2, Tammalung sub-district, Mueang district, Satun province, Thailand. On February 5, 2017.
- KoSee who respondents. Jeawkok Jirachaya who interview, Khlong Khan sub-district, Takua Thung district, Phang Nga province, Thailand. On February 12, 2017.
- Muaenjai who respondents. Jeawkok, J. who interview, Tha Klang community, Moo 1, Tha Kham sub-district, Palian district, Trang province, Thailand. On February 7, 2017.
- PeeDew who respondents. Jeawkok Jirachaya who interview, Moo 2, Tha Kham sub-district, Palian district, Trang province, Thailand. On February 7, 2017.
- Peeya Aoboto who respondents. Jeawkok Jirachaya who interview, Ao Nam community, Leamsak sub-district, Ao Luek district, Krabi province, Thailand. On February 9, 2017.
- To-ei-mum who respondents. Jeawkok Jirachaya who interview, Moo 3, Tammalung sub-district, Mueang district, Satun province, Thailand. On February 5, 2017.
- WaDin who respondents. Jeawkok Jirachaya who interview, Ao Nam community, Leamsak sub-district, Ao Luek district, Krabi province, Thailand. On February 9, 2017.



# An Exploration of Science Student Teachers' Understanding of STEM Approach and Teaching Practices During Professional Teaching Practices

Pinthudit Klinkajorn<sup>1</sup>, Mattanee Siengsanoh<sup>4</sup> and Kittipong Siengsanoh<sup>2,3,\*</sup>

<sup>1</sup>College of Industrial Technology, King's Mongkut University of Technology North Bangkok, Thailand

<sup>2</sup>Physics Program, Faculty of Science and Technology, Nakhon Pathom Rajabhat University, Nakhon Pathom, 73000, Thailand

<sup>3</sup>Center of Excellence in Glass Technology and Materials Science (CEGM), Nakhon Pathom Rajabhat University, Nakhon Pathom, 73000, Thailand

<sup>4</sup>Science Program, Wathuaichorakha Witthayakhom School, Nakhon Pathom, 73000, Thailand

## Abstract

This study explored what science student teachers understood about STEM education and teaching practices in their field during professional teaching practices. The participants were science student teachers at a public university who were enrolled in professional teaching practices at a primary school level. Data were collected by classroom observation, field note, semi-structured interview and analysis of lesson plan documents were triangulated. Inductive process was used to analyze the data. The result indicated that the science student teachers had inadequate understanding of the STEM education approach because they lack of knowledge about the principles, process and how to do STEM and most of science student teachers were usually use lecture based in their classroom. This article offers suggestions that there should be a good plan for developing method of instruction to promote understanding and teaching practices of STEM education approach

**Keywords:** STEM education, science teaching practices, science student teachers

## 1. Introduction

At present, the world is developing in technology. Many science educator are focusing on the ways to improve the preparation of students to increase attention in science, technology, and innovation as well as become more knowledge-intensive in the field of Science, Technology, Engineering and Mathematics (STEM) at the all levels of education. STEM is an education approach which focuses on innovation and it is applicable for all education levels [1]. STEM education not just knowledge but includes several skills. STEM education has been known as the preparation of students in competencies and skills in science, technology, engineering, and mathematics. The success of STEM education will provide students to integrate with science, mathematics, and engineering to use in real-world applications [2]. Many science educators have suggested that STEM education is a standard-based at all school levels where all science teachers, especially science, technology, engineering, and mathematics (STEM) teachers can integrate this approach to teaching and learning [3]. STEM were believed that can help students become interested in STEM career and build a nation's STEM-educated workforce that can be used to meet the demands of industry and business in a complex and technology-driven economy [4]. By STEM approach, it is aimed to educate people who can associate with sciebee, technology, engineering and mathematics fields.

Teaching STEM necessary to make students to understand issue or problem and be able to solve problem in real life. STEM education can provide critical thinking, creating science literate person (as a goal of science education) and can become an innovators that leads to new products and processes that benefit for national economy. This innovation and science literacy depends on a strong content knowledge base in the STEM areas and in the future, most jobs will require a basic understanding of math and science [2].

[5] described process of using local community and environment as a context to teach concepts in subjects across the curriculum in a way to emphasizes hands-on and real-world learning experiences. According with [6] identified experience-based instruction that occurs in the natural environment as a productive pedagogy, providing engaging and enduring learning. STEM is incorporate inquiry activities which enable students to pose the questions and investigate problems based on real world contexts. STEM education has played an important role to improve 21st century skills in every aspect of life. STEM is an education reform [7], it is important that the teacher and science student teachers who are the practitioners of reform movements in science education are trained in STEM education.

The new science student teacher education program provides more opportunity to engage their knowledge and experience for teaching. In Thailand experience course begin in second year of study and

---

\* Corresponding author; e-mail: kittipongpat@webmail.npru.ac.th

continue through the final year of study. The aim of the program to develop the pedagogical content knowledge and apply their knowledge into real situation in classrooms.

Scientific concepts should be taught to reflect the acquisition of science knowledge and scientific concepts at the heart of science, especially in physics, which is a branch of science. In physics, all of students are learned algebra-based with emphasis on development of conceptual standing to solve the problem. Science student teachers need to undergo profound change in their views about the goals and methods for teaching. STEM requires new approaches for engaging students and to maintain the connection between students and the surrounding world.

## **2. Science, Technology, Engineering and Mathematics**

STEM education is an idea of teaching science that focuses on issues related to science and mathematics to lead in the application of engineering and technology [8]. The aim of STEM is motivated students and increase interesting in science and mathematics and increase the number of students to advanced degrees and careers in STEM fields. STEM education has provided students to integrate with science, math, and engineering in contexts that make connection into their work in their daily lives [9]. The components of STEM consist of; 1. Science is a subject that studies about natural phenomena through the process of scientific inquiry 2. Technology is a study about to solving problems, improving and developing things to meet the demands and needs of human beings. 3. Engineering is related with innovation or invention to facilitate human being by using mathematical and scientific knowledge with technological processes. 4. Mathematics is the subject that related with calculation. It deals with principles and reasons. It makes the process of thinking and calculation skills.

STEM activities based on interdisciplinary approaches that will make learning more enjoyable and easier for science student teachers were taken to their classrooms [10].

## **3. Problems statement**

The problem sentence of this research is “What is the understanding of science student teachers about STEM education practices?”

## **4. The Context of the Study**

The participants were science student teachers at a public university in Thailand who were practicing their teaching at the primary school level.

## **5. Objectives**

The objectives of this research are

1. To explore science student teachers in physics classroom including lesson planning, teaching strategies, and instruction media.
2. To study the science student teachers’ understandings about STEM education in classroom.

## **6. Methodology**

The study has been designed to use qualitative research methods.

### **6.1 Participants**

The participants in this qualitative study included 20 science student teachers, half of them are men, enrolled in the professional teaching practices science in the 2016 school year semester. The researcher finds out the science student teachers’ understanding of STEM and their teaching practices.

### **6.2 Data Collection**

In this research, the data related to the understandings of science student teachers about STEM education, the science student teachers’ understandings on STEM education were obtained from semi-structured interviews in focus group.

To obtain in depth investigation in science student teachers understands of STEM, several data collection methods and source were adopted in the study; classroom observation, field note, and semi-structured interview were adopted as a methodology.

In order to understand science student teachers’ understanding of STEM focus group were conducted. Focus group was semi-structured in that researcher asked open-ended questions and follow-up the questions based on each science student teachers’ responses. Semi-structured questions were developed by the researcher and then validated by science educators who were the lecturers in the classroom research course.

Focus group spent 30 minutes to 1 hour discussing as follows:

- 1) What ideas or teaching approaches they will take into their classroom?
- 2) What views of STEM?
- 3) Would you like to apply STEM education in your classroom as a teacher?
- 4) What are the limitations of STEM education?

The researcher collected the lesson plans and observed each science student teachers teaching in school for one time per student to observe their teaching practices. Each class was taught for 2 hours. The video recording was employed during the course. After the classroom observation, semi-structured interview was conducted to get information about STEM. The interviews were audiotaped and transcribed. The video recording was employed during the course.

In order to study teaching practices, during of the course, when the author observed each participant field notes were used to record the science student teachers teaching, behavior of science student teachers and learning behavior of students in their classroom.

To obtain in depth investigation in science student teachers understands of STEM, several data collection methods and source were adopted in the study; classroom observation, field note, and semi-structured interview were adopted as a methodology.

## 7. Data Analysis

Inductive process was used to analyze the data. The data from classroom observations, semi-structured interviews and field notes were analyses. The participant understands and opinions of STEM were interpreted. Data analysis began immediately upon receiving information from classroom observations and interviews. Interview transcripts were read by researcher and was colour highlighted in the body of the texts, sentence and passages for each participant response to determine the themes and finally the quotes from the science student teachers' response were presented to support the themes.

## 8. Results and Discussion

From classroom observations, more of participants taught by lectures, explained and let students to do the exercises. Sometimes they talked about the importance of the content to be taught prior teaches the lesson and they raised a question before teaching content followed by explanation to students. From classroom observation, participants did not address any STEM aspect in their instruction. They often talked about the content that linked to the any event in daily life, they talked about the future that related with new technology and how to use in their work, but only a few. They didn't link to the STEM to their teaching. From semi-structured interviews, participants have a good attitude about STEM. Lesson plan showed STEM lessons is not appeared in their lesson plan in other words they don't link between current issue or link to local environment in their classroom practices.

From classroom observations. I found some of science student teachers have a problem to manage their classroom example with student do not intend their teaching. They might be facing problems with students with all the abilities (fast learners or slow learners) and they concerning about lesson but do not selecting appropriate teaching approaches to deliver this knowledge to their students.

From group discussion, they described teaching practices in their classroom and reflected on their teaching they understood and retained a good information from other science student teachers. Some of participant indicate that the basic rationale for STEM education is to prepare students for real life problems or issues.

Some examples from the opinions of science student teachers in question Would you like to apply STEM education into your classroom as a teacher? Some of participants indicated that He don't want to apply because he is think it is not necessary and the one of opinion is I would like to apply because it is the best way to get students attend classes and understand relation with knowledge and real world issues.

Some examples from the opinions of science student teachers in question What are the limitations of STEM education? He said that "I think STEM education is very interesting but have time consuming I fear that I can't teach all of lesson on time in my classroom."

The results indicated that lecturers did not address the STEM in their teaching or instruction. They did not able to apply the characteristics of STEM integrate in during instruction but they expressed a good attitude about STEM approach and they felt STEM is challenging to them.

The effective STEM teachers could be understood about STEM, by focusing on a current issue to created suitable classroom environment and brought the issue or problem into their classroom and motivated students to put in the extensive effort. The important things that teachers should lead their students to meet the goal of STEM classroom.

This research finding indicates that participants had to learn pedagogies for place STEM in their classroom practices, from the research results, the researcher suggest future research to investigate how to promote the STEM in science classroom.

## 9. Conclusion

In this article, science student teachers also indicated that the basic reason of STEM education is to prepare students for real life. Some of science student teachers indicated STEM is fun, interest and help students to attend in science classrooms.

This article offer suggestions that there should be a good plan for developing and implementing STEM in university for a good understanding to science student teachers. To implement STEM education into Thai classroom will need to train STEM to science student teachers on how to planning, teaching strategies, and instruction media to teach accordance with STEM. In order to prepare science student teachers to engage their teaching practices, the suggestion that teacher education course support and encourage science student teachers to improve their teaching practices in real and complex situations [11].

## References

- [1] Gonzalez HB, Kuenzi JJ. **Science, Technology, Engineering and Mathematics (STEM) education : A primer**. Congressional Research Service, CRS Report for Congress Prepared for Members and Committees of Congress; 2012.
- [2] Francie E. **Why STEM education is important**. 2010.
- [3] Chris Merrill's Gran. **Current Perceptions of STEM Education in Illinois**. 2009.
- [4] Edward MR. **Implementing Science, Technology, Mathematics, and Engineering (STEM) Education in Thailand and in ASEAN**. STEM education workshop, 7-8 May 2013. Bangkok.; 2013.
- [5] Sobel D. **Place-based education: Connecting classrooms & communities (3<sup>rd</sup> ed.)**. Great Barrington, MA: The Orion Society; 2004.
- [6] Ballantyne R, Packer J. Introducing a fifth pedagogy: Experience-based strategies for facilitating learning in natural environments. **Environmental Education Research**. 2009; **15**(2): 243-262.
- [7] Bybee RW. **The case for STEM education: challengers and opportunities**. Virginia: NSTA Press. 2013; 116.
- [8] Morrison J. **TIES STEM education monograph series, attributes of STEM education**. 2006.
- [9] Kuenzi JJ. Science, Technology, Engineering, and Mathematics (STEM) Education: Background, Federal Policy, and Legislative Action. **Congressional Research Service Reports**. 2008.
- [10] Ibrahim E, Ayse C. Investigating the views of Pre-service Science Teachers on STEM Education Practices. **International journal of environmental & science education**. 2017; B(5): 1055-1065.
- [11] Appleton K, Kindt I. Beginnig elementary teachers, development as teachers of science. **Journal o Science Teacher Education**. 2002; **13**: 43-61.

# Factors Affecting Work Efficiency of Employees of Nong Pho Ratchaburi Dairy Co-operative Limited (Under the Royal Patronage)

Phuthai Saengchan<sup>1</sup>, Darin Photangtham<sup>1,\*</sup> and Wisit Rittiboonchai<sup>1</sup>

<sup>1</sup>Faculty of Management Science, Nakorn Pathom Rajabhat University

## Abstract

The purposes of this research study were 1) to study the levels of work efficiency of the employees of Nong Pho Ratchaburi Dairy Co-operative Limited (Under the Royal Patronage), 2) to examine the differences of personal factors and Performance Management Components that affected work efficiency of the employees of Nong Pho Ratchaburi Dairy Co-operative Limited (Under the Royal Patronage), and 3) to investigate the Performance Management Components affecting work efficiency of the employees of Nong Pho Ratchaburi Dairy Co-operative Limited (Under the Royal Patronage). 282 samples of the study were selected from the employees of Nong Pho Ratchaburi Dairy Co-operative Limited (Under the Royal Patronage) through stratified random sampling, using statistical methods including percentage, mean, standard deviation, t-test, variance, and Multi-step regression analysis. The research found that: 1) The overall work efficiency was found at a high level. When considering each aspect, the work efficiency was considered a high level in all aspects; (1) Financial (Mean = 4.10, SD = 0.65), (2) Internal process (Mean = 3.63, SD = 1.08), (3) Customers (Mean = 3.62, SD = 1.03), and (4) Learning (Mean = 3.42, SD = 1.18), respectively. 2) There were differences in work efficiency of the employees of Nong Pho Ratchaburi Dairy Co-operative Limited (Under the Royal Patronage) with statistical significance in terms of personal factors, including status, work experiences, and educational level. 3) Work efficiency of the employees of Nong Pho Ratchaburi Dairy Co-operative Limited (Under the Royal Patronage) was resulted from the factors of safety in workplace ( $\beta = 0.24$ ), admiration and acceptance ( $\beta = 0.23$ ), training development ( $\beta = 0.22$ ), and policy and administration ( $\beta = 0.23$ ). These equations had the predictive power of 0.69.

**Keywords:** work efficiency, co-operative, Performance Management Components

## 1. Introduction

Nong Pho Ratchaburi Dairy Co-operative Limited (Under the Royal Patronage) is a state-owned enterprise engaged in the dairy processing business. Over the past years, the co-operative exhibited the capacity to compete with other dairy processing companies throughout the country. Historically, the co-operative was conceived amidst the situation of oversupply of raw milk in Nong Pho area of Ratchaburi Province causing a serious problem of product distribution among dairy farmers due to the absence of factories capable for processing raw milk into dairy products. To alleviate such problem, the agricultural association in Nong Pho Sub-district decided to make a petition to His Majesty King Bhumibol Adulyadej, hoping that would help solving the problem. When the petition was accepted, His Majesty the King graciously gave an order to set up a committee panel to supervise the construction of the factory. A certain amount of the royal fund was also granted, along with the money from the people who wished to support the royal project. Since then, the business has been operated as co-operative under the intention and guidance of His Majesty the late King. Nong Pho Ratchaburi Dairy Co-operative Limited (Under the Royal Patronage) has served as the factory producing Pasteurized milk, UHT milk, and other products distributed throughout the country, with the manufacturing capacity that is sufficient for the quantity of raw milk delivered by dairy farmers in Nong Pho and its vicinity. The project effectively relieved the problem of distribution channel of raw milk. Operated in the form of co-operative, the members were the ones who benefited.

The operation of the co-operative gradually became more stable, with an increasing number of members. However, with the ever-changing market competition and the economic volatility of Thailand, the employees of the co-operative are currently lacking the motivation to perform their tasks. That inevitably led to the inefficiency of the operation and the declining competitiveness of Nong Pho Ratchaburi Dairy Co-operative

\* Corresponding author; e-mail: darin@webmail.npru.ac.th

Limited (Under the Royal Patronage). It is, therefore, crucial to examine the efficiency and responsiveness to the roles of the employees. [1]. The research study entitled “Factors Affecting Performance of Employees of Nong Pho Ratchaburi Dairy Co-operative Limited (Under the Royal Patronage) was aimed at measuring the levels of efficiency performed by the employees of the co-operative and at comparing the differences of personal factors as well as management characteristics that affected the performance of the employees. It is expected that this research will help the executives to understand the needs in terms of motivational factors that can maximize the efficiency of the employees in all departments of the co-operative. When the employees’ needs in terms of motivational factors are addressed, the employees will naturally develop a sense of satisfaction and belonging to the co-operative, and will be willing to dedicate their efforts to perform their roles. This will result in increased performance efficiency and the attainment of the targeted objectives.

## 2. Objectives

2.1. To examine the levels of work efficiency of the employees of Nong Pho Ratchaburi Dairy Co-operative Limited (Under the Royal Patronage)

2.2. To compare the differences of personal factors that affect work efficiency of the employees of Nong Pho Ratchaburi Dairy Co-operative Limited (Under the Royal Patronage)

2.3. To examine the performance management components affecting work efficiency of the employees of Nong Pho Ratchaburi Dairy Co-operative Limited (Under the Royal Patronage)

## Research Hypotheses

From the literature review, the following hypotheses can be formulated.

H1. Work efficiency of the employees of Nong Pho Ratchaburi Dairy Co-operative Limited (Under the Royal Patronage) varies according to personal factors.

H2. Performance Management Components have an influence on work efficiency of the employees of Nong Pho Ratchaburi Dairy Co-operative Limited (Under the Royal Patronage).

## Literature Review

The researchers have examined the related research studies and designed a framework for this research. The essential aspects of the literature review can be summarized as follows.

### 1. The Concept of Work Efficiency

Somjai Laksana [2]. defined work efficiency of individuals as the completion of the assigned tasks without wasting the time and energy; the performance should be fast and efficient. The staff or personnel with work efficiency are those who are determined to deliver their best performance through effective strategies or techniques that produce maximum outcomes, which are satisfactory in terms of quality and consume minimum costs, energy, and time. Priyaphorn Winganuttraroj [3] suggested that effective team or groups of employees should develop positive feelings among the members. Importantly, the supervisors should realize that most of the problems are caused by work environment and interpersonal relationships. Therefore, the effective teams require crucial conditions, which include 1) responsibility and a sense of belonging to the organization in 3 dimensions: 1. a strong passion to maintain the membership of the organization, 2. a strong determination and willingness to use their efforts for the benefits of the organization, and 3. a faith and acceptance of values and goals of the organization. 2) There is a need to develop an understanding of interpersonal relationships because when individuals feel that they are important and valuable assets, they tend to exchange creative ideas leading to progress of the organization. 3) There is a need to develop skills and competency of the members as well as techniques of working with other members. 4) It is important that the teams are equipped with facilities and are provided with third-party consultants, who collect essential information necessary for improving the performance, giving feedbacks, solving problems, and negotiating conflicts.

From the concepts reviewed, it can be concluded that efficiency refers to a crucial evaluation process of the internal systems of an agency as well as various policies. The evaluation is to identify whether or not the performances and resources are utilized in accordance with the guidelines set out. If the organization operates by the guidelines, consumes less time than expected, and utilizes fewer resources, that organization, to a certain extent, displays the work efficiency. If failed to meet the criteria, that organization reflects the lack of work efficiency.

## 2. The concept of modern management strategies

The researchers focused on applying “Balanced Scorecard” theory, which began in 1990 when Robert S. Kaplan and David P. Norton developed a new approach to measuring balanced organizational performances. Their theory was later published in the United States in 1992 and was embraced by large organizations with complexity of business operation facing with “Chaos Situation” that needed to be solved. Management and evaluation of the operations, therefore, had to take several dimensions into account [4]

Kaplan and Norton [5] stated that BSC was a tool devised for evaluating the operational outcomes and for translating strategies into action, based on the evaluation consistent with the organization and the emphasis on the success of the organization. Pasu Decharin [4] explained that BSC was both an instrument in measurement and evaluation and a management tool that transmutes strategies into action. The Civil Service Commission highlighted the meaning of “Balanced” as the balance of views necessary for organization consideration, which was required for determining Key Success Factors (KSF) and Key Performance Indicators. The aim was to prevent deviation and to allow a complete consideration of the organization from all perspectives to happen, which contributed to the “achievement report of the organization presented in the executive report facilitating the executives to track the progress of the attainment of organizational objectives.” Alongkorn Meesuttha and Smit Satchukorn [6] stated that BSC was multi-dimensional structure used to determine the directions, to implement, and to manage all levels strategically. It was done through the linkage of program objectives, projects or activities, and assessment/evaluation with the organizational strategies.

Kaplan and Norton [5] described the four components of the BSC developed as a tool for organizational evaluation. Those 4 components or perspectives were:

1. Financial Perspective is indicative of outcomes and financial status of the company. Importantly, it reflects the expectations of shareholders or owners in terms of profits or dividends.

2. Customer Perspective is the perspective in which the organization or company must focus on the strategies towards customers’ satisfaction and positive image of the organization.

3. Internal Process Perspective is the view that the organization must focus on delivering the results in various aspects related to the production process, service process, and especially the processes in organizational units as an important strategy leading to customer satisfaction.

4. Learning and Growth Perspective is the perspective in which the organization will be able to have results in production process or excellent services. This demands capable, competent, and creative personnel who are willing to learn and research for new products. Learning and Growth Perspective is, therefore, a crucial foundation of long-term and sustainable success of the organization.

Therefore, the definition of BSC can be summarized as a tool used to evaluate the performance or operation, with different perspectives beyond finance. BSC is also a tool required for the translation of strategies into action to attain organizational objectives and ultimately for creating learning organizations.

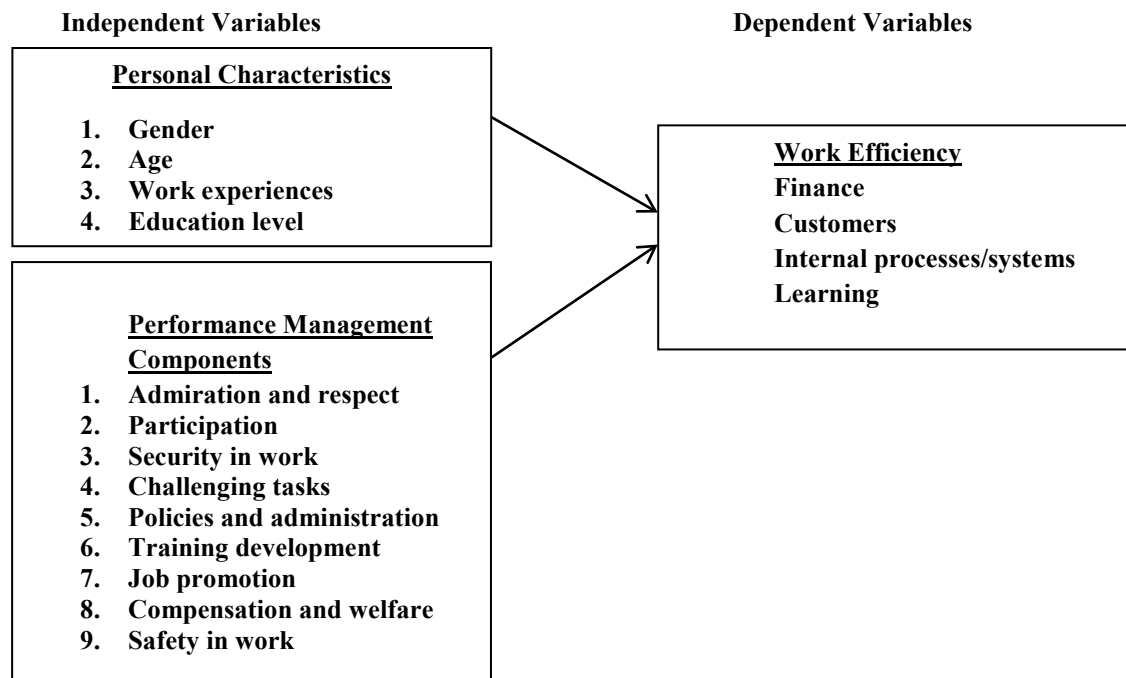
## 3. Theoretical Concepts Concerning Performance Management Components

Supattra Chanrod [7] viewed that performance management components should include: 1. the nature of work, the responsibilities, and the major and minor missions or work processes of different positions 2. amount of works required from the positions 3. specific qualifications suitable for the positions such as qualifications and experiences , and 4. the nature of the work whether or not the machines are required, the complexity of the work, and the operating environment. she discussed the factors that affected the efficiency of the operations of an organization. Those factors should include 1. personal characteristics which generally depends on the factors related to their needs, interests, values, ingenuity and attitudes towards the conditions of work as well as the supervisors 2. the nature of the work which is regarded as a tool to reflect the effectiveness and job satisfaction – the assignment of important tasks or the support for the personnel’s advancement 3. the conditions of work which are indicative of the effectiveness of the organizational structure, policies, attitudes of the management team and staff, and the working atmosphere, and 4. the styles of supervisors or chief executives which reflect the types of the leaders as well as personalities that affect the performance of the subordinates.

To summarize, good performance management components are likened to the internal motivation for the employees leading to good performances, which are rewards for the employees themselves. If the employees

are unable to produce desirable results, they are willing to put more efforts to overcome the dissatisfaction to reward themselves with better quality of work.

From the literature review and related research, the conceptual framework can be summarized as follows.



**Figure 1** Conceptual framework for the research

### 3. Methods

This research study was conducted as quantitative research, employing Survey Research and questionnaire as a tool to collect data from 950 employees of Nong Pho Ratchaburi Dairy Co-operative Limited (Under the Royal Patronage). The sample size was calculated using the formula of Krejcie and Morgan [8] with the possibility of 5 percent deviation. Thus, the sample size contained 282 sets in total. Stratified random sampling was used in order to obtain the balanced proportion of each department.

The questionnaire used to collect data in this research study was constructed through the theoretical concepts, related research, and the research conceptual framework. The contents collected by the questionnaire can be divided into 3 parts.

Part 1: Questions about personal characteristics of the respondents, including gender, age, status, work experiences, educational levels, using closed-ended questions in a format of check-lists.

Part 2: Questions on the opinions of the Performance Management Components to find out the extent of opinions concerning the Performance Management Components that influence the work efficiency of the employees. This set of 27 closed-ended questions contain 5-rating scales of check-lists.

Part 3: Questions about the level of work efficiency of the employees of Nong Pho Ratchaburi Dairy Co-operative Limited (Under the Royal Patronage). This set of 10 questions contain 5-rating scales of check-lists.

The questionnaire was verified for the validity of the instrument. It was submitted to 3 experts to review its accuracy, content validity, comprehensiveness, and was tried out with 30 participants who were not the actual samples, yet shared certain similarities. The results obtained from the participants at this level were tested for the reliability of the tool using Cronbach's alpha. As a result, the reliability in the aspect of the Performance Management Components was 0.82-0.88 and 0.75-0.83 for the work efficiency of the employees. This proved that the questionnaire was qualified in terms of both content validity and reliability.

Statistics used in data analysis included:



1) descriptive statistics, which analyzed demographic characteristics of the respondents through frequency and percentage (%). The results were then presented in tables with descriptions. Descriptive statistics also analyzed the characteristics of dependent and independent variables, using mean and standard deviation (SD).

2) Inferential statistics were used to compare the mean of the opinions concerning the Performance Management Components that were related to the work efficiency, classified by personal factors, including gender, age, status, work experiences, and education level. The t-test was used for the variables classified into two groups and One Way Analysis of Variance was used for the variables of 3 groups and above. When significant differences were detected, the differences in pairs would be analyzed, using Least Significant Differences: LSD. As for the analysis of the level of work efficiency of Nong Pho Ratchaburi Dairy Co-operative Limited (Under the Royal Patronage) based on the factors of the Performance Management Components, Stepwise Multiple Regression Analysis was used.

#### 4. Results and discussion

##### Part 1: Personal Characteristics of the Respondents

The results showed that most of the respondents were females (64.90%), with age range of 20-30 years old (31.20%), single status (43.60%), 4-6 years of work experiences (28.00%), and education level below high school (27.00%).

##### Part 2: The Results from the Analysis of Levels of Opinions Concerning Performance Management Components and Work Efficiency

**Table 1** Performance Management Components of Employees of Nong Pho Ratchaburi Dairy Co-operative Limited (Under the Royal Patronage)

Performance Management Components	Mean	SD	Order
1. Admiration and respect	3.69	0.87	2
2. Participation	3.55	0.86	4
3. Security in work	3.79	0.92	1
4. Challenging tasks	3.63	0.93	3
5. Policies and administration	3.48	1.09	5
6. Training development	3.42	1.01	7
7. Job promotion	3.30	1.12	8
8. Compensation and welfare	3.28	1.09	9
9. Safety in work	3.48	1.06	6
<b>Total</b>	<b>3.51</b>	<b>0.99</b>	

From Table 1, it was found that the mean of Performance Management Components in relation with work efficiency of Nong Pho Ratchaburi Dairy Co-operative Limited (Under the Royal Patronage) was at a high level ( $\bar{X} = 3.51$ , S.D.= 0.99). The three aspects with the highest means were security in work ( $\bar{X} = 3.79$ , S.D.= 0.92), admiration and respect ( $\bar{X} = 3.69$ , S.D.= 0.87), and challenging tasks ( $\bar{X} = 3.63$ , S.D.= 0.93), respectively.

### Part 3: Results of the Analysis of Opinions on Work Efficiency of the Employees of Nong Pho Ratchaburi Dairy Co-operative Limited (Under the Royal Patronage)

**Table 2** Work Efficiency of the Employees of Nong Pho Ratchaburi Dairy Co-operative Limited (Under the Royal Patronage)

Work Efficiency	Mean	SD	Order
Finance	4.10	0.65	1
Customers	3.62	1.03	3
Internal	3.63	1.08	2
Learning	3.42	1.18	4
<b>Total</b>	<b>3.69</b>	<b>0.98</b>	

It was found that the overall mean score of the opinions on work efficiency of the employees of Nong Pho Ratchaburi Dairy Co-operative Limited (Under the Royal Patronage) was at a high level ( $\bar{X} = 3.69$ , S.D.= 0.98). The mean scores of work efficiency were found at a high level in 4 aspects, including finance ( $\bar{X} = 4.10$ , S.D.= 0.65) internal processes/systems ( $\bar{X} = 3.63$ , S.D.= 1.08) customers ( $\bar{X} = 3.62$ , S.D.= 1.03), and learning ( $\bar{X} = 3.42$ , S.D.= 1.18), respectively.

### Part 4: Work Efficiency of the Employees of Nong Pho Ratchaburi Dairy Co-operative Limited (Under the Royal Patronage)

The results can be summarized in a form of table detailed as follows.

**Table 3** Work Efficiency of the Employees of Nong Pho Ratchaburi Dairy Co-operative Limited (Under the Royal Patronage) Classified According to Personal Factors

Independent Variables (Personal Factors)	statistics	Dependent Variables (sig)			
		Finance	Customers	Internal Processes/Systems	Learning
Gender	t-test	0.39	0.54	0.19	0.77
Age	ANOVA	0.87	0.08	0.09	0.23
Status	ANOVA	0.18	0.01**	<0.01**	<0.01**
Work Experiences	ANOVA	0.01**	<0.01**	<0.01**	<0.01**
Education Level	ANOVA	<0.01**	<0.01**	<0.01**	<0.01**

The research found that work efficiency of the employees of Nong Pho Ratchaburi Dairy Co-operative Limited was different with statistical significance in terms of personal factors, including status, work experiences, and education level.

### Part 4: Results of the Analysis of Performance Management Components Influencing Work Efficiency of Employees of Nong Pho Ratchaburi Dairy Co-operative Limited (Under the Royal Patronage)

Prior to testing the hypothesis, the researchers conducted multicollinearity test of independent variables, by determining the correlation between variables that did not exceed 0.80.

**Table 4:** Multicollinearity Analysis

	Admiration & respect	Participation	Security	Challenging tasks	Policies	Training	Promotion	Compensation	Safety
Admiration& respect	1	0.75	0.65	0.67	0.69	0.72	0.73	0.63	0.70
Participation		1	0.70	0.76	0.72	0.74	0.74	0.67	0.73
Security			1	0.77	0.75	0.71	0.66	0.66	0.71
Challenging tasks				1	0.77	0.75	0.73	0.68	0.76
Policies					1	0.70	0.78	0.76	0.75
Training						1	0.73	0.76	0.70
Promotion							1	0.72	0.71
Compensation								1	0.78
Safety									1

The results of the analysis revealed that the variables to be analyzed were not affected by Multicollinearity and, therefore, were qualified for further multiple regression analysis.

**Table 5** Performance Management Components Affecting Work Efficiency of Employees of Nong Pho Ratchaburi Dairy Co-operative Limited (Under the Royal Patronage)

	B	SE.	Beta	t	sig
(Constant)	1.01	0.12		8.21	0.00
Safety in work	0.19	0.06	0.24	3.42	0.00
Admiration and respect	0.22	0.05	0.23	4.54	0.00
Training development	0.18	0.05	0.22	3.36	0.00
Policies and administration	0.18	0.05	0.23	3.28	0.00
<b>R=0.83 R<sup>2</sup> = 0.69 ADJR<sup>2</sup> = 0.68</b>					

The research found that Performance Management Components that influenced work efficiency of the employees of Nong Pho Ratchaburi Dairy Co-operative Limited were resulted from safety in work ( $\beta = 0.24$ ), admiration and respect ( $\beta = 0.23$ ), training development ( $\beta = 0.22$ ), and policies and administration ( $\beta = 0.23$ ). The equation had a predictive power of 0.69.

## 5. Conclusions

### Discussion

Performance management components had certain influences on work efficiency of the employees of Nong Pho Ratchaburi Dairy Co-operative Limited. This finding was consistent with a study of Thawatchakul Yukoldham [9] investigating the factors affecting work efficiency of police officers at Bangmod Police Station, Bangkok. Yukoldham's study found that police officers at Bangmod Metropolitan Police Station had overall opinions concerning the factors influencing work efficiency at a high level. When examining each aspect, it was found that 'room for advancement,' relationships with superintendents and colleagues, and compensation and welfare were considered the factors with a high level of opinions.

To establish the security in career for Nong Pho Ratchaburi Dairy Co-operative Limited, it is important that the employment has to be continued until the employees reach their retirement. They had to be satisfied with their current works and positions and had a sense of security in their works, which would contribute to the

achievements of the goals. Besides, the employees had to be acknowledged by their superintendents with admiration and respects. The colleagues should be open to listen to others' opinions and suggestions to improve the performance. If all performance management components were responded appropriately, the employees' opinions would alter and affect the actual performance. If those components were not addressed to sufficiently meet the demands or expectation of the employees, the level of their opinions tended to decrease. The followings were the essential aspects of the discussion regarding performance management components that influenced work efficiency of the employees of Nong Pho Ratchaburi Dairy Co-operative Limited (Under the Royal Patronage).

1. *Admiration and respect.* This aspect influenced work efficiency in a way that employees should receive admiration and respect from their superintendents, co-operation and acceptance from their colleagues, as that would boost self-esteem and encourage the colleagues to enhance the performances. This factor was inseparable from the success in performance and motivation. Somjai Laksana [2] stated that the organizations' achievements or productivity depended largely on motivation through organizational culture, a sense of belonging to or ownership in the organization, and participatory management.

2. *Policy and Administration.* This factor influenced work efficiency. When the organizations had clear policies on administration, appropriate rules and regulations, appropriate resource allocation, effective internal control system, and complaint systems and systems to collect feedbacks from the employees, the employees would develop a sense of belonging to the organizations. That would also contribute to certain behaviors among the employees; they had confidence and faith in the organizations, had discipline in work, adhere by the rules, participate in solving problems and obstacles eagerly and willingly, and had pride and appreciation in organizations. There were certain guidelines on how to effectively improve the administration and management of operations, including the development of organizational culture, personnel management, and motivation building. All these ultimately maximized work efficiency.

3. *Training Development.* This factor influenced work efficiency, as training and development were associated with job positions at a high level. It is, therefore, crucial for the organizations to develop training courses suitable for job positions to enhance work efficiency of the employees. The training should be primarily concerned with the outcomes, so that the trainees focused on the application of lessons learned the training into actual performance. Trainings had to be provided on a constant basis to respond to the rapidly changing information and technology. In other words, the personnel should be equipped with knowledge and skills necessary for effective delivery of performance and at the same time were provided with useful and updated information and technology. Providing the employees with trainings as needed and appropriate for each function could be a mechanism to attain effective and efficient performances in terms of service, resource management, and administration. Worachit Nongkae [10] stated that all these traits related to the knowledge, ability, skills and expertise of the person are essentially derived from the study, training, and the accumulated experience.

4. *Safety at work.* This factor influenced work efficiency of work in a way that strict safety control system was required in all organizations. Each operational process should be monitored and appropriate steps should be taken when accidents in workplace occurred.

## **Suggestions**

### **1. Suggestions for the Application of the Research Results**

1.1 Though work efficiency of the employees of Nong Pho Ratchaburi Dairy Co-operative Limited (Under the Royal Patronage) was found at a high level, it is advisable that the Co-operative continue with the development of the employees' efficiency to maximize the overall work efficiency of the organization.

1.2. As the differences in personal factors of gender, age, status, work experiences, and education level contributed to differences in terms of performances with statistical significance, the Co-operative should be more attentive on these personal characteristics. It is important that the Co-operative effectively identify the needs of different age range and respond appropriately to those needs, as that will affect the satisfaction of the employees and their inputs for increased productivity. In regard to education, the employees should be supported with an opportunity to further their education or attend evening classes. The employees with long work experiences with the Co-operative should be rewarded with raised salaries or increased welfare. That could encourage the employees to work for the Co-operative longer.

1.3. Regarding Performance Management Components that influenced work efficiency of the employees of Nong Pho Ratchaburi Dairy Co-operative Limited (Under the Royal Patronage), the factors with

statistical significance were safety at work, admiration and respect, training development, and policy and administration. The factors that should be improved were participation in work, security in work, challenging tasks, job promotion, and compensation and welfare, respectively.

## 2. Suggestions for Further Studies

2.1 As the nature of this research is cross-sectional study, it is recommended that a study in the related field should be re-conducted in a certain period of time in the future to investigate the performance management components that will influence work efficiency of the employees of characteristics affecting the efficiency of the employees of Nong Pho Ratchaburi Dairy Co-operative Limited (Under the Royal Patronage).

2.2 As this research study focuses only on quantitative research, qualitative research should be conducted in the future to supplement the in-depths results.

## References

- [1] Nong Pho Ratchaburi Dairy Co-operative. **History Nong Pho Ratchaburi Dairy Co-operative**. [cited 2017 Jan 3]. Available from: <http://www.nongpho.com/index.php/history> (in Thai). 2017.
- [2] Somjai L. **Improvement of Work Efficiency**. Bangkok: Thanachat Printing. (in Thai).2001.
- [3] Priyaphorn W. **Personnel Management Psychology**. Bangkok: Bangkok Media Center (in Thai).2001
- [4] Pasu D. **Balanced Scorecard: In-Depths Practices**. Bangkok: Chulalongkorn University Press. (in Thai).2003.
- [5] Kaplan, Robert S, Norton DP. **The Balanced Scorecard: Translating Strategy into Action**. Boston, MA .: Harvard Business School Press.1996.
- [6] Alongkorn M, Smit S. **Performance Evaluation: Concepts, Principles, Methods, and Processes**. Bangkok: Technology Promotion Association (Thailand-Japan). (in Thai).2005.
- [7] Supatra J. **Causal Factors Influencing Work Efficiency of Support Personnel in Loei Rajabhat University**. (Thesis). Retrieved on July 2, 2017 from ThaiLis. (in Thai).2009.
- [8] Krejcie RV, Morgan DW. Determining Sample Size for Research Activities. **Educational and Psychological Measurement**,1970. 30, 607-610.
- [9] Thawatkul Y. **Factors Influencing Work Efficiency of Policeman at Bang Mot Metropolitan Police Station, Bangkok**. Master of Business Administration. Thonburi Rajabhat University. (in Thai).2009.
- [10] Worajit N. **Factors Influencing Primary Health Care Performance in the Role of Public Health Volunteers in the Villages in Khon Kaen Province**. Master of Arts Thesis, Department of Industrial and Organizational Psychology, Thammasat University. (in Thai).1997.

# The Effectiveness of Public Policy Implementation for the Repayment Management Model to Student Loans fund

Opad Meechao<sup>1,\*</sup>

<sup>1</sup>Doctoral students of Philosophy (Management) Siam University

## Abstract

This research aims 1. Study of Effectiveness of Public Policy Implementation. The repayment of the loan fund loans for education 2. Modeling Effectiveness of Public Policy Implementation. The repayment of the loan fund for student loan fund. Researchers used quantitative research from student loan student loan fund to pay the debt and repay it. Total of 410 cases using simple random. The instrument used in the research questionnaire created data were analyzed by percentage, and path analysis by using structural equation modeling.

The results showed that the 1. The effectiveness of public policy implementation for the loan fund loan for education receive influences include positive form attitude toward the policy of loan ( $\beta = 0.85$ ). The quality communication system ( $b = 0.60$ ). The trust to repay loan ( $b = 0.47$ ). The satisfaction of the policy the repayment of debt ( $b = 0.24$ ). The create a good image for the loan fund ( $\beta = 0.24$ ) and development of personnel in the operation ( $b = 0.15$ ). Statistical significance the predictive power of the model, 70 percent 2. Effectiveness of Public Policy Implementation need to focus on to create a good image for loans, development of personnel in the operation, quality communication system, attitude toward the policy of loan, trust to repay loan and satisfaction of the policy the repayment of debt to combination.

**Key Words :** Student Loans Fund , Effectiveness , Public Policy

## 1. Introduction

The importance of education of the people be identified to rights and freedom in education in the category 49 3 section of the constitution act, which provided that 2007 "A person shall have the right to receive education always not less than 12 years. The state must provide a thorough and quality without charge to the poor, the disabled disability or condition difficult to get the rights of exactly one barrier and the support from the state to get the equal to other people. The education and training of professional organizations or private study on the choice of the people self learning and lifelong learning. Shall be protected and promote appropriate from the state [1] but the basic education to the public also was not adequate to the needs of the people. Because both the industrial and business sectors. All need the human resources with higher knowledge of basic education to be part of organization development and the country.

The student loan fund set up by the cabinet on 28 March 1995 by the Ministry of finance, Ministry of education and the Ministry. The consideration on the basis of the importance of human resource development. To support economic growth and increase the competition ability of the country. In order to solve the problem of the social inequality in education. Resolved to share in the principle of the educational loan fund by the Treasury, Ministry of education and ministry.

Agency is responsible for, and bank charge manage the loan borrowing. Later, the cabinet on 16 January 1996 to start action fund in the manner aforesaid capital section 12 of act b.e. 2491-ins money Fund began loans since the academic year 1996 with an annual budget of more than 3,652 million has been allocated a budget contribution is yearly as required by the basic principle that "to loan to students who come from families with low income. For the study since high school. (Both general and vocational) through an undergraduate degree in the country. Including non-formal education Due to the junior high school curriculum and the types defined by the Ministry of Education, students must be repaid with interest rates low graduation ". Then the government has foreseen that fund loans for education benefits for students. Students who are truly disadvantaged, therefore, promulgated the Act funds loans for education, b.e. 2541 resulted in the Fund as a legal entity under the supervision of the Ministry of finance, and structured operation, stable and fast growth, and flexibility in practice. From the first Office was located at the Comptroller General's Department in the year 2001 Fund loans for education have moved to a new Office at Government Housing Bank headquarters until the present.

This fund is the important mechanism of the government that helps support and maximize the chances to develop the education of country youth education quality standards equally . The vision of the organization is "a leading financial To create educational opportunities for the development of Thai society. " In addition, the fund has also announced the mission of the fund for educational loans .That is, "education loans for students. Student funding and management system with modern technology to meet the needs of the economy and society Thailand. By maintaining financial discipline and good governance ".

\* Corresponding author; e-mail: Opad@hotmail.com

The key issue for the Student Loans fundat present, it is a matter of chargebacks from students who are borrowing. The problem with students who graduated in the class. Diploma of Higher Education Both are graduates who are competent both seniority and qualifications. But there are also a number of students defaulting on loan repayments to the Fund. Such issues pose to study various problems that arise with other loans factors that manage public policy.

The aim is that such research will lead to a recommendation to fund loans for education and students who borrow from this fund to be able to adjust the strategy process management Fund The trick to changes in context. This will bring benefits to the organization and finances of the country. It also helps to promote an academic career that would benefit the country in the field of education management and to guide new students to prepare well for the debtor. A graduate of the personnel, the quality of the nation. Have the ability to send money back loans on time in order to fund working capital for the next generation of students. And to eliminate the Fund's fiscal burden for the country in the future.

## 2. Objectives

- 2.1 To study the effectiveness of public policy implementation for the loan fund loan for education.
- 2.2 To create an effective public policy into practice implémentation for the loan fund loan for education.

### Hypothesis in the study

1. The effectiveness of loan repayment of loan funds for education influenced by the trust to repay the loan satisfaction with the policy of settlements. And attitudes toward the policy of loan repayment of loan funds for education.
2. Attitude towards the policy of loan repayment of loan funds for education. Influenced by creating a good image for loans. The development of personnel in the operation. And communications technology and quality.

### Documents and related literature

The research was conducted research related to creating a framework for research. This strand of the literature review is divided as follows.

#### The concept of the good corporate image

The image was taken into account as one element in the administration. Contributing to business organizations continue to be progressive and solid. Especially for big business, which is associated with many citizens and moreover, the administration official also beat up the image of the virtual assets, a value which is hard to estimate the number as the account has a positive image.

Kotler [2] the meaning of the image, that is the whole of beliefs, ideas, and the impression that people are against something which the attitudes and actions of any person we have on that will have high relevance to the image of what is happening in the mental image of a recipient of the substance or interpretation of which is stored in the memory. From the impressive and is the interpretation of the person a specific object from the data assessment process of each individual. When linked with the concept of a unique organization that is meant to show the identity of the Organization through the symbol of the Organization, such as communication and behavioral cues that organization tries to communicate to public awareness by the perception of the public is the group arising from the interpretation and evaluation of data in the mind of the recipient organization's unique material there himself.

Corporate image to get attention and be studied by scholars management and communicate more. By creating a unique and distinctive brand image, organization and appropriate able to make a difference and create value for goods and services. Including strengthening confidence and loyalty to the organization. Encourage investment Attract personnel who are able to attend and create incentives for employees. Askegaard and Christensen [3] Organizations need consistent brand image in line with the corporate strategy and corporate vision usually create organizations to differentiate and stand out in the eyes of all the stakeholders of the organization.

The study concluded that the image of the organization refers to the perception and impression of the organization. The process of perception and interpretation arising from communicating the identity of the organization voluntarily and involuntarily. The organization has communicated to the stakeholders both inside and outside the organization itself.

#### The concept of human development

Concepts and Research shows that many people are critical factors for managing the organization. The personnel in the organization is like the people in society who need management systems. Which makes the operation can achieve the objectives laid down their best. cheapest And promote the effectiveness of the Organization. This research study variables personnel in the organization. By focusing on the behavior of a member of staff in the organization Behavior is a good member of the organization. The behavior of the function and behavior of social support. As an expression of personnel actions voluntarily. No compensation was involved This behavior is required of every organization with members in the organization. It is helping the organization run smoothly. Because when organizations are faced with conditions that pose no mobility behavior, it can be a great help to them. Moreover, the key elements of good behavior for a member of staff in the organization is offering help to others. Without hope of return to what he has done. These demonstrate individuality. Who cares in supporting and co-workers. To reduce friction and keep the organization in which he lived. This will lead to organizational effectiveness research has studied many aspects

of organizational performance. This allows those organizations can survive. Smith and Organ [4] Studied the behavior of a member of the organization. The results of such behavior can be divided into 2 categories: helping others without expecting results and compliance with the rules of the organization. Podsakoff, Ahearne, MacKenzie [5] Said the behavior of the members of the organization are 7 aspects.

1. Personal initiative A person's behavior in the initiative and to participate
2. Loyalty to the organization
3. Behavior Support
4. Compliance with the rules of the organization.
5. The water sportsmanship. The acceptance of the idea of the group
6. The good society organizations
7. Self Development. To be used in the work.

#### **The concept of communication and technology**

Communications between different organizations can have an impact on the holding. The organization was born of a combination of cultural differences such as language, ideas, values, norms, perceptions, interpretations, live and conduct themselves, and for the administration and operation of the organization would not have happened if. lack of communication Found that communication is connecting people within the organization. Each department Each branch branches together The lack of communication was sent to the administration and management resources to solve the problem can not be restructured. In addition, the staff just could not make the purpose of the organization is achieved. Likewise, the sender and receiver are the same, then everything is possible. If each person has a different way of education and culture. It can be seen that the communication has a role in managing organizations so that organizations are able to achieve the desired goal and resulted in the high performance organization.

Downs and Hazen [6] created Communication satisfaction survey by measuring elements 8 reasons.

1. Overview of organization in general. A question that reflects the information related links with all functions of the organization.
2. Feedback data private. This element is related to personal achievement, and how he is accepted by the organization.
3. Healing, casting the organization. Reflect the satisfaction of the individual. With the information he received. On the organization and environment aspects.
4. Communication with superiors. A two-way communications with the bosses.
5. The atmosphere of communication. A state of communication at all levels of the organization. To encourage any goals.
6. Communication horizontally. An informal communication between colleagues together.
7. The quality of the media. This composition reflects the organization personnel in recognition and function effectively.
8. Communicate with subordinates. A two-way communications with subordinates.

The characteristics of the media as a tool to convey reaction and the reverse. The causes of the problems arising from imperfect communication in organizations are often attributed to distort the news to vary from reality. The rumors of the parts in the organization, information unnecessarily. Having a narrow mind of the people involved in the communication. The recipients of bad news The problem of using words to convey ambiguous or unclear. The atmosphere of communication has to hide hide, suspicion, not straightforward. The problems about the status of the messenger and the behavior of the bosses like decide their attitude Don't listen to the opinions of others.

#### **The concept of attitude**

Attitude refers to a state mental health of a person caused by learning to respond to individual items or specific events, either in kind like or do not like the normal person would have to have an attitude towards things. one thing that is always related to everyday life. Psychologists who have studied the group's attitude to the multiple meanings below

Schiffman and Kanuk [7] Attitude is the bias resulting from learning. Make the behavior characteristics that like or dislike toward one thing, and have defined the elements and sets the attitude for 3 parts.

1. Cognitive Componentare Knowledge ,Perception, Beliefs May vary each person. The speed and perception will receive from the experience and information related to the multiple sources of information. And this knowledge will affect the beliefs.
2. Affective Component are Knowledge ,Emotion or feeling of consumers, ideas or something, such as in the story of love and emotions towards the.
3. Cognitive Component or Behavior or Doing to reflect the trend will be the behavior of consumers or trend action expression or inclining to buy the product.

For a change of attitude that Wandeei Kwaekamkae [8] offer that people's attitudes are developed by the three aspects together.

1. the person has the opportunity to contact your relationship with another person.
2. The origins of the individual relay exemplary actions or opinions of others as their own.
3. That people try to satisfy their.

#### **The concept of trust**

Trust means a person with the confidence of one who is convinced of its reliability honesty and sincerity of things [9] Which could be shelter in a particular story, we are disappointed by the actions of both sides.[10] Everyone



must have scope definition of trust if a person born and disappointment of the trust, the trust will decrease or disappear, respectively. Therefore, trust so depending on what one person, expect, so understanding the expectations of others that are very important to build trust. The expectations of the people is established to meet the demand so the expectation is what related to can not separated from each other when the human needs. Expectations will increase. However, human needs when the need for it. Always expect higher respectively.

Factors that affect the trust is the ability to influence things which rely on the skills, knowledge and behavior of individuals. Good sense that someone wanted to make us so, we trust to act consistently. Treated with sincerity and straightforward.[11]

Trust is the fact that there are a number of confidences by the people who participate in the exchange of reliability and integrity, which has a close relationship and are particularly important in order to determine the characteristic obligation. To illustrate the relationship between the customer and the organization.[12]

Trust is a fundamental principle of relation communications to provide customer with the services. The organization will need to learn the theory of intimate relationships familiar to win customers ' hearts, which contains 5C as follows.[13]

1. communication, the employee should be able to communicate with customers in a way that makes it warm customers. The disclosure represents a sincere and ready to provide help to customers so that both parties are willing to express your feelings and thoughts together.

2. The attention and giving attention and ready to give it. The property consists of an intimate relationship. Generosity, warmth and a sense of protection. As a result, customers feel good, that is, the organization may express these feelings from what little is observed.

- 3 Commitment of the unaffiliated customer by the Organization should not tolerate. Waste interests to maintain good relationships with customers.

4. Comfort attention customers will make customers feel comfortable. The customer will feel happy warm, confident, firm paid services. Most customers evaluate the comfort from the good services of the organization.

5. Conflict resolution if the organization can make customers feel "Make yourself comfortable as at home." It would be better that the organization must solve the conflict situation with customers. The organization should take the responsibility to act before that. If a customer found nothing suspicious or amuse in products and services that customers think to compare. Ask the customer quickly asked to keep employees get exponentially quickly before the customer will feel angry or unhappy in goods and services.

#### **The concept of satisfaction**

Office of the Royal Society [14] definition of satisfaction is the knowledge that there is happiness or satisfaction upon receiving the success or get what you want, cause positive and negative. Negative emotions are not feeling satisfied. Positive feelings are feelings that once occurred to cause happiness is the feeling that there is a reverse system cause positive feelings. See that happiness is the feeling that effect personal and complex than any other system, positive feelings, relationships, sense called satisfaction. By satisfaction occurs when there is a positive rather than a negative sense, always. Recap the concepts about the satisfaction that the feeling of love or a person who has to work, and the elements or other incentives if the work or those elements meet the requirements of the individual, that individual will be born in satisfaction to dedicate the time. Including their intellect, their job to achieve quality objectives. Incentives for the use of a tool, encouraging individual satisfaction from the study are as follows:

1. Material inducement including money, goods or physical condition to entrepreneurs activities.

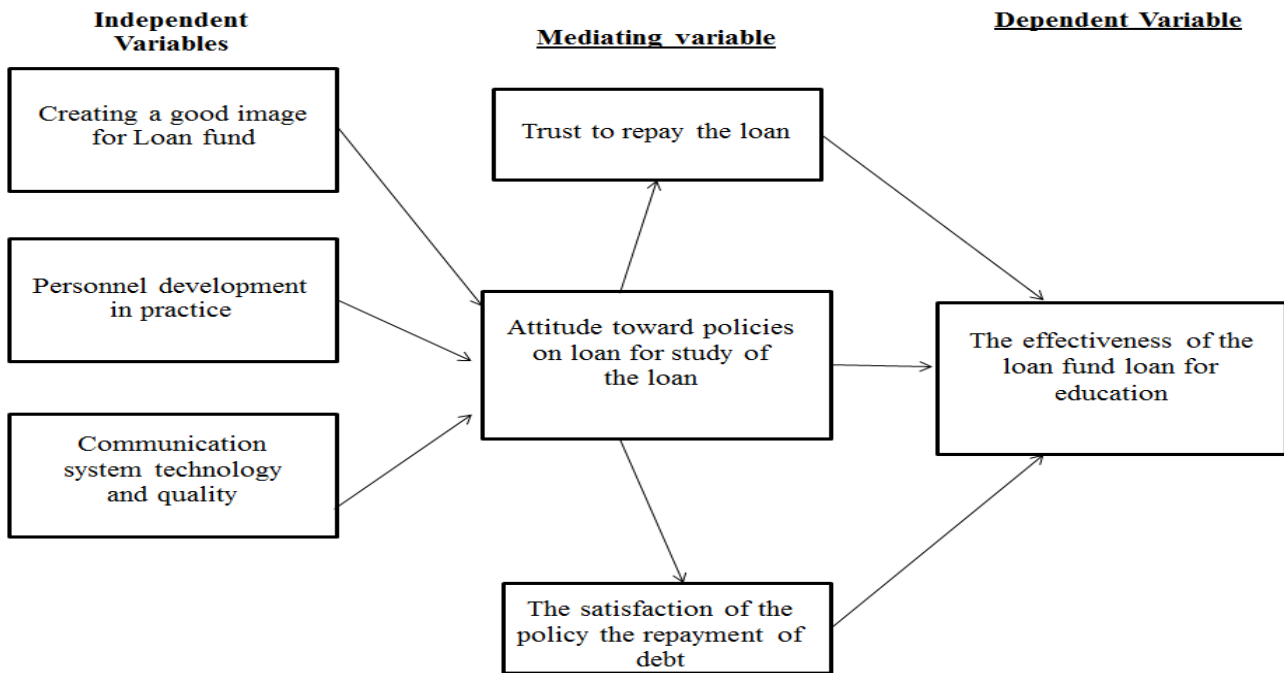
2. Desirable physical condition is engaged in environmental activities which is an important one causing physical pleasures.

3. Ideal benefaction means different things to meet the needs of individuals .

4. Association attractiveness is a Whether friendly association with the event. This will cause a binding condition is satisfied and coexistence. The satisfaction of individual or social stability in society. It makes sense to have the security and stability of activity.

Research in the past, have pointed out that Customer satisfaction comes first trust [15] have examined the positive impact of satisfaction which affect the trust. In the environment of transactions, [16] if the customer experience is the satisfaction of traders. They have a high level of trust on the basis of the experience. The result, they tend to come to buy. Besides, customer satisfaction, these will be the trust. And cause relations long-term traders[17].

For a review of the literature data can be used to create all the concept as follows.



Picture 1 framework in research

**3. Methods**

This research is a survey research by population research include students who borrow money from loan funds for education. In Bangkok To find a sample size because it does not know the size of the population that is so clearly. Use the formula for the size of the sample group cochran [18] 385 number of research by increasing the size of the sample group, 10 percent more, so get the samples must be stored in total, 420 or more examples. When calculating the sample size already. Researchers keep data from student loans and the debt was and in Bangkok. In equal proportion sampling relies on simple and using the database, the list of students. Krungthai Bank the data analysis of this research. Study equation form of variable linear structure. The researchers have used the program to analyze the LISREL Version 8.52 allows for the creation of the model equations Linear structure(Structural Equation Modeling: SEM)Or structural analysis of causal relationship between variables.

Research test content validity to consider the consistency between the questions and issues in research content desired to experts, both 5 cases. The questionnaire through quality inspection by experts only one remained and joint improvement to create a high effective and try out with students who borrow money from the fund for educational loans in Nakhon Pathom province. Which is not the samples were 40 cases. The to reliability value between 0.73-0.91

**4. Results and discussion**

The results showed that most of the respondents were female (% 65.71) studies in bachelor's degree level (per cent 72.38) in the age group of 21-22 years. (of 33.81) occupation of most of the parents is the trading of 35.71) most respondents living with parents and 59.52). The period to recover the loan fund for education in the 4 years (% 38.10), most family members one loan loan fund for education. Except for the 62.86 (percent) and most members in the family (not counting the answer) (percent 59.76).

**The results of the hypothesis testing model Effectiveness of Public Policy Implementation for the Repayment Management Model to Student Loans fund**

Researcher has defined symbol and meaning of latent variables, and the variable as follows

Table 1 Meaning of the symbols in the observed variables.

Observable Variable	Meaning
image01	To create a good image to benefit personally
image02	To create a good image to benefit the society and the environment.
dev01	The use of human resources quality.
dev02	Developing work skills
dev03	Treatment of human resources to remain with the organization.
commun01	Communication system with quality to healing, shaped the organization.
commun02	Communication system for the quality of communication.
commun03	Communication system with quality to the quality of information.
atti01	Knowledge attitudes understanding,

atti02 Attitude toward feeling.

**Table 1** (continue).

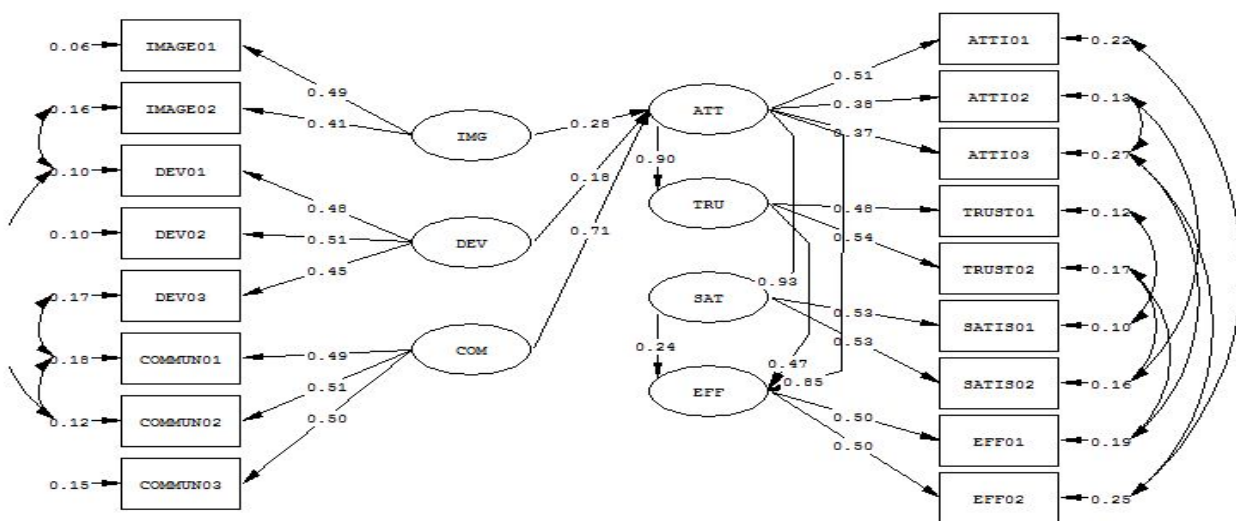
Observable Variable	Meaning
atti03	Behavioral attitude.
trust01	Trust in the repayment of debt
trust02	Trust in response to demand.
satis01	The experience of satisfaction.
satis02	Creating a good relationship
eff01	The cost effectiveness of using available resources.
eff02	Productive assets
Latent Variable	Meaning
IMG	Creating a good image for the loan fund.
DEV	The development of personnel in the operation.
COM	System communication quality.
ATT	Attitude policy on repayment of loans.
TRU	The trust to repay loan.
SAT	The satisfaction of the policy the repayment of debt.
EFF	The effectiveness of policy for repayment.

The researchers analyzed the effectiveness of public policy implementation the repayment of the loan fund loans for educational way Maximum Likelihood The program LISREL 8.52 compared to the harmony between the developed model. On the basis of empirical data to validate values. Chi-square / df, CFI GFI, AGFI, RMSEA and SRMR which analytical results are summarized below.

**Table 2** The analysis shows the index value of the overall model after model calibration.

Index of Harmony	Criterion	Measured Value	Result
Chi-square/df	< 3.00	1.87	Pass
CFI	≥ 0.95	0.99	Pass
GFI	≥ 0.95	0.95	Pass
AGFI	≥ 0.90	0.90	Pass
RMSEA	< 0.05	0.038	Pass
SRMR	< 0.05	0.032	Pass

Considering the index of harmony models from the table 4.13 found. The model was fit to the empirical data, the 6 index criteria of acceptance Chi-square = 179.66 , Chi-square/df. = 1.87 , CFI = 0.99, GFI = 0.95, AGFI = 0.90, RMSEA = 0.038 and SRMR = 0.032



Chi-Square=179.66, df=96, P-value=0.06107, RMSEA=0.048

**Figure 1** The Effectiveness of Public Policy Implementation for the Repayment Management Model to Student Loans fund model after the upgrade.

**Table 3** Direct Effect, Indirect Effect and Total Effect for The Effectiveness of Public Policy Implementation for the Repayment Management Model to Student Loans fund.

Factor effect	Attitude toward policies on loan for study of the loan (R <sup>2</sup> =0.87)			Trust to repay the loan (R <sup>2</sup> =0.92)			The satisfaction of the policy the repayment of debt (R <sup>2</sup> =0.86)			The effectiveness of the loan fund loan for education (R <sup>2</sup> =0.70)		
	DE	IE	TE	DE	IE	TE	DE	IE	TE	DE	IE	TE
Independent Variable												
To establish a good corporate image marketing.	0.28		0.28		0.25	0.25		0.25	0.25		0.24	0.24
IMG (t-value)	3.92		3.92		3.70	3.70		3.71	3.71		2.98	2.98
Personnel Development	0.18		0.18		0.16	0.16		0.16	0.16		0.15	0.15
DEV (t-value)	2.62		2.62		2.60	2.60		2.60	2.60		2.58	2.58
Communication system	0.71		0.71		0.64	0.64		0.64	0.64		0.60	0.60
COM (t-value)	5.17		5.17		5.03	5.03		5.01	5.01		4.88	4.88
Attitude				0.90		0.90	0.93		0.93	0.85		0.85
ATT (t-value)				6.82		6.82	7.12		7.12	5.96		5.96
Trust										0.47		0.47
TRU (t-value)										3.99		3.99
Satisfaction										0.24		0.24
SAT (t-value)										3.69		3.69

DE = Direct Effect, IE = Indirect Effect, TE = Total Effect, \* p <0.05, \*\* p<0.01

The results showed that Effectiveness of Public Policy Implementation The repayment of the loan fund loans for education. Influenced by the positive overall. Attitude policy on repayment of loans(β= 0.85)Communication system technology and quality(β= 0.60)Trust to repay the loan(β= 0.47)The satisfaction of the policy the repayment of debt(β= 0.24) Creating a good image for Loan fund (β= 0.24) and Personnel development in practice (β=0.15) Significantly

While The satisfaction of the policy the repayment of debt Influenced by the overall positive attitude towards the policy of loan repayment (g =0.93) Communication system technology and quality(g =0.64) Creating a good image for Loan fund(g =0.25) and Personnel development in practice(g =0.16)Significantly.

Trust to repay the loan by the overall positive attitude towards Attitude toward policies on loan for study of the loan

(g =0.90)Communication system technology and quality(g =0.64) Creating a good image for Loan fund(g =0.25) and Personnel development in practice(g =0.16)Significantly.

And Attitude toward policies on loan for study of the loan by the overall positive attitude towards Communication system technology and quality(g =0.71) Creating a good image for Loan fund(g =0.21) and Personnel development in practice(g =0.18)Significantly.

**5. Conclusions**

The Effectiveness of Public Policy Implementation for the Repayment to Student Loans fundTwo factors caused by internal and external. Affecting the loan. Internal factors the students to be aware of their responsibilities towards debt repayment. Such factors starting attitude. [19]Trust [10] and the satisfaction of the policy the repayment of debt[20] The second factor is an external factor which caused the need for better management of the Fund. By creating a positive image [2] and The development of personnel in the operation to provide services to the students [21]The development of communications technology and quality to provide access to student loans.[22]

**Suggestions**

**5.1 Suggestion to bring the research to use**

1. The results showed that the Effectiveness of Public Policy Implementation for the Repayment to Student Loans for education and good attitude resulting from the borrower, therefore, before considering the loan. One of the features is to assess the attitudes of the borrower may be assessed in order to reflect conditions before the loan. In addition to assessing only grades only. If the loans are aware of and understand the source of the repayment of the loan

fund's loans to study and understand the responsibilities and roles of their debts on time for juniors, it will make a contribution to the policy has targeted success.

2. Factors such as the common element of trust and satisfaction with the loan funds. Such factors as a consequence of having a positive attitude. The Student Loan Fund may have regard to the evaluation of two such factors. And find a way to develop trust. And satisfy the repayment of loans.

3. The external factors that influence the effectiveness of Public Policy Implementation for the Repayment Management Model to Student Loans fund to the most influential including communication system quality so adding a channel to build understanding and create a positive attitude is what. Educational loan fund need to act first. Even in the construction of information through a special application application can easier is the opportunity of this one in the development of the effectiveness of public policy implementation.

### 5.2 Suggestion for the further research

1. The research focuses on the quantitative research to study the effectiveness of public policy to conduct in-depth. There should be a qualitative research component. by may perform in-depth interview or a group discussion on the policy loan funds for education.

2. Such research has specific boundaries in Bangkok. So if there is a dimension that has clear talents may be studied in the province and other provinces.

### Reference

- [1] **Constitution of The Kingdom of Thailand. (Volume1)** Bangkok : The publisher's cabinet and Government Gazette. (in Thai).2007.
- [2] Kotler P. **Marketing management.**(10<sup>th</sup> ed.).the University of Michigan. Prentice Hall of India.2000.
- [3] Askegaard S, Christensen LT. Corporate Identity and Corporate Image Revisited : a Semiotic Perspective. **European Journal of Marketing.** 2001.35,3/4 (March-April 2001) : 292-315.
- [4] Smith CA, Organ DW, Near JR. Organizational Citizenship Behavior: Its Nature and Antecedent. **Journal of Applied Psychology.** 1983. 68 (4): 653-663.
- [5] Podsakoff PM, Ahearne M, MacKenzie SB. Organizational Citizenship Behavior and the Quantity and Quality of Work Group Performance. **Journal of Applied Psychology.** 82,2 (April 1997) : 262-270.
- [6] Downs, C.W. and Hazen, M.D. ,A Factor Analytic Study of Communication Satisfaction. **The Journal of Business Communication.** 14,3 (April 1977) : 63-73.
- [7] Schiffman and Kanuk .**Consumer Behavior.** (8<sup>th</sup> ed.).Upper Saddle River, NJ.Prentice Hall.2004.
- [8] Wandee k. **Knowledge, attitudes and practice about food intake of the students in the junior secondary school-class opportunities Bangkok** .Electronic Thesis Database(Ramkhamhaeng University). (in Thai).2001.
- [9] Dwyer FR, Tanner JF. Business Marketing Connecting Strategy, Relationships and Learning. (2<sup>nd</sup> ed.)Irwin. McGraw-Hill.2009.
- [10] Reina D, Reina M. **Trust and Betrayal in the Workplace** .M. San Francisco: Berrett-Koehler. 1999.
- [11] Mayer RC, Davis JH. The effect of the performance appraisal system on trust for management: A field quasi-experiment. **Journal of Applied Psychology,**1999. 84(1), 123-136.
- [12] Morgan RM, Hunt SD. The Commitment-Trust Theory of Relationship Marketing. **Journal of Marketing.** 1994.58, 3 (Jul., 1994). 20-38.
- [13] Warrant S. **Factors that affect the loyalty of Bank customers to EBanking.** Independent Study. Master of BusinessAdministration. Srinakarinwiroot University . (in Thai).2006.
- [14] Royal Academy **Royal Academy Dictionary 2542** . Bangkok :The publisher Nanmee books. (in Thai).1999.
- [15] Garbarino E, Johnson MS. The Different Roles of Satisfaction, Trust, and Commitment in Customer Relationships. **Journal of Marketing.** 63, 2 (Apr., 1999), 70-87.
- [16] Pavlou PA. Consumer Acceptance of Electronic Commerce: Integrating Trust and Risk with the Technology Acceptance Model. **International Journal of Electronic Commerce** .2003.59, (4), 69-103.
- [17] Ganesan S. Determinants of Long-Term Orientation in Buyer-Seller Relationships. **Journal of Marketing.** 1994. 58, 2 (Apr., 1994), 1-19
- [18] Cochran WG. **Sampling Techniques.** Experimental Designs, New York. Cuyano.1953.
- [19] Atipat S. **A study of the attitudes, activities, movement, and rhythm of their teachers use instructional practices, assessment guidelines.** Thesis Master of Education. Elementary education. Srinakarinwiroot University. (in Thai).2000.
- [20] Singh J, Sirdeshmukh D. Agency and trust mechanisms in consumer satisfaction and loyalty judgments. **Journal of the Academy of Marketing Science.** 2000. 28, 1, 150-167.
- [21] Wiyakarn T. **Factors that influence the decision to buy the House brand of mobile phone consumers in Bangkok and vicinity areas.** Independent Study Master of Administration Business Major Management Faculty of Business Administration Rangsit University (in Thai).2009.
- [22] Siriwan S. **Organization Behavior.** Bangkok :Teera Film and Cytex. (in Thai).2000.

# Work Motivation of Myanmar Workers in the Food Processing Factory: Case Study of Kasemchai Farm Group Co., Ltd.

Bencharat Buengboran<sup>1</sup>, Assanee Piancharoenwong<sup>1</sup>, Wisit Rittiboonchai<sup>1,\*</sup>

<sup>1</sup>Faculty of Management Science, Nakhon Pathom Rajabhat University

## Abstract

The aims of this study were 1. To study work motivation of the Myanmar workers in the factory of Kasemchai Farm Group Co., Ltd. 2. To compare work motivation of Myanmar workers in the factory of Kasemchai Farm Group Co., Ltd. by individual factors.

The samples used in this study were 108 employees of Kasemchai Farm Group Co., Ltd. who were Myanmar workers, using simple random sampling method. The tool used was a questionnaire developed by the researchers. Data analysis was performed using percentage, mean, standard deviation, t-test, and one-way ANOVA.

The results show that (1) the overall of work motivation of the Myanmar workers in the factory of Kasemchai Farm Group was at a high level (Mean = 3.66). The first three important factors are: supervision (Mean = 3.78), salary (Mean = 3.75), and work position (Mean = 3.71) respectively.

(2) The results show that the overall of work motivation for Myanmar workers is based on years at work. Workers who having longer working years at the factory will be more motivated to work at statistical significance at the 0.01 level.

**Keywords:** Myanmar worker, work motivation, food processing industry

## 1. Introduction

Human resource is a valuable asset and a source of competitiveness advantages, so human resource management takes a major role in enhancing performance. It is a responsibility of organization executives to do management works so as to acquire valuable and potential personnel. Executives have to increase performance of their staff by creating work motivation, especially internal motivation of the staff. This allows the staff to perform effectively.

Good human resource management helps organizations to grow. The recruitment of suitable employees to work with the organizations, the enhancement of staff's moral and loyalty, and the reduction of conflicts between operators and their organization are the causes of peace in the society. An effective human resource management has to fulfill two major objectives – the first one is to satisfy organization's needs so that it can prosper with effective performance ; the second one is to meet employees' needs for earning a living, being safe, being accepted, and being successful by the mean of wage increasing, complaints solving, and social activities holding. Executives have a responsibility to keep quality resources with the organizations as long as possible by using means that suits employees' needs and organization's objectives. [1]

In the age of globalization when travel between countries is more convenient, we will find a surge of personnel working in organizations of many nations come to work together. Thailand is another country with many foreign workers most of which are migrant workers from 3 neighboring countries – Myanmar, Laos, and Cambodia. Myanmar workers account for 60 percent of all of them. This results from the registration of foreign workers under cabinet resolution. On 23 February 2016, it was found that the total of 1,067,410 foreign workers report to apply for a work permit with 22,807 dependents. The total of foreign workers consists of 639,464 Myanmar workers, 365,542 Cambodian workers, and 62,404 Lao workers [2]

Generally migrant workers who come to work in Thailand are working as labors or working in labor intensive businesses. The arrival of migrant workers from neighboring countries, especially from Myanmar, has both good and bad impacts on Thailand. Most of good impacts are on employers who can have migrant workers replace Thai workers in fields with labor shortage. These foreign workers can be employed relatively cheaper too. Foreign workers are a phenomenon of cultural globalization that possesses five important features (1) it is an international phenomenon because it causes people to travel from one country to another country, to move from one economic and social system to another system by employment. (2) Foreign workers are actually a circulation of working population from a country with agriculture-based economy to another country whose economy primarily relies on industrial and service sections, and from a poorer country to another richer country. (3) Poverty and the need of life opportunities are still important impetus for the movement of foreign workers. Working population, whether labors or house workers, are struggling to earn money to send back to support

\* Corresponding author; e-mail: mbakru1@gmail.com

their families. Foreign currencies not only help the families of individual workers, they also nourish the country's economy. (4) Problems about foreign workers have become more complex and diverse, they result in problems on politics and international relations, problems on society and culture, as well as public health problems. (5) Foreign workers are a phenomenon which reflects that the international society in the modern world has more economical, political, cultural connection and more communications. [3]

As for Kasemchai Farm Group Co., Ltd., the company is running business about livestock, fishery, and food processing. The company has a policy to develop good quality products with safety and legitimacy for customer satisfaction. [4] The company employs a large number of foreign workers, especially Myanmar workers who had to travel to work in Thailand whose cultural context is different from their homeland. Nowadays the company executives have to provide incentives and create motivation for the Myanmar workers so that they do their best in working. It is quite difficult to motivate these Myanmar workers who have different demands and sentiments to work together. The motivation has to be utilized properly to optimize it. So, the study of motivation for the Myanmar workers in Kasemchai Farm Group will show important factors that are useful to the company management. It will allow the executives to know the crucial things to make the Myanmar workers satisfy with their working. If the company can fulfill their needs, they will be willing to do their best which will help the company to perform effectively and be able to achieve its objectives. This will result in better livings in our society. With the above reasons, the researchers is interested to study about the work motivation of the Myanmar workers in Kasemchai Farm Group to come up with a method that can encourage the Myanmar workers to perform with their full capacity. The study will be of use to the human resource management of Kasemchai Farm Group, and other companies with Myanmar workers will be able to use it as a case study.

## 2. Objectives

2.1. To study work motivation of Myanmar workers in the factory of Kasemchai Farm Group Co., Ltd.

2.2. To compare work motivation of Myanmar workers in the factory of Kasemchai Farm Group Co., Ltd. by personal factors.

## Literature Review

Preeda Phromphet [5] proposed that a successful management requires not only executives' ability to manage various resources, but also the ability to motivate personnel in the organization to work effectively, to achieve objectives of the organization. The researchers had reviewed literatures and case studies to create framework by the following concepts.

### 1. Work Motivation Concepts

Budsara Tiaronbunjong [6] gave the meaning of work motivation as incentives or stimuli for each individual's working behavior which allow that individual to work with determination, willingness, and satisfaction in order to achieve organization goals. Ratre Pattanarangsarn [7] commented that motivation is a condition or component which induces a person to show his behavior purposefully in order to meet his own goal or the goal that the motivator has set. Surang Kowtrakul [8] said that motivation means a component that stimulates purposeful behavior.

Siriwan Serirat, *et al.* [1] explained the importance of Components of Performance which consist of Ability, Environment, and Motivation. If a capable employee gets supported by an organizational environment and has sufficient incentives, he or she can achieve a good goal. If one of the components is absent, his or her work will have problem. In case personnel lack knowledge and capability, executives can develop their skills through training and coaching, or improving working environment. But if personnel have motivation problem, it will be more difficult for executives to solve the problem because person's behavior is a complex phenomenon. Executives may not be able to analyze why personnel are not motivated and how to change their behavior. These are challenging issues. Executives need to see the importance of motivations that affects performance.

### 2. Work motivation Theories

Nara Somprasong [9] mentioned Frederick Herzberg's two-factor theory. This theory explains that there are certain factors in the workplace that cause job satisfaction, while a separate set of factors cause dissatisfaction. The two-factor theory developed from data collected by Herzberg from interviews with 203 engineers and accountants in the Pittsburgh area to find factors that lead to working satisfaction as well as factors that lead to working dissatisfaction. Herzberg found that the factors causing job satisfaction (and presumably motivation) were different from those causing job dissatisfaction. The two feelings cannot simply be treated as opposites of one another. The opposite of satisfaction is not dissatisfaction, but rather, no satisfaction. Similarly, the opposite of dissatisfaction is no dissatisfaction.

Herzberg classified these job factors into two independent categories :

1. Motivation Factor – Working environment that satisfy and motivate a person in his working. It consists of Achievement, Recognition, The Work Itself, Responsibility, and Advancement.

1.1 Achievement – When a personnel is able to finish his or her work, to be successful, to solve problems, to prevent future problems, then he or she will be satisfactory and pleased with the success.

1.2 Recognition – Being recognized by superiors and colleagues. Recognition may be in the form of praise, congratulation, encouragement or any other expressions that indicate acceptance of ability. When a personnel achieves one goal, recognition is latent with the success.

1.3 The Work Itself – An interesting work, a challenging work that requires initiative and creativity.

1.4 Responsibility – Satisfaction caused by being assigned to new tasks and having full power in working, no close monitoring or control.

1.5 Advancement – Getting promoted, having opportunities to study further or training.

2. Maintenance or Hygiene Factors – The factors that maintain work motivation of a personnel. If they are absent or present but inconsistent with the personnel, he or she will come to dislike his or her work. The factors are external.

2.1 Salary – Salary and salary increase are satisfactory to the personnel.

2.2 Possibility of Growth – Personnel get promotion in their organizations, and have opportunities to improve their skill.

2.3 Interpersonal Relation between Superior, Subordinate and Peers – Communications with good words and gestures that indicate good relationship, cooperation, and understanding of each other.

2.4 Status – Careers that are recognized by society, honorable, and dignified.

2.5 Company Policy and Administration – Companies’ administration and internal communications.

2.6 Working Conditions – Physical conditions of works such as brightness, noise, air, working hours, including other environmental features like tools and utensils.

2.7 Personal life – Good or bad feelings that are caused by a personnel’s work. For example, if a personnel is moved to a new workplace which is far away from his or her family, he or she will be unhappy and dissatisfactory with work in the new place.

2.8 Security – A personnel’s attitude toward the stability of his or her work, durability of his or her career, or firmness of his or her organization.

2.9 Supervision-Technical – An executive’s ability to manage, justice in administration [10]

From the above, it can be concluded that motivation factors are necessary to make personnel satisfactory and love their works. However, motivation factors need to be maintained because if they are decreased lower than personnel’s level of acceptance, the personnel will become dissatisfactory. Working satisfaction of personnel is a feeling that positively affects performance. It leads to personnel’s happiness in their working life, enthusiasm, determination and morale. All of these contribute to the overall working capability and target achievement of an organization.

We use the literature review results to developed this research framework.

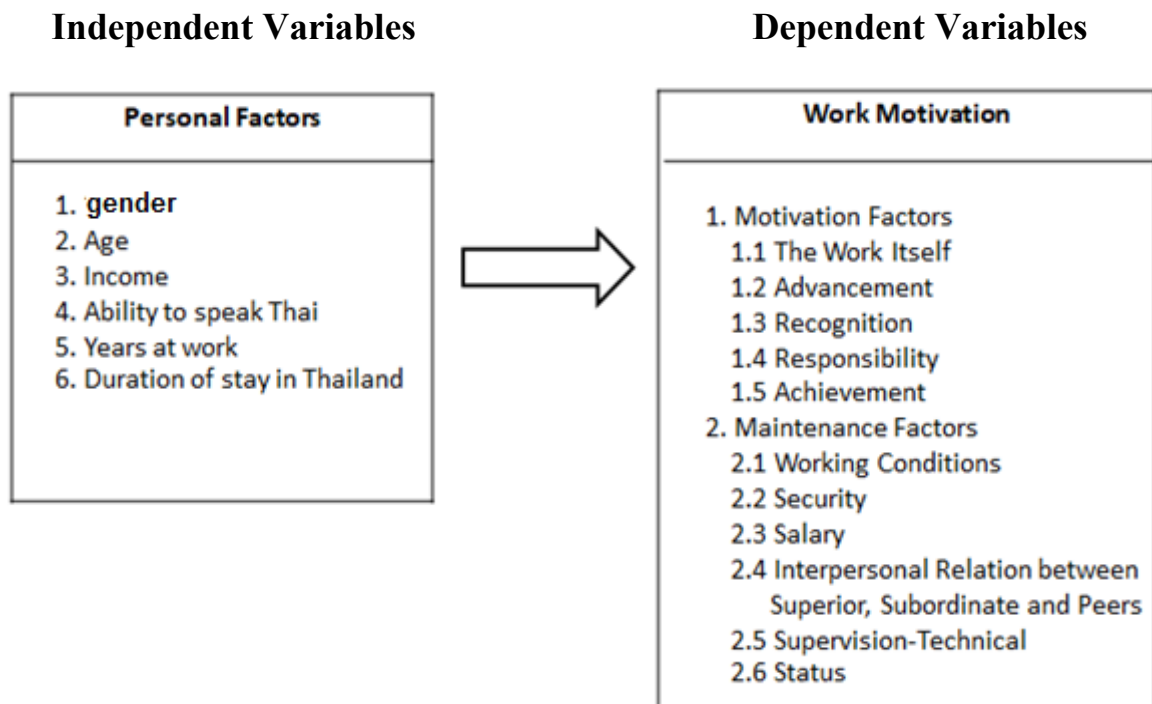


Figure 1 Research Framework



### 3. Methods

The study of Work Motivation of Myanmar Workers in Food Processing Factory: Case Study of Kasemchai Farm Group Co., Ltd. is a quantitative research. The population from which the data are collected is 150 Myanmar workers of Kasemchai Farm Group. Samples used in this research are 108 Myanmar workers of Kasemchai Farm Group. The sample size is calculated from Krejcie and Morgan's [11] formula with +/- 5% sampling error. The 108 samples are taken using simple random sampling method.

**Research tool:** Questionnaires were used for collecting data; designed with concepts, theories, and related studies, as well as a research framework with steps of questionnaire construction. The detail contents of the questionnaire are consisted of two parts as below.

Part 1: Questions about the personal factors of the respondents which include gender, age, ability to speak Thai, years at work, income per month, duration of stay in Thailand. These questions are on checklist.

Part 2: Questions about factors that affect work motivation. The factors consist of motivation factors and maintenance factors.

The motivation factors are Achievement, Recognition, The Work Itself, Responsibility, Advancement. There are 13 questions regarding the motivation factors.

The maintenance factors are Supervision-Technical, Interpersonal Relation with Supervisor and Peers, Working Conditions, Salary, Job Security and Work Position. There are 14 questions regarding the maintenance factors.

**Assessment of Questionnaire** – The questionnaire draft was assessed content validity at the discretion of 3 experts. Checking comprehensiveness of all determined aspects and evaluating the congruence between each question and the terminology. After that, the questionnaire was taken to a language expert who translated it from Thai into Myanmar. And then the Myanmar questionnaire was translated into Thai by another language expert, to examined consistency with the Thai original.

### 4. Results and discussion

The data analysis was conducted using statistical packages. Descriptive Statistics analyses including the percentage of the respondents' personal characteristics, mean, and standard deviation (SD) in the descriptive statistics.

In inferential statistics, the hypothesis testing is based on independent t-test and one-way analysis of variance (ANOVA). In cases where the difference was statistically significant, they were accounted for multiple comparisons and tested using Least Significant Differences: LSD test.

#### Part 1 Personal characteristics of the respondents

The study found that the respondents are equally female and male, 54 respondents (50%) for each gender. The majority of the respondents are aged between 20-28 years with 57 workers (47.20%). There are 79 workers (73.10%) who can speak Thai. While the majority of respondents have years at work between 1-3 years with 68 workers (63.00%), and 73 workers (67.60%) have monthly income of 7,001-9,000 Baht. Most of them has been in Thailand for 2-3 years, 66 workers (66.10%), respectively.

#### Part 2 Analyses Results of work motivation of Myanmar Workers in the factory of Kasemchai Farm Group Co., Ltd.

**Table 1 Analyses Results of work motivation of Myanmar Workers the factory of Kasemchai Farm Group Co., Ltd.**

Work Motivation of Myanmar Workers	$\bar{x}$	S.D.	ranking
Achievement	3.53	0.32	11
Recognition	3.64	0.31	10
The Work Itself	3.64	0.37	9
Responsibility	3.70	0.33	4
Advancement	3.67	0.31	6
Supervision-Technical	3.78	0.31	1
Interpersonal Relation	3.65	0.34	8
Working Conditions	3.68	0.36	5
Salary	3.75	0.33	2
Security	3.66	0.41	7
Work Position	3.71	0.36	3
<b>Overall</b>	<b>3.66</b>	<b>0.19</b>	

The results show that the overall of work motivation of the Myanmar workers in the Kasemchai Farm Group factory was at a high level (Mean = 3.66). The first three most important factors are: supervisors (Mean = 3.78), salary (Mean = 3.75), and work position (Mean = 3.71) respectively.

### Part 3 Hypothesis Testing

The research results are summarized in Table 2 as follows:

**Table 2 Comparison of personal factors affecting the work motivation of Myanmar workers in the factory of Kasemchai Farm Group**

Dependent Variables	Independent Variables					
	Gender	Age	Income	Speak Thai	Years at Work	Duration
<i>statistics</i>	<i>t-test</i>	<i>ANOVA</i>	<i>ANOVA</i>	<i>t-test</i>	<i>ANOVA</i>	<i>ANOVA</i>
Achievement	0.22	0.28	0.70	0.12	<0.01**	0.95
Recognition	<0.01**	0.54	0.28	0.46	0.59	0.31
The Work Itself	0.95	0.19	0.57	0.55	0.01**	0.09
Responsibility	0.02*	0.66	0.88	0.21	0.02*	0.66
Advancement	0.42	0.20	0.56	0.01**	<0.01**	0.19
Supervision-Technical	0.87	0.20	0.43	0.88	0.11	0.73
Interpersonal Relation	0.38	0.33	0.65	0.45	0.21	0.02*
Working Conditions	0.37	0.13	0.46	0.08	<0.01**	0.06
Salary	<0.01**	0.55	0.28	0.66	0.57	0.66
Security	0.91	0.33	0.72	0.18	0.03*	0.28
Work Position	0.95	0.14	0.07	0.11	0.10	0.12
<b>Overall</b>	<b>0.95</b>	<b>0.67</b>	<b>0.96</b>	<b>0.11</b>	<b>&lt;0.01**</b>	<b>0.46</b>

P-value

The results show that the overall work motivation for Myanmar workers is based on years at work. Having longer working years will be more motivated to work at statistical significance at the 0.01 level. When considering independent variables, it was found that (1) Myanmar workers with different gender had different motivation to work in recognition, responsibility and salary. Females assessed first 2 factors higher than males. (2) There is no difference in the motives of Myanmar workers at different ages. (3) There is no difference in the motives of Myanmar workers with different income. (4) The ability to speak Thai will affect the factor in advancement at the 0.01 level of significance. The more Myanmar workers are able to speak Thai, the more advanced their work is. (5) Years at work is the most important factor affecting work motivation. The results show that the longer working years, the more likely it is to assess higher in more number of motivation factors. It has effect on the achievement, responsibility, advancement, work conditions and security. (6) The duration of stay in Thailand of Myanmar workers in the Kasemchai Farm Group factory has statistically significant influence on motivation factor in relationship between superiors and colleagues. Those who have been in Thailand for a longer period, the higher the rating will be.

## 5. Conclusions

### 5.1 Considerations

The research found that overall the work motivation of Myanmar workers in factory of Kasemchai Farm Co., Ltd. is at a high level. The top 3 most important drivers of the motivation are supervision, salary and work position. The findings align with Sirin Suriyawongse's [12] research in 2005 regarding motivation in the performance of Botanical Garden Organization's personnel. The research found that work motivation was at a high level. The top 3 most important drivers of the motivation are salary, supervision and work position.

The research also found that overall work motivation of Myanmar workers is mainly driven by number of years at work. The finding aligns with the research of Preeda Phromphet [5] regarding working incentive factors of migrant workers in Siam International Food Factory, Amphoe Chana, Songkhla Province, Thailand. However, it contradicts to the research of Pissamai Sarakran [3] stating that acceptance of co-workers strongly correlated with work motivation of Myanmar workers in Bangkok with significant level of .01.

### 5.2 Recommendation for Further Application

1. Years at work are the key factor to enhance work motivation for Myanmar workers in Kasemchai Farm Group's factory in both general and by factor study. Therefore, efforts to retain such workers in the organization will help reinforce atmosphere in the workplace and improve work motivation. Management should focus on retaining these workers to stay in the organization longer since it will improve overall performance of the organization.

2. Gender is the next key factor to enhance work motivation for Myanmar workers in Kasemchai Farm Group's factory. Women tend to focus on recognition and responsibility more than men. Men tend to focus on salary more than women. If management realizes the different preference of each individual, it will help them to have a clearer direction in determining the plan to encourage work motivation.

### 5.3 Recommendations for Next Research

1. This research was done specifically on Myanmar workers in Kasemchai Farm Group's factory, which may have a different context from other companies. Therefore, the interested researchers can adopt this framework to work on a comparative study on other environments.

2. This research is quantitative research. The interested researchers can apply for qualitative or mixed-method research to obtain more in-depth information.

3. The findings focus on migrant workers from Myanmar. The interested researchers can apply this framework to study with Lao, Vietnam or Cambodian migrant workers, the majority of workers in Thailand, either holistically or in a comparative way to obtain a clearer view on this subject.

### References

- [1] Siriwan Sereerat et al. **Organization and Management**. Bangkok: Visit-Pattana. (in Thai).1999.
- [2] Bangkok Biz News. **Migrant workers exceed 1.1 million**. Retrieved June 26, 2017, from <http://www.bangkokbiznews.com/news/detail/710429> (in Thai).2017.
- [3] Pissamai Sarakran. **Acceptance Of Co-worker And Satisfaction With Compensation Predicting Work Motivation Of Myanmar Labors In Bangkok**. Thesis, M.A. (Psychology). King Mongkut's University of Technology North Bangkok. (in Thai).2015.
- [4] Kasemchai Farm Group. **About KCF Kasemchai Farm**. Retrieved April 14, 2017, from <http://www.kcf.co.th/about.php> (in Thai).2017.
- [5] Preeda Phromphet. **Working Incentive Factors of Migrant Workers in Siam International Food Factory, Amphoe Chana, Songkhla Province, Thailand**. Graduate Research in Human Resources Management of Education. Thaksin University. (in Thai).2012.
- [6] Budsara Tiaronbunjong. **Motivation Affecting The Morale of Nurses at Singburi Hospital**. Master Project, M.B.A. (Management). Srinakharinwirot University. (in Thai).2003.
- [7] Ratee Pattanarangsana. **Human Behavior and Self Development**. Faculty of Education. Rajabhat Institute Chandrakasem. (in Thai).2001.
- [8] Surang Kowtrakul. **Educational Psychology**. Bangkok: Chulalongkorn University. (in Thai).2001.
- [9] Nara Somprasong. **"Motivation" in Theory and Practice in Educational Administration Unit 6**. School of Educational Studies. Sukhothai Thammathirat Open University. (in Thai).2001.
- [10] Tietjen, M.A. and Myers, R. M. "Motivation and job satisfaction", **Management Decision**, 1998. 36(4), :226-231
- [11] Krejcie, R.V. and Morgan, D.W. Determining Sample Size for Research Activities. **Educational and Psychological Measurement**, 1970. 30, 607-610.
- [12] Sirin Suriyawongse. **Motivation in the Performance of Botanical Garden Organization's Personnel**. Independent Study. Faculty of Political Science and Public Administration. Chiang Mai: Chiang Mai University. (in Thai).2005.

# The philosophy of sufficiency economy to happiness in the work of the staff in Bangkok

Wisit Rittiboonchai<sup>1,\*</sup>

<sup>1</sup>Faculty of Management Science, Nakhon Pathom Rajabhat University

## Abstract

This research aims to study 1. the introduction of sufficiency economy philosophy implemented in Bangkok. 2. Happiness in the work of the staff in Bangkok. 3. the influence of the philosophy of sufficiency economy affects happiness in the work of the staff in Bangkok. Researchers used quantitative research techniques from the employee number 406 people use multi stage sampling method Tools used in this research is the research questionnaire. Analysis of the data by frequency percentage average, standard deviation and regression analysis by using the structural equation model.

The results showed that: 1. the philosophy of Sufficiency Economy in Bangkok in the included in high level. The aspects have been evaluated in the first three sequences include conditions moral conditions of knowledge and immune in good 2. Happiness of the staff in Bangkok. In total, at a high level. The aspects have been evaluated in the first three sequences including virtue, learning and relaxation (Mean = 4.19) 3. Using the philosophy of sufficiency economy affects happiness in the work of staff in Bangkok Statistical significance ( $\gamma = 0.86$  SE = 0.06 t-value = 14.00) With the predictive power of 77 percent ( $R^2 = 0.77$ ).

**Keywords** : The philosophy of sufficiency economy , Happiness in the work, staff in Bangkok

## 1. Introduction

In the globalization of competition intensifying, as a result, humans must work to race against time to create and seek funds to fulfill the popular objects. This is the era of the tension of the people in the society especially people of working age in Bangkok. The capital of Thailand is rapidly expanding. In terms of population increase and expansion of the city. As a result of the creation and the development of communication network infrastructure. [1] Such issues directly impact on performance. And enhances the pleasure of the employees directly. The impact of external factors such as what can not be controlled. Because of changes to the competitive environment of the world. However, what can not it be caused by internal employees themselves. Happiness is important to work. As can be seen from Theory of Happiness From many theorists [2] [3] [4]

Considered a fortunate Thailand we have powerful Kings tribute to the King Bhumibol Adulyadej. He had already invented the philosophy of sufficiency economy up and eat this concept, to whom the whole world and Thailand nationals in order to create a way of living in a world where quality changes with three main hoop two such criteria have proven international as applicable until he actually received flees to tie the rewards offered to them in honor of Mr. Khofi Annan from The Secretary-General of the United Nations "success for the highest human development."

Research the matter of sufficiency economy philosophy to happiness in the work of the staff in Bangkok, researchers with the purpose to explore the use of the philosophy of sufficiency economy in the Group of employees including researching the influence of the philosophy of sufficiency economy that affects the pleasure to work or not. Because of the staff in Bangkok have been affected by the pressure and stressful situations. The researchers hypothesized that. If employees are adopting the philosophy of sufficiency economy will help deploy such pressure reduction. And a pleasure to work. The end result of such a joy to do an effective resource to work alongside quality of life. This will affect the development of the country.

## 2. Objectives

- 2.1. to study the philosophy of sufficiency economy principles implemented in Bangkok.
- 2.2. to study the happiness in the work of the staff in Bangkok.
- 2.3. to study the influence of the philosophy of sufficiency economy affects happiness in the work of the staff in Bangkok.

## The hypothesis in the study

The philosophy of sufficiency economy principles implemented affects happiness in the work of the staff in Bangkok.

---

\*Corresponding author; e-mail: mbakru1@gmail.com

## The documents and related Literature

Researchers have studied the relevant research to create a conceptual framework for research this strand of the literature review is divided as follows :

### Using the philosophy of sufficiency economy

Philosophy is the theory that the King had direct to existence and conduct of citizens at all levels, from the community level up to the level of the family, the State, both in development and management, in moderation, especially for economic development to continue the world Yu. Management is khalokawat his Majesty hath speeches entitled "sufficiency economy" when's birthday on 4 December 1997 [5] ,who welcomes the concept. The matter of sufficiency economy to comply with various agencies, but most people understand that Localism is the story of a farmer in the countryside, but the real, as well as other professionals, merchants, civil servants and employees, companies can apply enough economic speeches have, which subsequently has many scholars and organizations, the meaning of "sufficiency economy" added a variety of means. Pailoah Lerdwiram [6] discusses the meaning of localism that Localism is the philosophy of the mind and condition ourselves first. If it struck in the lustful passion From there, it's reasonable to remember keywords hold 3 words is his person said the word anchor Temperance and, there are immune.

Office of the National Education Commission [7] have discussed economic sufficiency that is capable of sustaining life as simple as there is estimated expenditure does not exceed their revenue recognized the shop at a local manufacturer. There is enough to eat, enough production to keep in the family. The remaining community from intake to be sold to a cooperative grouping so as to maintain their benefits and membership in the group.

Nattawut Bumrunjam [8] to study and codify the definition of sufficiency economy philosophy, conclude that the philosophy of sufficiency economy philosophy is the concept of life and conduct of the public at all levels from the family. Community level to State in self-development and management Families, communities and countries to act prudently to recognize self-sufficiency and do not destroy the environment. At the same time developing economies to globalization.

Sufficient means of sufficiently rationality, including the need to have an immune system well enough per to has any effect resulting from the change, both internal and external, will rely on the knowledge and caution. Leading academic programs used in the planning and execution of every step, and at the same time it must reinforce the fundamental mind of the people, in particular government officials, national. Theorists and students at all levels, business sense, moral integrity and providing appropriate knowledge. Life with patience. Perseverance, wisdom and prudence to consciously, balanced and ready to accommodate the rapid changes and extensive both on the social and cultural objects from the outside world as well.

Preyanuch phibunsarawat [9] Said the sufficiency economy used to affect the development that to understand the "conceptual framework" that is the philosophy that the existence of the guidelines and guidance and conduct themselves in a way that should be based on the traditional way of life of the society in Thailand. Can be applied at any time and see the world as a linear system that change over time? Focus on the perils and survived the crisis For stability and sustainable development. At the same time, it must be understood that the Localism features can be provided allowing application to practical implementation at all levels. By focusing on practice moderation and development party official steps.

### The concept and theory of happiness at work

The concept of happiness or happiness have academics studied a lot. In this research brief, and request the essence As follows:

Maethavee Domthammanupab [1] said happiness is what philosophers say, count as the highest good. Happy with the relationship with the social skills and intelligence over support from the family.

Watcharee Pumthong [10] discusses personal happiness, that means a healthy body, mind, and society. The social level of happiness section refers to a holistic social development that gives priority to the development of the social dimension culture, religion, coupled with the development of the country .

Wood and Wood [11] discusses the happiness that related close to life satisfaction The person feels happy, tend towards the belief that Life or living that is satisfied.

Diener *et al.* [12] discusses the happiness that is the satisfaction of two elements is satisfied in all of life, and satisfaction in things such as work, family, self-possession.

Lyubomirsky et al. [13] discuss 3 reasons element

1. Frequent Positive Affect
2. High Life Satisfaction
3. Infrequent Negative Affect

Diener *et al.* [12] proposed that the symbols of happiness the features that are associated with positive feelings and consists of 7 feature

1. Confidence, Optimism, and Self-Efficacy
2. Likeability and Positive Construal of Others
3. Sociability, Activity, and Energy

4. Prosaically Behavior
5. Immunity and Physical Well-Being
6. Effective Coping with Challenge and Stress
7. Originality and Flexibility

Manion [2] explain that the happiness at work means of learning which is the response from the creative action of their own. It will cause a good relationship at work. There is a feeling that the good work that has been assigned are diversion in working in the Organization of the next. Which explains the elements of happiness 4 areas:

1. Connections mean perceived fundamental cause relationship of personnel in the workplace. The staff worked together to work in society. What a good relationship with personnel at their work. Cooperate and help each other. Conversation talk friendly. The friendship between personnel working with various and feel happy. As well as the perception that among colleagues with love and best wishes to each other.

2. Love of the work means to feel loved and attached tightly cohesive with the work. Perceive that their mission in practice successfully. Be glad of what are the elements of the work, enthusiastic, happy to enjoy the performance and the desire to work with pleasure feel happy when work is proud of their responsibility in the job.

3. Work achievement means to acknowledge that their work goals defined by getting success in work has been assigned to work that is challenging, successful, independent work. Operation results in a positive way made to feel valuable in life occurs, take pride in developing and changing things in order to succeed, progress and make the organization development.

4. Recognition means to recognize that they are recognized and trusted by colleagues. Participants get to know the efforts regarding the tasks that have been performed and accepted by the supervisor in the performance get the great expectations and trust of colleagues. Exchanging experience with colleagues, as well as knowledge continuously.

Kjerulf [3] said that happiness at work means the feelings that occur within the mind of people who responded to the incident at work as follows.

1. a feeling of enjoyment and fun with the work performed.
2. Good work and pride ourselves with their actions.
3. work with good people.
4. acknowledge that their job action, it is important.
5. recognize that there are people who see value in their jobs.
6. responsibility for the work performed.
7. Feel the joy and happiness at work.
8. Feeling stimulation and extra power at work.

Iopener [4] said factors or elements of work happy, it consists of 5 main factors or 5Cs is contribution, conviction, culture, commitment, confidence these elements to reflect that people are happy with the work and to develop their potential and performance, reaching the highest point? By linking up with pride, trust and acceptance.

Quality of happiness evaluation of happiness from individual-level social indicators which are measurements from the level of satisfaction and expectations, assess the feelings of the people from living conditions. In addition to this, happiness also depends on an individual's experience of "happiness" and "satisfaction" thus plays an important role in the quality of life in individual level.

Thai Health Promotion Foundation [14] have defined a measure of human progress, called "happy 8" as follows:

1. Happy body is a strong physical and emotional health, caused by knowing life known to eat, sleep, the life is happy.
2. Happy heart is well known for the kindness, generosity, sharing appropriately recognize the role of each of the boss, parents, and things come to life.
3. Happy relax is relaxation to know what things in life.
4. Happy brain is to learn, to develop themselves and contribute to the professional to progress and stability in operation and ready to become a teacher to teach other people.
5. Happy soul is of modesty patch meant to shame and fear of bad deeds of their own, which is the primary virtue of the coexistence of people in society. And teamwork.
6. Happy money is ability to manage your income and expenses for themselves and their families, including well-known household accounting.
7. Happy family is to have a stable and loving family. The family is immune, and a great encouragement to face the future challenges.
8. Happy society is to love harmonious society courtesy of their working and social housing.

For all the research literature review can be used to create a conceptual framework are as follows:

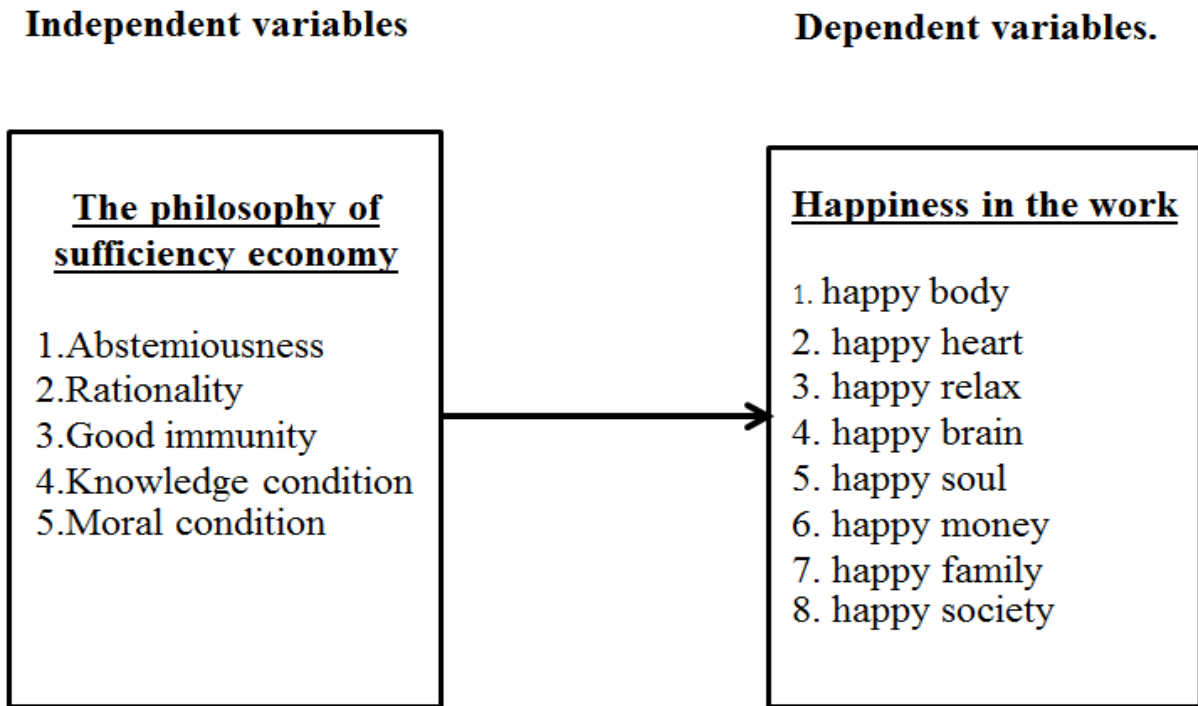


Figure 1 Conceptual framework for the research

### 3. Methods

This research is survey Research the working-age population of 5.293 million people in Bangkok. (Strategy and Evaluation Department [15] The researchers used a sample size formula of Krejcie and Morgan [16] on a sample of 406 people using multistage sampling starting from segments of the Bangkok District 50 to 6 groups according to the divisions of Bangkok Stratified random sampling Then, using simple random sampling. A separate group, select lottery 2 area of each group, set the quota to collect data on each region 87-88 patients by accidental sampling. When storing the amount of goals, and then terminate the storage. For the storage operation is as follows:

Table 1 population and sample storage

Group	The stored zone (zone 34 each)	
Center of Bangkok	Pomprapsattruphai	Ratchathewi
South of Bangkok	Suanluang	Yannawa *
North of Bangkok	Ladprao	Bangsur
East of Bangkok	BuengKum	Prawet
North of Thonburi	ThawiWattana	Chomthong*
South of Thonburi	Bangbon	Phasi Charoen

\* The field data collected by 33 people

The research is tested for content validity to consider the consistency between the content in question, an issue that must be researched to provide qualified people all 3 queries that quality checks from escrow, then. Only qualified and that update will generate a query and bring to try out with Employee in Nakhon Pathom province but not the number of samples 30 list value that information has value, confidence between 0.80-0.96 for questions about the sufficiency economy philosophy has values between 0.77-0.82 for the pleasure to work. The statistics include data analysis, data analysis, by finding the percentage frequencies of average standard deviation analysis and Simple Regression a structural equation (Structural Equation Modeling: SEM)

#### 4. Results and discussion

##### Personal Characteristics of the Respondents

The results showed that the majority of respondents were female (60.30 percent) aged between 31-40 years (36.50 percent), married (41.90 per cent) of the bachelor's degree level (41.90 percent). a staff position (77.80 percent) work experience of 5-10 years (30.80 percent).

**Table 2** using the philosophy of sufficiency economy in Bangkok

philosophy of sufficiency economy	Mean	SD.
1.Abstemiousness	4.03	0.63
2.Rationality	4.04	0.62
3.Good immunity	4.08	0.62
4.Knowledge condition	4.10	0.60
5.Moral condition	4.14	0.60
<b>Total</b>	<b>4.08</b>	<b>0.61</b>

Using the philosophy of sufficiency economy as a whole in Bangkok at a high level (Mean = 4.08) with a side that has been evaluated in three, including the first order. Moral conditions (Mean = 4.14) conditional knowledge (Mean = 4.10) and have a good immune (Mean = 4.08), respectively.

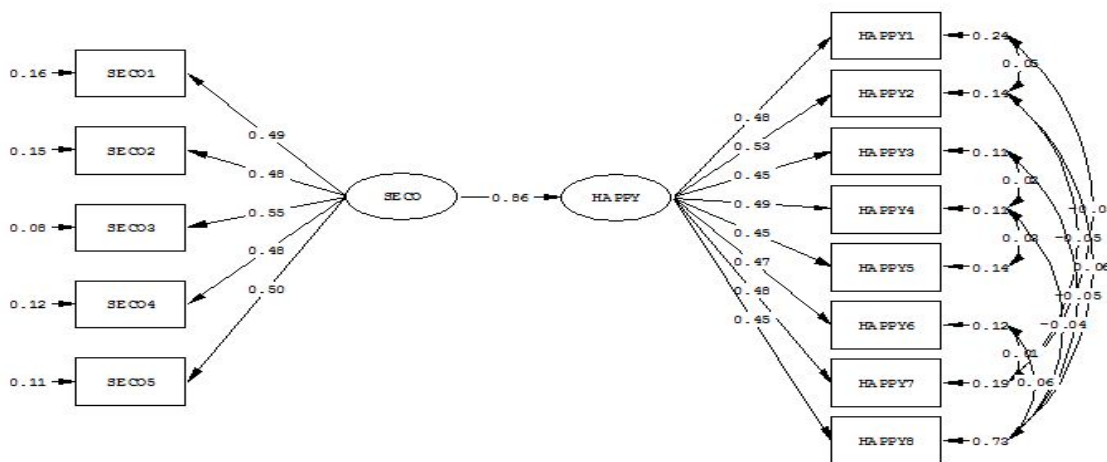
**Table 3** happiness in the work of the staff in Bangkok

Happiness at work	Mean	SD.
1. Happy body	4.11	0.69
2. Happy heart	4.04	0.64
3. Happy relax	4.19	0.55
4. Happy brain	4.22	0.58
5. Happy soul	4.23	0.59
6. Happy money	4.09	0.58
7. Happy family	4.13	0.65
8. Happy society	3.80	0.95
<b>Total</b>	<b>4.10</b>	<b>0.65</b>

Using the philosophy of sufficiency economy in Bangkok in an image is included on many levels (Mean = 4.10) by a side that has been evaluated in three priority include moral (Mean = 4.23) (Mean = 4.22) and relaxation (Mean = 4.19), respectively.

##### The results of the hypothesis test

Researchers estimate the parameters the results of such tests Statistics can be shown to structure relationships cause and effect the main philosophy for happiness in the workplace the staff in Bangkok in the overview below.



Chi-Square=93.31, df=54, P-value=0.06103, RMSEA=0.046

**Figure 2** The philosophy of sufficiency economy to happiness in the work of the staff in Bangkok



The research found that Using the philosophy of sufficiency economy affects happiness in the work of staff in Bangkok. Statistical significance ( $\gamma = 0.86$  SE = 0.06 t-value = 14.00) With the predictive power of 77 percent ( $R^2 = 0.77$ )

## 5. Conclusions

Research on The philosophy of sufficiency economy to happiness in the work of the staff in Bangkok to discussion results were as follows:

Using the philosophy of sufficiency economy affects happiness in the work of the staff in Bangkok. Statistically significant This brings the economic philosophy derived using inevitably affect the immune system in life Consistent with the concept Pailoah Lerdwiram [6] Proposed that a "sufficiency economy philosophy that helps the mind and condition of the operator lowers the lustful passion and create a reasonable result by bonding the word Temperance. And, there are immune. By the results from an analysis by structural equation to find that all the elements of the philosophy of sufficiency economy significantly. As well as the elements of happiness in the work. This is to prove that if employees in Bangkok have adopted such a concept in the works will inevitably create happiness in working effectively.

### Suggestions

#### 1. a suggestion to bring the research to use

1. Analysis of the use of The philosophy of sufficiency economy to happiness in the work of the staff in Bangkok Found to have evaluated all sides on many levels, but the sides have been evaluated in the two last ones include Temperance and rationality, where two such factors as the cornerstone in building a self-sufficient life. Therefore, the organization is said to adopt need to lay the groundwork for the first two factors are of special.

2. From the evaluation from the staff found happiness in the work of employees in Bangkok The good society have been evaluated in the sequence. So happiness at work need to consider the contexts in the society. The organization to build organization of happiness so employees need to realize happy relationship with surrounding social organization.

3. Structural equation analysis confirmed the influence of sufficiency economy to create a happy flavor and confirm that all the elements of composition is very important to the development of the twisters Who will bring sufficiency economy to create the happiness of employees in the organization must emphasize on this issue.

#### 2. Suggestions for the further research

1. Studies such as studies of transverse section in this particular moment, only people who are interested in repetition by time series study, it might be a different result.

2. In this study a case study in Bangkok. The sampling unit in the person also use random regardless of statistical chance. Thus the proposed extension boundary in education to suburbs and provinces. Try to adjust the sampling is concerned, including statistical chance in the process. It will make research reliability more.

## Reference

- [1] Methavee Udom Thammanupab **Human behavior and self-development** .Bangkok : SuanDusit Rajabhat University. (in Thai).2001.
- [2] Manion, J. Joy at work. Creating a positive workplace. **Journal of nursingadministration**, 2003. 33 (12), 652-655.
- [3] Kjerulf, A. **Praise for Happy Hour is 9 to 5**. Petersburg: Alexander.2007.
- [4] iOpener. **The science of happiness at work**. Retrieved 9 July 2015. From <http://www.iopener.com/the-science-of-happiness.2004>.
- [5] Chaipattana Foundation. **Sufficiency economy and new theory**.Date search 10 November 2016 .Form <http://www.chaipat.or.th/chaipat/index.php/th/publication/sufficiency-economy> (in Thai).2013.
- [6] Pailoah Lerdwiram. **Sufficiency Economy**.Bangkok :Thaidaydotcom. (in Thai).2007.
- [7] Office of the National Education Commission. **Sufficiency economy**.Date search 10 November 2016. Form <http://www.thaiedresearch.org/result/result.php?id=3996>. (in Thai).2007.
- [8] Nattawut Bumrungjam **The philosophy of sufficiency economy to daily life of students of Economics undergraduateat Chiang Mai University**. Research Report, Faculty of Economics in Chiangmai University. (in Thai).2007.
- [9] Preyanuch Piboonsarawut..**The capital library, with the philosophy of sufficiency economy**. Bangkok : Printing Rungpeatch company. (in Thai).2008.
- [10] Watcharee Pumthong. The happiness of Thai people: the measure with what. **Journal of the economic and social**.2005. 42 (4): 30-35. (in Thai)
- [11] Wood, S. E., Wood, E. G. **The Essential World of Psychology**.(3rd ed.) MA: Allyn &Bacon.2000.

- [12] Diener, E. Subjective well-being. **Psychological Bulletin**, 2005.95 (3X, 542-575)
- [13] Lyubomirsky, S., Sheldon, K. M. and Schkade, D.. "Pursuing Happiness: The Architecture of Sustainable Change." **Review of General Psychology**. 2005. 9 (2): 111-131.
- [14] Thai Health Promotion Foundation..Happy work place. Date search 12 February 2016. Form <http://en.thaihealth.or.th/2009>.
- [15] Strategy and Evaluation Department. **Statistic Bangkok 2557**. Date search 12 February 2016. Form [http://www.bangkok.go.th/upload/user/00000130/Logo/statistic/stat2557\(thai\).pdf](http://www.bangkok.go.th/upload/user/00000130/Logo/statistic/stat2557(thai).pdf) (in Thai). 2016.
- [16] Krejcie, R.V. & Morgan, D.W. Determining Sample Size for Research Activities. **Education and Psychological Measurement**, 1970. 30(3), : 607-610.

# The marketing mix factors affecting selection credit of the government savings bank kui buri, Prachuap Khiri Khan province

Matinee Sudthum<sup>1</sup>, Hansa Klaychanpong<sup>1</sup>, Wisit Rittiboonchai<sup>1,\*</sup>

<sup>1</sup> Faculty of Management Science Nakhon Pathom Rajabhat University

## Abstract

This research aims to 1) The study of marketing mix factors affecting selection of the credit offered by the government savings bank kui buri, Prachuap Khiri Khan province 2) To compare the marketing mix factors affecting selection of the credit offered by the government savings bank kui buri, Prachuap Khiri Khan province classified according to personal factors.

The samples used in the study is that customers who use the service credit by the government saving bank Kui Buri, Prachuap khiri khan province . Derived from a sampling of 400 persons, by means of random sampling chance. The tools used in this research include statistics used in data analysis were percentage, mean, standard deviation test and t-test and one-way analysis of variance.

The results 1)The marketing mix factors affecting selection credit of the government saving bank kui buri , Prachuap kiri khan province overall, the highest level. Considering it was found that the average in the first three, including personnel, physical environment. And the product, respectively.2) To compare the marketing mix factors effect to the credit of Government saving bank Kui Buri, Prachuap Khiri Khan province classified according to personal factors found that users with sex, age, income, use different affecting factors of marketing mix in the overall credit are different. The users level of education and occupation on the use of different marketing mix in the selection of credit service overall there was no significant difference in the 0.05.

**Keywords :** Marketing mix, Credit, Government saving bank

## 1. Introduction

In brokering business growth an expansion in the business sector. The money is important factor that helps sustain such growth. The loan has a role inevitably have to do business for the purpose of the loan is based. The goal of the application and the ability to repay the loan within the agreed deadlines. (Depending on the type of loan that happens), the growth of bank lending in the current inevitably to compete fiercely. The primary goal of taking market share in the individual clients, whether they are personal loans. Mortgage and credit cards ,etc.

The credit services can make the life of the loan is better than ever. The supply of goods and services used to meet the requirements can quickly and conveniently and catch up with particular requirements necessary goods and high cost, such as land and house, and sports facilities in everyday life, etc. in addition, credit also eliminates the troubles in time is necessary. Such a sudden illness, or in case of an emergency. Almost all income from financial credit business is the main income from the financial institutions responsible for saving money from those who have money left saving silver and lead such from circulating to savers with interest rate from borrowers.

The government saving bank is a trusted source of savings is the most important country to help support the government in different policy actions on a national level. At present, the Bank added a service business all service credit deposits to various aspects of financial services for the public. The implementation of individualized social support, including from the Government extended the loan towards citizens. There is both a credit to small business loans for housing loan project, the people's bank loan credit and welfare for many others.

During this period, the bank has changed. Improve operation system and service in all aspects, the bank has to adapt to the situation. In order to maintain the customer base of more than 26 million accounts by mobilizing resources in all aspects. Preparation to improve the appearance and style of advanced services and comprehensive. To support the service to meet the needs and covers all groups and professional all ages. The bank aims to continue to meet the needs of the stakeholders of the bank that matters. Including customers, people government (Ministry of Finance) and employees by providing financial services thoroughly, especially, the foundations of the country. Promote the saving and investment. To strengthen at the community level. And the base is in promote the country's sustainable development. [1]

---

\*Corresponding author; e-mail: jassiga\_k@hotmail.com

The Government Savings Bank has a primary goal in operation is to expand the customer base of business credit and increase credit markets, including a number of ventures that is accepted and can compete job Bank is a service business in the service industry is considered there is a difference from the business to complement industrial consumer goods and general consumer products because there are both tangible and intangible products are goods and services that offer per customer or market. The marketing strategy that is applied to the service business will need to provide your marketing mix, different from marketing in General, especially those who are hospitality, doing business as public [2], marketing mix, a concept for a business service (Service Marketing Mix) is a concept related to the business, which is a different business, general consumer goods success in business.

Kui Buri district is a district with a focus in the tourist attractions of Prachuap Khiri Khan province. Although the population, only 40,195 people. But the main tourist attraction to 11 [3] with the growth of the tourism business The growth of population and income resulted in the intense competition of the credits. Research on the marketing mix factors affecting the use of the credit service of the government savings bank Kui Buri, Prachuap Khiri Khan province. Arise from the attention of the resulting from the internship and noticed the competitive circumstance mentioned. The aim is to guide the development and improvement of quality of service on credit. The study focuses on the marketing mix and 7 aspects such as product, price, distribution, promotion, marketing. Individual, the physical environment and the service process. The study results can be applied as data for planning the differentiation strategy in products achieve competitive advantage and the development of marketing credit of bank efficiency better.

## 2. Objectives

2.1. The study of marketing mix factors affecting selection of the credit offered by the government savings bank kui buri, Prachuap Khiri Khan province

2.2. To compare the marketing mix factors affecting selection of the credit offered by the government savings bank kui buri, Prachuap Khiri Khan province classified according to personal factors.

### The hypothesis in the study

The marketing mix factors affecting selection of the credit offered by the government savings bank kui buri, Prachuap Khiri Khan province classified according to personal factors.

### The documents and related literature

Researchers have studies the relevant research to create a conceptual framework for research this strand of the literature review is divided as follows :

#### The concept and the theory about the marketing mix factors

Siriwan Sereerat [4] discusses the concept and theory of the market. The marketing strategies for service business use of the marketing mix (Marketing Mix or 4Ps) as well as the goods, which consists of the product price Place and promotion and the characteristic of service that has difference from goods many scholars therefore that should rely on the more 3 P 's which consists of individuals (People) or employees. Create and physical evidence presentation and process include variable marketing 7 reasons.

Chaisompol chaoprasert [5] Marketing mix means the marketing variables controlled, which the company used together to satisfy its target audience of the following tools.

1. Products refers to that offered by the business to meet the needs of The customers to the satisfaction of products offered for sale may exist or not. The product can make customer service has been the difference from competitors. And as an added value in the attitude of consumers.

2. Price means the value of the product in the form of money, such as interest rates, various fees that banks charge, etc., price is a factor causing income. Importance of perception in the value of the services offered on perceived quality. And has the effects of the image of the service. The price will determine how depending on the target customers and competition. Pricing must comply with other marketing strategies decision making the price depends on the factors both inside and outside the organization, such as the goals of the organization. The state competition, market positioning, the elasticity of demand etc.

3. Promotion to communicate information between sellers and buyers to create attitudes and buying behavior. Communications may salesman sold (personal selling) and communicating with the media. (Non-personal selling) in contact. Communication Many may choose to use one or several of the tools. This includes advertising sales by personal selling promotions providing news and Public relation, direct marketing .

4. Place refers to the structure of the channel, which consists of institutions and activities. Used to move products and services of the organization to the market as the bank's location, cleanliness and beauty of the place, parking, etc., since the service is not retained. Production and consumption occur simultaneously. So therefore related to atmospheric environmental service offerings to customers. Influence customers' perception of the value and benefits of the service offered.

5. People means the employee service provider must have the knowledge, abilities and skills in the service, good attitude, can meet the needs of customers. From the specific characteristics of the service.

6. Process means the procedure, regulation, or how to work involves the creation and presentation of services to customers. The process of the service, to deliver. The quality of service to consumers and quickly impressed customers such as the approval of credit facility to pay the price.

7. Physical Evidence (physical environments) include the building of a business service tools and equipment such as computers. ATM machine. Desks decorated lobby, parking lot, Garden decoration, bathroom signage various forms of these things is something that the customer uses to represent the quality of service, that is, customers are relying on the physical environment is one of the factors in choosing the.

#### **The concept and the theory about the service**

Siriwan Sereerat [4] discusses service quality is important. One thing to create the difference of the business. The business services to win the competition, it must have a delivery service with high quality continuously, rather than competitors, customers in the past. Tell others about the advertising business and service. After the customer has to compare the customer service that customers have to service customers expect. If the customer service has been lower than the services that customers expect. Customers are the lack of interest in the carrier. But if the service clients receive equals or exceeds customer expectations. Customers will often use services from the service provider.

Chaisompol chaoprasert [5] discusses service means the process of delivering a product that did not exist (Intangible Good) of business with the client. In its absence, it must meet the needs of clients that leads to satisfaction.

Kotler [6] services have characteristics different from selling goods or products in general. When dealing with the business. Important characteristics of the service are as follows.

1. The essence of trust (Trust) service activities or actions performed recipient provider service as the service process occurs. The buyer or the client can't know in advance how to be treated until the activity service will happen. The purchasing decision thus depends on the trust. Unlike buying general merchandise that consumers can grab catch check the goods before deciding to buy it. The service can provide the customer will receive the quality guarantee. Or reference experience that others have used the services.

2. Intangibility the service features and intangible things could not touch prior to purchasing occurs, i.e., the buyers or customers may not know in advance, or before you decide to buy services like to buy general goods. Besides buying service is intangible only live comment purchase attitude and experience the original has been purchasing such decision The buyer may determine the criteria about the quality or benefit of services they should get. Then decided to buy services meet such requirements.

3. The split apart not (Inseparability) the services were not be separated from the person or equipment that a service or service supplier. Production and consumption of services will occur at the same time or close to the sales services. Unlike the product with production. Sale of goods was consuming later. Also, the service could be divided components in itself apart. As the production of general merchandise. The carrier is the seller services directly to consumers. This process happens continuously since the start of service until you are so service ends. The consumer will participate in the service process at that time. By acting as a service recipients from the carrier at the same time.

4. Different styles are not fixed (Heterogeneity) the services were not fixed and unable to determine exact standards. Because each depends on the service provider each. The method provided is characteristic of self although the service is the same. From the same provider but different agenda. The quality of services may be different. Depending on the provider, the service time of service and service environment while being different.

5. The characteristics that cannot be preserved (Perish Ability) the services have characteristics that cannot be maintained or reserved like general goods . when there is no demand for services will be wasted not called back take advantage again. The services are the loss is relatively high.

6. The characteristics that cannot be possessive (Non-Ownership) the service has the characteristics of no ownership when buying service occurred. Unlike buying goods general obviously. Because when the buyer paid for any item will be permanently the goods immediately. While the buyer to pay any service The buyer will be in terms of service to each category. Because of the waiter is not a thing but is an activity or process of action.

Smith shatnakorn [7] discusses to the concept of service and its service. The service is to assist or operation for the benefit of others must have main hold practice. Not that the help. Useful to others will follow our mind. Who is the leading provider of generally. Principles of service with caution as follows.

1. According to meet the needs of the service. Services need to consider the main. To the needs of clients as the requirements in the service even if it is to help, we saw that it was good. And appropriate to the client how much. But if the don't care not the importance. The services that may be worthless.

2. Clients satisfaction, quality is customer satisfaction is the fundamental. Therefore the services must aim to clients satisfaction. And it is the key to service evaluation. No matter what we intend to serve how many But it is only in quantity, but the value of measured with service to satisfy our customers.

3. Treated by completely correct, complete, a service which can meet the requirement. The satisfaction of service recipients apparently is a practice that must be checked the correctness and integrity for the cup. If an error group and difficult to keep the customer satisfied. Despite the apology. Unfortunately, received only mercy.

4. Suitable for the situation of quick service delivery or service on time is important. The delay in determining makes the service does not comply with the situation. In addition to deliver goods on time. Will also need to consider the rush of customers. Respond quickly and early.

**Guideline for the management of credit**

Daranee Phutwiboon [8] discusses the credit management will be covered. Since the loan until the debt collection, 2 style that is the main task of management of credit. To be taken concurrently scales, that is, if a virtual any slack job must be strict, so that the credit management went well. For the development of credit management are as follows.

1. Credit Management The management subsidiaries under the administration of a specific business. You need to take into account the main goal of the business before. Target of Credit Management. Which should be consistent with the main goals of the business. It is the nature of the policy practices are as follows:

1.1 sales costs and a reasonable profit for the enterprise

1.2 Accounts Receivable control both the quantity and quality. To venture investment The debtor too Impair the prospects for increased sales.

1.3 Cost Control in loans. And debt collection costs, including bad debts on wages and salaries for the rental of premises, etc.

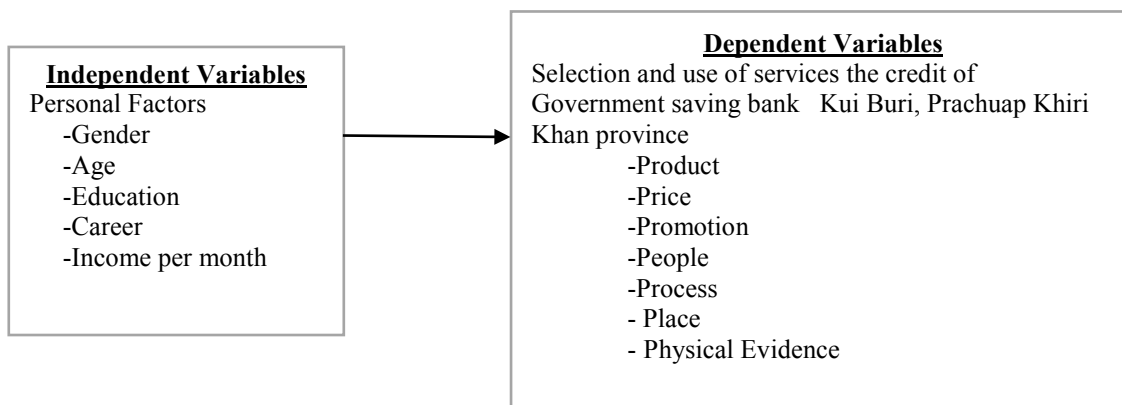
2. Credit management should take into consideration the cooperation and coordination with other parties of the company, such as sales or accounting department.

3. Credit management is both a science and an art, that is, the worker must have a knowledge of science, various aspects of financial accounting services, credit, etc., also need to have the ability to use art scoreboards and experience to diagnose, order, which is the unique ability to manage. Credit, effective until the desired goals.

4. Credit management to be effective, should have the expertise to perform each step in the job credit goal setting planning and operational policies. The routing duties and distribution credit checking operation with the goal of training employees and credit.

5. credit management still needs to have the process management according to the principles of general management is planning ,organizing ,actuating and controlling.

Results from a literature review can be summarized as a conceptual framework are as follows:



**Figure 1** framework in research

**3. Methods**

The population studied were the customers who use the services of credit by the government saving Bank Kui Buri, Prachuap Khiri Khan province total of 1,200 people (Credit the government saving Bank Kui Buri, Prachuap Khiri Khan province, 2016) was calculated using the formula of Taro Yamane [9] as a group. a sample of 300 cases, the researchers add a sample size of 100 samples were collected at 400 using accidental sampling. The survey tested The content validity (content validity) of 3 experts also tested the reliability with

Cronbach alpha values to customers is similar to the target population. But a sample of 30 such information for the confidence. It ranged from 0.70 to 0.91 The data were analyzed by percentage, mean deviation and t-test analysis and one-way analysis of variance.

#### 4. Results and discussion

##### Part 1 personal information of the respondents

Found that most of the respondents were male, were 51.25 majority 41-50 years is high 41.25 education mainly in primary level. The percentage of 29.25 mainly agriculture, were 37.50 majority, and 20,001 – 25,000 per month, the percentage of 40.50.

##### Part 2 Mean

The standard deviation and the significance of marketing mix factors affecting the selection of credit for the government saving Bank Kui Buri, Prachuap Khiri Khan province overview

The researcher used the Likert scale as the following.

**Table 1 The marketing mix factors affecting selection credit of the government saving bank kui buri , Prachuap kiri khan province**

The marketing mix factors	Mean	S.D.
1. Product	4.35	0.49
2. Price	4.12	0.75
3. Place	4.18	0.61
4. Promotion	4.14	0.63
5. People	4.44	0.53
6. Physical Evidence	4.40	0.52
7. Process	4.12	0.77
<b>Total</b>	<b>4.25</b>	<b>0.41</b>

The results showed that the level of importance of the marketing mix factors affecting selection of credit of the government savings bank Kui Buri Prachuap Khiri Khan province in total at the highest level. The factors are evaluated in the first three sequences include personnel, physical environment, and the products, respectively.

##### Part 3 Result to compare the marketing mix factors effect to the credit of Government saving bank Kui Buri, Prachuap Khiri Khan province classified according to personal factors.

**Table 2 The marketing mix factors effect to the credit of Government saving bank Kui Buri, Prachuap Khiri Khan province classified according to personal factors.**

The marketing mix factors	Gender	Age	Education	Career	Income
	<i>statistics</i>	<i>t-test</i>	<i>ANOVA</i>	<i>ANOVA</i>	<i>ANOVA</i>
1. Product	1.44-	0.32	1.04	1.79	0.35
2. Price	0.75	**4.47	5.83**	4.99**	0.22
3. Place	0.81	1.13	3.66**	3.27*	0.39
4. Promotion	1.34	0.10	4.63**	2.61*	0.11
5. People	0.41	1.38	3.78**	2.30	1.65
6. Physical Evidence	0.98	0.63	6.82**	4.64**	1.76
7. Process	0.70	*3.01	12.62**	9.82**	1.80
<b>Total</b>	<b>0.86</b>	<b>2.04</b>	<b>10.33**</b>	<b>7.91**</b>	<b>0.58</b>

**Statistical significance \* <0.05 \*\*< 0.01**

The research found that Users with different gender, age, income, affecting the marketing mix factors in choosing the loan as a whole did not differ. The service user is education and career as well as the factors affecting the marketing mix to opt for loans in overall difference was statistically significant at the 0.05 level.

#### 5. Conclusions

1. The marketing mix factors affecting selection credit of the government saving bank kui buri Prachuap kiri khan province in total at the highest level. And when the aspect that were at the highest level 3 sequence is personnel, physical environment, and the products. Which shows that the customer service of credit of the government savings bank Kui Buri, Prachuap Khiri Khan province The importance of service employees is important. According to the study results of Chayapar Bunmepipit [10] To study the behavior and marketing

mix factors affecting the decision to use credit services Housing Savings Bank bang khae of users The results indicated that, overall customer value marketing mix level when the found significance level to the highest level. The highest is in people.

2. To compare the marketing mix factors effect to the credit of Government saving bank Kui Buri, Prachuap Khiri Khan province classified according to personal factors found users with different gender, age, income, affecting the use of marketing mix in the overall credit are different .According to the study results of Warathip bunprawat [11] A study of marketing mix factors on choosing the people's Bank project loan of GSB tungtako, Chumphon . The research found that a comparison of the differences of the marketing mix, a people's Bank project of GSB. Classification based on personal factors, found that users of the service have different gender affects the use of the marketing mix, a factor in the decisions aggregate is not different.

### **Recommendation**

The results can be separated into two suggestions as follows.

#### **1. Recommendation on bringing the research to use**

1. The marketing mix affect the choice of the government savings bank will loan varies according to the level of education and occupation of the service by such factors, the government savings bank's executives need to study in detail the cause. To choose the type of loan, meets the needs of most customers. For the benefit of private clients and to enhance competitiveness.

2. The marketing mix factors that affect the choice of the Government Savings Bank loan has been evaluated in the light of those three, the first sequence in the service include personnel, physical and environmental aspects of products, we may conclude that the guidelines for creating a successful business providing credit service is a service that people want are undertaking the relationship with customers, knowledge, understanding and good service while the physical environment is important for its customers and the products are designed to meet the needs of most customers.

#### **2. Recommendation for the next research**

1. Such research focused on conducting quantitative evaluation of the demand side that is the side of the customers. If you want the profoundness of research. Focus should be on the supply side were the providers and administrators. The assessment 360 degrees. Or may be used in conducting a mix between quantitative and qualitative research in finding the answer.

2. With the limitations of the time by using the method the principles of probability. If those who are interested in sales work may be the research of the population. Or you may use the principle of random, the other way.

3. Such research a cross-section Do not study the continuous contact. So those who are interested to extend the research may make of such should be interesting results as well.

4. Interested parties may bring the conceptual framework in research were conducted with the government savings bank, or another bank to do research in comparison to extend the approach to knowledge creation wide more and more.

### **Reference**

- [1] The government savings bank. **History of The government savings bank**. <https://www.gsb.or.th/about-us/history-bank.aspx>. 21 February 2017. (in thai).2017.
- [2] Kotler, P. **According to Kotler: The World's Foremost Authority on Marketing Answers All Your Questions**. New York, NY: AMACOM.2005.
- [3] Thailand Information Center. **Kui buri**. <http://prachuapkhilikhan.kapook.com/> Kui buri).14 February 2017) (in thai).2017.
- [4] Siriwan Serirat **Modern marketing management**. Bangkok : Thammasarn Company . (in thai).2003.
- [5] Chaisompol Chaoprasert. **Marketing Service**. Bangkok : SE-ED U-Cation. (in thai).2004
- [6] Kotler, P. **Marketing Management**. (12<sup>th</sup> ed.). Upper Saddle river, NJ: Prentice-Hall.2003.
- [7] Smith Chatnukorn. **Hospitality and excellent service**. (2<sup>nd</sup> ed.) Bangkok: Saitarn. (in thai).1999.
- [8] Daranee Phutwiboon. **Management Credit** . Bangkok : Chulalongkorn University. (in thai).2010.
- [9] Yamane.T.**Statistics: An Introductory Analysis**. (3<sup>rd</sup> ed.) New york : Harper and. Row Publication.1973.
- [10] Chayapar Bunmepipit. **The study the behavior and marketing mix factors affecting the decision to use credit services Housing Savings Bank bang khae**. Master of Arts Program in Public and Private Management Graduate School Silpakorn University. (in thai).2013.
- [11] Warathip Bunprawat. **A study of marketing mix factors on choosing the people's Bank project loan of GSB tungtako, Chumphon**. Bachelor of Business Administration Sukhothaimathirathat University. (in thai).2013.



# Service Areas of Social Studies Program, Faculty of Humanities and Social Sciences, Nakhon Pathom Rajabhat University

Jittrapon Soontorn<sup>1,\*</sup>

<sup>1</sup>Department of Social Studies, Faculty of Humanities and Social Sciences, Nakhon Pathom Rajabhat University, Nakhon Pathom, Thailand

## Abstract

The study of service areas of social studies program, Faculty of Humanities and Social Sciences, Nakhon Pathom Rajabhat University has 2 objectives that are 1.) to analyses the students' decision to studies in Bachelor of Education in Social Studies, (2011 Curriculum) collecting online-questionnaire through social network group of each students' section, 256 students answer the questionnaire. 2.) to analyses the service areas of Social Studies Program, collecting data by giving the represents of each section to interviewing their own friends about the school that they graduated and the location of their school, 358 students answer the questions.

The results of the study 1) Most of students making decision to study in this curriculum by internal factor as future occupation and their interesting in curriculum. During study in this curriculum most of students live in dormitory around the university and using motorcycle in everyday life.

2.) Service areas of social studies program, students who come to study in this curriculum mostly come from Nakhon Pathom, Suphan Buri, Ratchaburi and Kanchana Buri Province. And students from Amphoe Muang Nakhon Pathom are the most highly every year even though Social Studies Program have decreasing the number of new student from 152 students in 2013 to 40 students in 2016.

**Keywords:** Service Area, Social Study, Decision, Dormitory

## 1. Introduction

Social Studies Program of Nakhon Pathom has a Bachelor of Education in Social Studies curriculum which is teaching and preparing students for being a social studies teacher. Many students interesting in this curriculum. In 2011 academic year, 1<sup>st</sup> year students are nearly 300 after that the teacher council of Thailand (Khurusapha) had limitation the number of students [1] then 2015 academic year, 1<sup>st</sup> year students are only 40. Even though the quota of students to study in this curriculum has been limited but if we considered in the numbers of students who had registered to the admission test. There are 4-5 times greater than the quota of 1<sup>st</sup> year students in that academic year. One of Nakhon Pathom Rajabhat University's mission is to developing the local. Social Studies Program is the one department that producing the teachers to serving to local area around university. From this situation the researcher is trying to investigate the service area of Social Studies Program for the making an improvement and preparing the way to teaching and to analyses the students' decision to studies in Bachelor of Education in Social Studies.

## 2. Research objectives

- 2.1 To analyses the students' decision to study in Bachelor of Education in Social Studies
- 2.2 To analyses the service areas of Social Studies Program

## 3. Materials and methods

This research is focuses on the students who study in Bachelor of Education in Social Studies, (2011 Curriculum). Dividing into 2 parts, the first part is analysing students' decision to studies in Bachelor of Education in Social Studies collecting data by using online-questionnaire, 256 students answer this question. The Second part is analysing service areas Social Studies Program by collecting data about the school's location that students had been graduated, 358 students answer this question.

### 3.1 Materials

Populations of this study are 402 Social studies students from 7 sections who study in 5<sup>th</sup> year, 4<sup>th</sup> year, 3<sup>rd</sup> year and 2<sup>nd</sup> year in 2017 Academic year [2].

---

Corresponding author; e-mail: jittrapon@webmail.npru.ac.th

Preparing questionnaire for analyzing students' decision to study in Bachelor of Education in Social Studies from the related factor such as 1) Reason of decision to study in this curriculum. 2) Admission rounds to study in this curriculum 3) Hometown, Accommodation and Vehicle in everyday life.

Collecting data by using online-questionnaire, Social network group of each students' section is the tool that the researcher uses to providing the questionnaire by posting a link (URL). Then students can answer questionnaire through laptop computer, tablet or mobile phone, 256 students answer the questionnaire.

About students' high school data, the represents of each section interview their own friends about the school that they graduated and the location of their school, 358 students answer the questions.

Analyzing data, in the 1<sup>st</sup> objective about students' decision to student in this curriculum is using percentage to comparing students' reason of decision from each academic year of admission. The 2<sup>nd</sup> objective about service area of social studies program is using percentage to comparing the factor of hometown, accommodation and vehicle in students' everyday life. Using Geographic Information System (GIS) to managing spatial data, analyzing the service areas and illustrating as a map [3], [4].

### 3.2 Method

Decision making method, the process of people to choose to buy or receive any service in everyday life. People always making decision under their own knowledge, information and limited of the situation. Decision making method consist of 2 factors which are 1) Internal factor such as Needs, Motive, Personality, Attitude, Perception and Learning., 2) External factor such as Economy, Family, Social, Culture and Environment [5].

Central place theory developed by Walter Christaller. A theory that divide the size of market places as a hierarchy and investigate the gravity that force people to buy or receive a service from any market places. The ranks of hierarchy from the smallest to the biggest are Hamlet, Village, Town, City and Regional Capital. Each rank of place has their own range of goods as upper limit and lower limit. The upper limit related to the gravity from each factor that can motivated people from faraway place come to buy or receive a service from this place. The lower limit related to gravity from each factor that can motivated people in the area come to buy or receive a service again or making the business stay in stable situation [6].

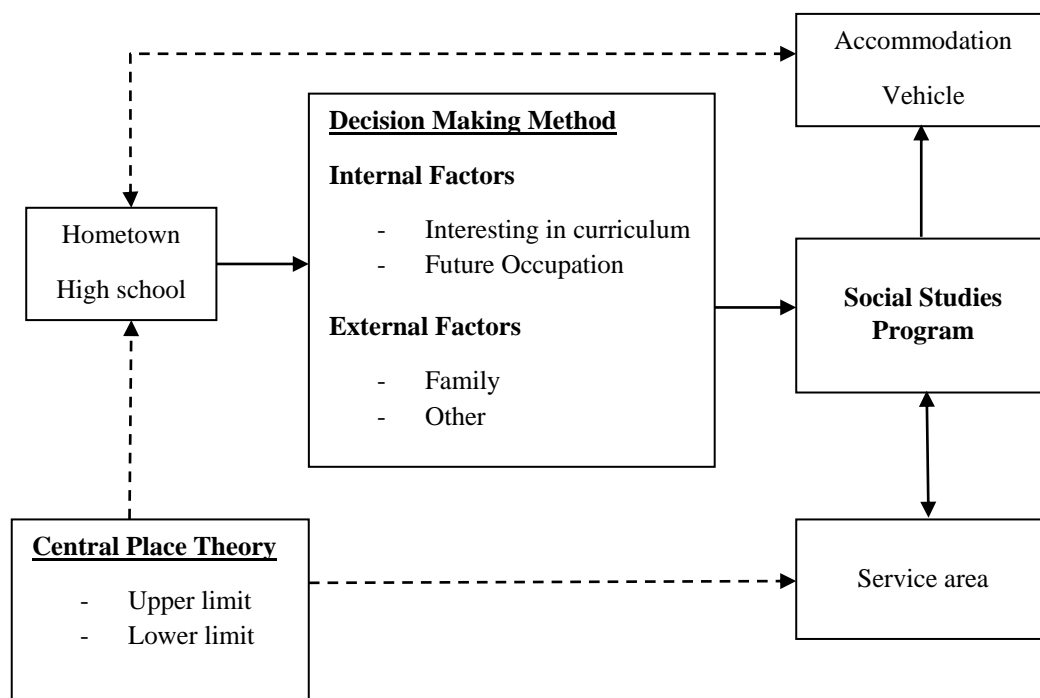


Figure 1 Conceptual framework

## 4. Results and discussion

4.1 The students' decision to Studies in Bachelor of Education in Social Studies from 256 students found that most of students 55.47 percentage choose to study in this curriculum because of the future occupation, Social Studies Teacher. The Second reason, 30.08 percentage are interested in the subjects that teach in this curriculum. Advice from family or other factor are not be influenced to the decision of student to study in this curriculum. If considered in each academic year, the future occupation factor is the highest reason

for students among other factors. In 2015 academic year, most of students 81.63 percentage pay attention to this factor.

**Table 1** Reason of decision to study in this curriculum

Year of Admission/ Factor	Interested in curriculum		Future occupation		Advice from family		Other		Total	
	n	percentage	n	Percentage	n	percentage	n	percentage	n	percentage
2013	30	29.41	49	48.04	14	13.73	9	8.82	102	100.00
2014	32	39.51	38	46.91	3	3.70	8	9.88	81	100.00
2015	6	12.24	40	81.63	1	2.04	2	4.08	49	100.00
2016	9	37.50	15	62.50	0	0.00	0	0.00	24	100.00
Total	77	30.08	142	55.47	18	7.03	19	7.42	256	100.00

In the case of willingness to study in this curriculum, 65.63 percentage of all student are making the registration to the university by passing the first round admission examination test and 27.34 percentage of all students are making the registration to the university by passing the second round admission examination test. The third round admission examination test set up in case of substitution and only 7.03 percentage of all students passing the admission examination test in this stage. (Table 2)

**Table 2** Round that pass the admission examination test

Year of Admission	1st. Examination		2nd Examination		3rd Examination		Total	
	n	percent	n	percent	n	Percent	N	percent
2013	82	80.39	15	14.71	5	4.90	102	100.00
2014	60	74.07	10	12.35	11	13.58	81	100.00
2015	14	28.57	34	69.39	1	2.04	49	100.00
2016	12	50.00	11	45.83	1	4.17	24	100.00
Total	168	65.63	70	27.34	18	7.03	256	100.00

After the investigating to student's hometown the reacher found that social studies students are from many provinces around Nakhon Pathom Province. Then not everyone can be going home every day. Only 31.25 percentage of students can go home every day and most of them are from Nakhon Pathom Province. 61 of 67 students (91.04 percentage) from Suphan Buri Province and 35 of 42 students (83.33 percentage) from Kanchanaburi Province choose to stay in dormitory because the distances are too far and the lack of public transpotation if class finished late they will not have a bus to go home (Table 3 and Figure 2).

**Table 3** Accommodation type by Student's hometown

Province/Accommodation	Going Home		Dormitory		Total	
	n	percent	n	percent	N	Percent
Kanchanaburi	7	16.67	35	83.33	42	100.00
Nakhon Pathom	52	71.23	21	28.77	73	100.00
Ratchaburi	10	32.26	21	67.74	31	100.00
Suphan Buri	6	8.96	61	91.04	67	100.00
Samut Sakhon	2	22.22	7	77.78	9	100.00
Samut Songkham	1	12.50	7	87.50	8	100.00
Others	2	7.69	24	92.31	26	100.00
Total	80	31.25	176	68.75	256	100.00

In the dairy life, students have to go to university everyday if considered in the type of vehicle by student's accommodation, there are 80 students who going home every day 52.50 percentage of them go to university by public bus that not too expensive, 33.75 percentage go to university by private motorcycle and only 8.75 percentage go to university by private car. 179 students live in dormitory 56.25 percentage of them

mostly walk to university because the distances between university and dormitory are not too far about 5-10 minutes. The vehicle that students mostly use is private motorcycle (32.39 percentage) (Table 4)

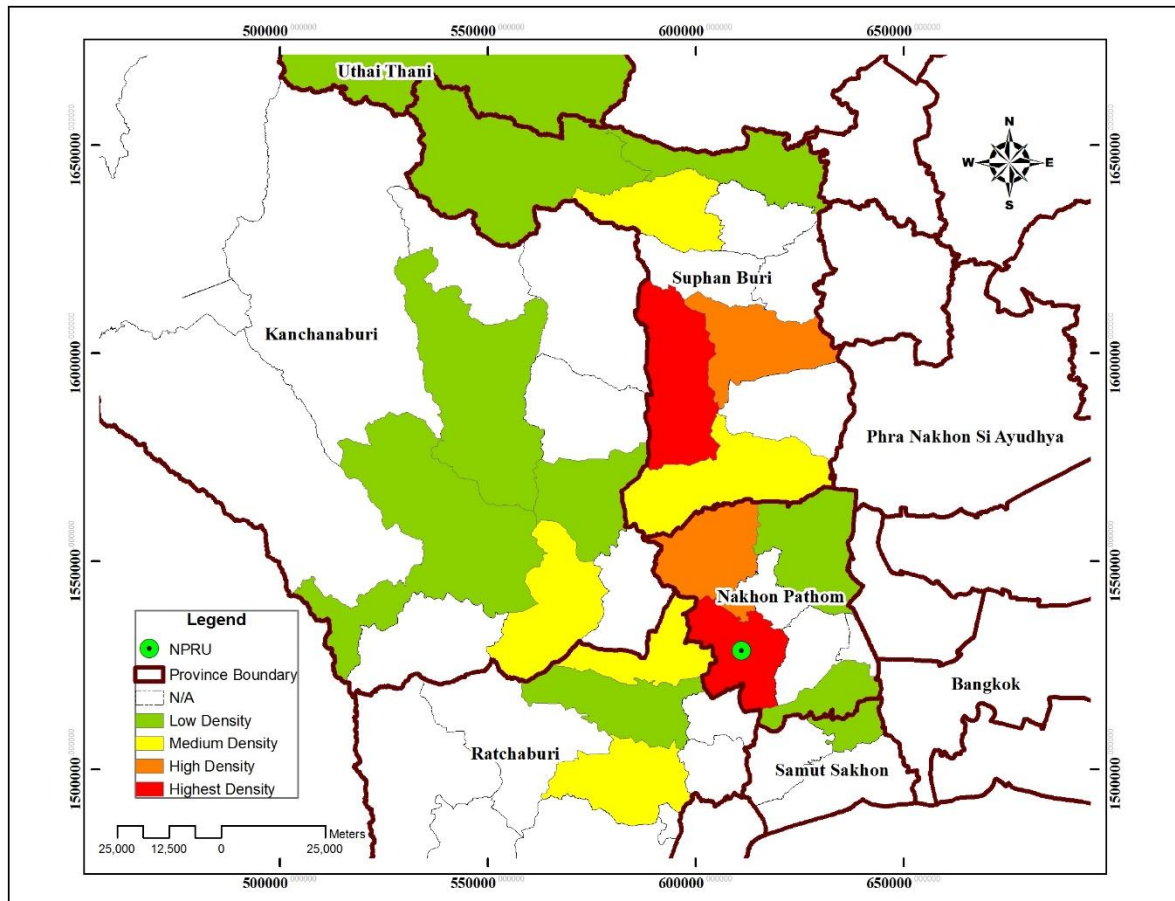
4.2 The service areas of Social Studies Program between 2013-2016 academic year; students are studying in the same curriculum. Found that Students who study in this curriculum mostly come from Nakhon Pathom, Suphan Buri, Ratchaburi and Kanchana Buri Province. Most of students come from Amphoe Muang Nakhon Pathom every academic year, 68 students or 18.99 percentages. The second is Amphoe U Thong, Suphan Buri Province, 27 students or 7.54 percentages. The third is Amphoe Kam Paeng Saen, Nakhon Pathom Province, 23 students or 6.42 percentages. Consider in Table 5, Top 8 of school's location are nearby Nakhon Pathom Rajabhat University. Students from Amphoe Muang Nakhon Pathom are the most highly every year even though Social Studies Program have decreasing the number of new student from 152 students in 2013 to 40 students in 2016. (Table 5 and figure 2)

**Table 4** Vehicle that uses by Student's Accommodation

Accommodations /Vehicle	Going Home		Dormitory		Total
	n	percent	n	percent	N
Walk	0	0.00	99	56.25	99
Bicycle	2	2.50	8	4.55	10
Public Motorcycle	2	2.50	7	3.98	9
Private Motorcycle	27	33.75	57	32.39	84
Public Bus	42	52.50	1	0.57	43
Private Car	7	8.75	4	2.27	11
Total	80	100.00	176	100.00	256

**Table 5** The service areas of Social Studies Program

No.	Amphoe	Province	2013	2014	2015	2016	Total	Percentages of all students
1	Muang Nakhon Pathom	Nakhon Pathom	23	16	13	16	68	18.99
2	U Thong	Suphan Buri	13	9	2	3	27	7.54
3	Kam Paeng Saen	Nakhon Pathom	9	8	5	1	23	6.42
4	Muang Saphan Buri	Suphan Buri	6	10	3	1	20	5.59
5	Muang Ratchaburi	Ratchaburi	5	3	5	0	13	3.63
5	Song Phi Nong	Suphan Buri	5	3	3	2	13	3.63
6	Banpong	Ratchaburi	8	2	1	0	11	3.07
6	Nong Ya Sai	Suphan Buri	5	3	2	1	11	3.07
7	Tha Muang	Kanchanaburi	4	6	0	0	10	2.79
8	Muang Kanchanaburi	Kanchanaburi	3	3	1	2	9	2.51
8	Bang Len	Nakhon Pathom	3	4	0	2	9	2.51
8	Photharam	Ratchaburi	2	2	3	2	9	2.51
8	Doem Bang Nang Buat	Suphan Buri	2	5	1	1	9	2.51



**Figure 2** Service Areas of Social Studies Program

## 5. Conclusions

This research found that the reasons that students making decision to study in this curriculum most is internal factor as interesting in this curriculum and future occupation and external factor as advise from family and other reasons affected to students' decision less. As same as Methawee Sukpan's study "factors affecting the decision to study for high vocational certificate: A case study of Thonburi Commercial Collage" which found that internal factor as the interesting or proficiency of students is the most factor that made students making decision to study in those curriculum [7]. During study in this curriculum most of students live in dormitory around the university and using motorcycle in everyday life because of the convenient [8] then the university must be finds the way to prevents traffic accidental for their student too.

The educational institutions such as schools, high-schools, colleges and universities should locate in the urban zone for the convinence of the students [9] like Nakhon Pathom Rajabhat University. In case of service areas of social studies program consider in central place theory found that between 2013-2016 academic years mostly come from nearby provinces which are Nakhon Pathom Province, Suphan Buri Province, Ratchaburi Province and Kanchana Buri Province. By setting Nakhon Pathom Rajabhat University as the node of central place, the upper limit of good can making the distance faraway to Uthai Thani Province and Kanchana Buri Province but the density of students from those areas is low, in the future students may making decision to study in another university. The lower limit of good from this study found that Nakhon Pathom Province and Suphan Buri Province are the province that have the highest density, every academic year students from these provinces always come to study in this curriculum.

## References

- [1] Piyawan P. **Rajabhat accepted teacher's bachelors limitation [Internet]**. Daily News; 25 July 2013 [cited 30 September 2017]. Available from: <http://www.moe.go.th/moe/th/news/detail.php?NewsID=33446&Key=hotnews>
- [2] The office of academic promotion and registration. **Number of Students**. Nakhon Pathom Rajabhat University; 2017
- [3] Drew G. **What is a Cartogram? [Internet]**. Population Connection; 29 August 2014 [cited 30 September 2017]. Available from: <https://www.populationeducation.org/content/what-cartogram>
- [4] Sandra D, Ernst S. **Thematic Cartography. [Internet]**. GIIT; 29 March 2017 [cited 30 September 2017]. Available from: [http://www.gitta.info/ThematicCart/en/html/Typogr\\_Design\\_learning\\_Object5.html](http://www.gitta.info/ThematicCart/en/html/Typogr_Design_learning_Object5.html)
- [5] Tharinee P. **Factors Affecting Overseas Students' Decisions on Advanced Study in the International Undergraduate Program, in Bangkok Metropolitan Region: [Thesis]**. Rajamangala University of Technology Thanyaburi; 2011.
- [6] Valapha P. **Application of Central Place Theory to the Analysis of Secondary School Service Areas in Changwat Nakhon Ratchasima: [Thesis]**. Chiang Mai University; 1999.
- [7] Methawee S. **Factors Affecting the Decision to Study for High Vocational Certificate: A Case Study of Thonburi Commercial Collage: [Thesis]**. Dhurakij Pundit University; 2013.
- [8] Chadchawan V. **Factors Influencing the Decision to Stay Living in the Residence of the Consumers in Amphoe Mueang Nakhon Pathom Province: [Independent Study]**. Silpakorn University; 2010.
- [9] Policy and Planning Division, Department of City Planning, Bangkok. **Report: Distribution of School in Bangkok 2011 Academic Year; 2012.**

## Reticent factors of Thai EFL students: a case study of undergraduate students in faculty of education, Phuket Rajabhat University

Thanawan Kongkaw<sup>1,\*</sup>, Salaiya Hankhiew<sup>2</sup>, Pratchaya Chuayjaroen<sup>2</sup>,  
Sofiya Che-ousen<sup>2</sup>, and Yawahir Dolah<sup>2</sup>

<sup>1</sup>Lecturer, Department of English, Faculty of Education, Phuket Rajabhat University

<sup>2</sup>Student, Department of English, Faculty of Education, Phuket Rajabhat University

### Abstract

The existence of students' reticence in an English classroom has been one of the interesting topics for discussions among EFL/ESL teachers. This study was conducted to investigate factors causing students' reticent behavior in Thai EFL classrooms. There were 30 undergraduate students from English major and 24 students from non-English major participating in the study. These students were studying in the faculty of Education at Phuket Rajabhat University. Even though the students were from different educational fields, they enrolled in a General English course of the university. To reach the aims of the study, three types of instruments including a questionnaire, interviews and classroom observations were employed. The results revealed that the majority of English and non-English major students rather had a strong desire to speak English with their teacher and classmates in their General English classes. However, some of them were still observed as reticence in the classroom. From having deep interviews with five English major and two non-English major students, it was discovered that both of them similarly worried about their English proficiency, their English grammar and pronunciation, when performing oral classroom activities. In particular, the non-English major students concerned on their English vocabulary knowledge. During the interviews, one of them was found as lack of confidence to speak English while another did not like English subject and English classroom activities. These made the students did not want to speak English in the classrooms. Besides, the two groups of students regarded teaching methodologies, teaching styles and personalities of a teacher as factors generating their reticent behavior in English classrooms. All these results showed that, without the above mentioned factors, the majority of the students participating in the study were still willing to orally participate in their English classrooms.

**Keywords:** reticence, reticent behavior, unwillingness to communicate

### 1. Introduction

Students' reluctance to participate in classroom activities has been a concerning issue among several teachers for decades. This is because classroom participation has a significant correlation with students' academic achievement. It could lead to the success of their learning [1, 2]. Moreover, classroom participation helps the students develop their knowledge and critical thinking skills while performing tasks [3]. As a results, several teachers attempt to engage their students in the classroom activities.

In the field of learning English as a second or foreign language (ESL or EFL), oral classroom participation is very vital to students for several reasons. The oral classroom participation not only offers opportunities for students to expose the target language, but also the opportunities to learn new vocabulary [4, 5]. More importantly, engaging in the oral classroom activities allows the students to estimate their capability of using the target language in a real communicative situation [3]. Consequently, the students who frequently participate in the activities more improve their speaking skill than the students who do not.

From the above mentioned paragraph, it could show that oral classroom participation offers benefits to students' improvement in English leaning. However, being able to speak English in English classroom activities is not an easy skill to learn for foreign students. This is because the ability to speak English requires students' mastery of several key English elements including communicative competency, articulation, grammatical rules, and vocabulary words [6, 7]. Besides, the students need to regularly practice speaking English in order to build their confidence to speak English<sup>5</sup>. Consequently, such language difficulties make students unconfident to speak English and finally form their reticent behavior in English classrooms [8, 9, 10, 11].

#### 1.1 Reticence

Over decades, a number of researchers [12, 13, 14, 15, 16] have tried to explain an existence of reticent behavior within an individual. Originally, the term "reticence" was coined by Phillips [14] in 1965. He stated

\*Corresponding author; e-mail: kk.thanawan@gmail.com

that a reticent individual is the person who has “anxiety about participation in oral communication outweighs his (or her) projection of gain from the situation [15]”. However, he revised his reticent theory and shifted the focus of it to the predisposition of communication behavior. The new theory of reticence concentrated on individual’s intention to avoid “communication situations, when possible, and by inept performance in situations that cannot be avoided [16]”.

Few years later, Keaten and Kelly [12] revisited Phillips’ reticent theory [14, 15, 16]. They thought that reticence was associated with anxiety of people. Reticence was a consequence of an individual’s worry about his or her communicative ability. To them, reticent people usually perceived themselves as unskilled communicators. Most of the reticent people chose to “remain silent than risk appearing foolish [12]” in front of other people. This notion was similar to that of McCroskey [13] proposing that reticence is “a trait of an individual which results in that individual characteristically remaining silent rather than participation in a communication [13]”.

### 1.2 Literature review

Concerning on the problem that might be generated by reticence, myriad researchers have begun to seriously study causes of reticence especially in EFL/ESL classrooms. For example, Flowerdew *et al.* [10] and Flowerdew and Miller [8, 9] conducted three studies to investigate problems and causes of Hong Kong students’ unwillingness to communicate in English classrooms. The results from the three studies concurred that both teacher and the students themselves were the major causes generating students’ reticent behavior in English classrooms. The causes included students’ difficulties in using English, students’ fear of embarrassment, and teachers’ teaching methodologies and styles namely. These results were similar to the results of recent studies of Xie [17] and Hamuda [11] which explored reticent behavior of Chinese and Saudi EFL students respectively.

In the same way, Liu [4, 5] studied causes of Chinese students’ reticence in English classrooms. He discovered that the majority of non-English major students enjoyed participating in oral classroom activities. However, the reticent behavior still existed within the students at all levels of English proficiency. As concluded by Liu, reticent behavior within this group of students was caused by language anxiety, Chinese cultures, and students’ personalities, English proficiency and past educational experience. These were more or less the same as the findings of R.S. and H.S.’s study [18]. These researchers investigated reticent behavior in English classrooms of 78 Malaysian students who were studying in English major. After using the Reticence Scale-12 (RS-12) to gather the data, they found that the students at all levels of language proficiency were anxious and experienced reticent behavior in their classrooms. Specifically, the students rather had a high level of reticence in the classrooms. Apart from students’ anxiety when speaking English, students’ ability to speak English was another obstacle causing reticence within these students. The latter findings of Bakkash and Chalak’s study [19] were in accordance that of Liu [4, 5] and R.S. and H.S.[18].

Likewise, the recent study of Izadi and Zare [20] which examined reticent factors of Iranian EFL students reported parallel results. From the Oxford Placement Test, the Unwillingness-to-Communicate Scale (UCS), Foreign Language Classroom Anxiety Scale (FLCAS) and the Vocabulary Size-Test of Controlled Productive Ability (VTCPA), the two researchers found that the students also had a high degree of reticent behavior. They avoided engaging in communicative situations. Worse yet, they had a negative attitude towards English communication. These two researchers discovered that the reticent behavior of the students was generated by a lack of vocabulary knowledge which could finally lead to language anxiety

In Thai EFL context, Thai teachers have also conducted studies [21, 22] to address the existence of reticence of Thai EFL students. For example, Oradee [21] conducted a classroom research to reduce reticent behavior and to develop English speaking abilities of the students. Finally, she discovered that classroom discussions, problem-solving and role-playing could promote oral classroom participation as well as boost positive attitudes towards oral classroom activities within her students. Few years later, Pattapong [22] conducted another interesting study with an aim to particularly identify causes of reticence in Thai EFL students. Her study focused on factors influencing 29 Thai EFL students’ decision to speak or not to speak in their English classes. Pattapong concluded in her study that social- psychological context, classroom context, cultural context, and social- individual context contributed to students’ reticence in oral classroom activities.

From the literature review mentioned in the previous paragraphs, it shows that a number of researchers concerned on the existence of reticence and problems that might be urged by such the behavior. Notwithstanding, few studies were invented to deeply understand the reticent phenomenon of Thai EFL



students. Hence, the present research focused on the reticent behavior of EFL undergraduate students from the Faculty of Education, Phuket Rajabhat University. Also, the study aimed to explore possible causes of reticence within the students.

## 2. Research objectives

The present study was conducted with two main objectives. One is to explore the existence of reticent behavior of English and non-English major students studying in General English Course at Phuket Rajabhat University. Another objective is to identify factors contributing to the reticent behavior of English and non-English major students if any. Two research questions were then set to frame the study.

2.1 Were English and non-English major students reticent in English classrooms? If yes, to what extent were they reticent?

2.2 What were factors causing English and non-English major students' reticence in English classrooms?

## 3. Material and methods

This study employed both quantitative and qualitative data collection tools to gather the data about reticence of EFL undergraduate students in the faculty of Education at Phuket Rajabhat University. The data collect tools and procedure were described as follows.

### 3.1 Data collection tool

Three types of data collection tools were used to investigate English and non-English major students' reticence in English classrooms including a set of questionnaire, classroom observations and interviews.

#### 3.1.1 Questionnaire

The questionnaire used in the study was adapted from Talley [23] to suit EFL students' context in Thailand. Totally, it consisted of 20 items concerning possible factors causing reticence in English classrooms. A reliability was reported at 0.8. The items were transcribed and administer in Thai using a Five-Point Likert Scale ranging from 1=strongly disagree to 5=strong agree. Both English and non-English major students completed the questionnaire and returned it to the researchers within 30 minutes.

#### 3.1.2 Classroom observations

Apart from the questionnaire, classroom observations were also employed in order to observe students' learning behaviors in the English classrooms during the first semester of academic year 2016.

#### 3.1.3 Interviews

To obtain in-depth information, semi-structure interviews were conducted with five volunteer students from English major and the other two volunteer students from non-English major. The interview questions were adapted from Yang [24], and it totally consisted of 9 questions. However, the interviewees were allowed to freely express their opinions and thoughts concerning causes of the reticence.

### 3.2 Participant

The participants of the study were first-year students studying in the Faculty of Education at Phuket Rajabhat University. The total number of participation was 54. There were 30 students from English major, and the other 24 students from non-English major. All of them enrolled in one General English Grammar course at the university.

### 3.3 Data collection procedure

The data of this study was conducted for one semester (September to December 2016). First of all, the researchers asked a permission to observe the classroom with the instructor of the course. Then, the researchers distributed the questionnaire to students and observed their classroom participation. After the course ended, the interviews were arranged with five volunteers from English major and the other two volunteers from non-English major students.

### 3.4 Data analysis

The data obtained were analyzed using both quantitative and qualitative data analysis methods. To do so, the data from the questionnaire was statistically calculated using mean score ( $\bar{x}$ ) and standard deviation (S.D) to identify the five highest and five lowest average score items ranked by the students. Moreover, the data obtained from the questionnaire, classroom observations and interviews were triangulated and reported in terms of their relationship.

## 4. Results and discussion

### 4.1 Results

#### 4.1.1 Reticence of students

##### 4.1.1.1 Reticence of English major students

In general, the results from the questionnaire clearly showed that many students rather had positive attitudes towards participating in oral classroom activities. It is reported in the table 1.

**Table 1** Five Highest Average Score Items of English Major Students

Items	$\bar{x}$	S.D
1. I voluntarily participate in English lessons.	4.07	.691
2. Teacher gives me lots of tips on how to improve my English speaking skill.	4.00	.830
3. Teacher often encourages me to speak English in the class.	3.93	.785
4. I like to get involved in group discussions in English.	3.90	.662
5. I enjoy studying with teacher and classmates during English lessons.	3.90	.602

Table 1 reports the five highest average score items rated by the English major students. Obviously, it shows that the majority of them volunteered to speak English with their teacher and friends during English lessons and activities. The students admitted that their teacher had much influences on encouraging them to speak English. The teacher suggested techniques and motivated them to improve their English speaking skill. These made the majority of them enthusiastic to study and willing to use English during the English classroom activities.

Nevertheless, the results from the questionnaire also informs five lowest average score items which could possibly be causes of English major students' reticence in the classrooms. They are reported in table 2.

**Table 2** Five Lowest Average Score Items of English Major Students

Items	$\bar{x}$	S.D
1. I am confident that I use correct grammar.	2.67	.691
2. I am confident about speaking English in front of the class.	2.97	.830
3. I have self-confidence when I pronounce English words	3.10	.785
4. I have no fear speaking up in English in the group.	3.30	.662
5. Teacher has a good sense of humor	3.53	1.236

Table 2 reports five lowest average items that were evaluated by English major students. The table showed that several students were unconfident with their English grammar knowledge. A lot of students were unconfident to speak English in front of the class. Also, a number of them had low self-confidence when pronouncing English words. A fear of speaking up in English in the group and teacher's humor in the classroom also affected a degree of students' oral classroom participation.

##### 4.1.1.2 Reticence of non-English major students

The results of the questionnaire completed by non-English major students reveal their positive attitude towards oral classroom activities. However, their degree of classroom participation actually concerned on their teacher. It is presented in Table 3.

**Table 3** Five Highest Average Score Items of non- English Major Students

Items	$\bar{x}$	S.D
1. I think my teacher gives everyone an equal chance to take turns in English speaking.	3.75	.897
2. Teacher does not interrupt me when I speak English.	3.67	.482
3. Teacher praises students very often.	3.67	.868
4. I enjoy studying with teacher and classmates during English lessons.	3.62	.647
5. Teacher gives me lots of tips on how to improve our English	3.62	.824

Overall, table 3 presents that non-English major students enjoyed studying English. Nevertheless, their participation in oral classroom activities depended on their teacher. The students admitted that their teacher provided them an equal opportunity to speak English in the classroom, and their teacher rarely interrupted them while speaking. Also, the teacher gave them a compliment every time they tried to speak English. In addition,

like English major students, this group of students agreed that they enjoyed learning English with their teacher and classmates, and their teacher suggested ways to develop their English abilities.

On the contrary, the results from the questionnaire also indicated other five lowest average score items. They were presented in Table 4.

**Table 4** Five Lowest Average Score Items of non- English Major Students

Items	$\bar{x}$	S.D
1. Teacher lets me speak in English when I have a group work.	2.62	.875
2. I am confident that I use correct grammar.	2.79	.721
3. I am confident about speaking English in front of the class.	3.00	.835
4. I consider myself good at English.	3.00	.722
5. Teacher often encourages me to speak English in the class.	3.00	.933

From the table 4, it indicates that the teacher rarely provided group work activities for students to practice speaking English. Similar to English major students, many non-English major students were unconfident to speak English because they worried about English grammar. In particular, they lacked of courage to speak English in front of the class. More importantly, more than half of them thought that they were poor at English even though their teacher tried to engage them in oral classroom activities. These could lead to students' unwillingness to speak English in the classroom.

In summary, the majority of the two groups of students were willing to participate in oral classroom activities. Both enjoyed participating in English activities. However, without teacher's force, the results from the two tables clearly showed that English major students had more desire to volunteer to participate in English classroom activities than non-English major students. The results from the questionnaire presents various possible causes concerning students' language anxiety, low self-confidence and a teacher.

#### 4.1.2 Possible factors causing reticence

Eventhough the results from questionnaire showed students' strongly desire to speak English in oral classroom activities, the results from classroom observations and having deep interviews with five English major students and two non-English major students portrayed several factors that could cause the reticent behavior within the two groups of students.

##### 4.1.2.1 Factors of reticence of English major students

The results from interviewing with five English major students uncovered two major factors that might induce reticence within these students. For these students, the reticent factors were mainly derived from language anxiety and a teacher.

##### 1) Language anxiety factors

It was discovered that all of the students attending the interviews worried about their English proficiency. Similar to the results from the questionnaire, most of the students expressed their concerns on their English grammar. Some students worried about their pronunciation. These language anxiety factors made these students afraid of speaking English and of making a mistake. Finally, they would be reticent in the classroom. Here are some remarks of the students during the interviews:

*"I am worried about grammar. I am afraid of using a wrong grammar when speaking"*

*"I have poor English grammar. I can't read some words, so I don't have courage to speak English with friends especially the teacher"*

##### 2) Teacher factors

Apart from factors associated with language anxiety, teacher factors tended to play a role in creating reticent behavior within the English major students. Unlike the results from a questionnaire, some students who attended the interviews conversely pointed out that a teacher had no sense of humor and rarely gave them a compliment after trying to speak English. These occasionally made them reticent in the classroom. Worse yet, some students also indicated that the teacher sometimes forced them to speak English and criticized them if they made mistakes. These teacher personalities really made them reluctant to speak English in the next classroom activities. Moreover, one student further expressed her opinions that an unfairness of proving a chance for each student to speaking English in the classroom could be another cause of her reticent behavior. She pointed out that;

*"My teacher gives the opportunity to speak English to each student unequally. She frequently calls only on some brave students to answer questions. For me, I will sit silently if the teacher does not call my name."*

##### 4.1.2.2 Factors of reticence of non-English major students

From the interviews, it was discovered that possible factors causing reticence within two volunteer students from non-English major students were language anxiety of the students, student personalities and teacher factors.

##### 1) Language anxiety factors

Like English major students, language anxiety was also the major cause of reticence of the non-English major students. These two students thought that they had poor English proficiency, and pronunciation. These findings were in a similar vein with the questionnaire's results. In addition, Miss A said that she knew little about English vocabulary. She could not think of or took a lot of time to think of the vocabulary before speaking. These really made her anxious while speaking English especially with the teacher. Miss A said during the interviews;

*"Sometime I want to answer my teacher's question, but I cannot think of English vocabulary. I do not know how to answer it in English. It takes time to think of the vocabulary. The teacher cannot wait, so it is better for me to keep silent."*

#### 2) Student personality factors

Unlike English major students, the results from conducting interviews with non-English major students revealed that some certain personalities of the students could lead to reticence in their English classroom. Mr. J indicated that he rarely spoke English in the classroom activities because he simply did not like it, and he did not like doing oral classroom activities. Conversely, another student, Miss A, pointed out that she actually wanted to speak English in the classroom, but she did not want to speak with her teacher. As she said, it was too stressful for her. She did not have confidence to speak English with her teacher. She said:

*"Speaking English with a teacher is stressful for me. I don't have a courage. I am afraid of making mistakes."*

#### 3) Teacher factors

Also, some teaching methodologies and teaching style of the teacher literally affected non-English major students' degree of oral classroom participation. Even though the majority of the students rated a teacher's providing of an equal chance to speak English to everyone in the class, one student engaging in the interviews still felt that the chance to speak was still unfair to her. Miss A said;

*"I think that when doing English classroom activities, the teacher sometime did not give an equal chance to take turn speaking English to everyone."*

Moreover, Mr. J advocated that the teacher speak English all the time. This teaching style of the teacher made him feel difficult to follow and reluctant to involve in the oral classroom activities. If he had to communicate in English with his teacher, it was merely a force from the teacher. He said that;

*"I'm not good at English. I do not understand everything when the teacher speaks English and do not translate it in the classroom. When the teacher ask me in English, I was forced to answer. It was difficult for me."*

More interestingly, Miss A said during the interviews that if the teacher used games and short conversation activities and called her name, she would be more willing to engage in oral classroom activities.

#### 4.2 Discussion

As a whole, the results from the three data collection tools concurred that both English and non-English major students actually had a strong desire to speak English in the classrooms. However, English major students had higher degree of voluntarily participate in classroom activities. This might be because this groups of students had higher English proficiency than the latter group of students.

Concerning the factors that possibly caused reticence within the students, the results from the three types of data collection tools concurred that the major cause of reticence found in the two group of students were their own language anxiety including English grammar, pronunciation and English vocabulary. Language anxiety made them unlike participating in oral classroom activities and formed their personality as lack of courage to speak English with friends and teacher. These results were in accordance with those of several previous studies [19, 8, 9, 10, 11, 25, 4, 5, 22]. Apart from language anxiety and personality of students, teacher factors also played a role in determining reticence especially among non-English major students. By knowing or without knowing, teacher's teaching methods, teaching styles and personality affected a degree of students' reticence. These findings were consistent with the findings of Xie [17] and Kongkaw [25] who found that communicative environments the teacher created in the classroom could cause students' reticence.

#### 5. Conclusion

This study investigated reticent behavior of EFL undergraduate students in faculty of Education at Phuket Rajabhat University. The participants of this study were Thai learners of English from English and non-English programs. Based on the obtained data from the questionnaire, classroom observations and interviews, it could be summarized that both groups of students rather had a strong desire to speak English in oral classroom activities especially the English major students. Nevertheless, reticent behavior could also be observed from these two groups of students. The factors contributing to the reticent behavior of English major students were not much different from those of non-English major students. The major factor mentioned by the students from both groups was language anxiety and personality of the students. English major students worried about their English grammar and pronunciation while non-English major students concerned on their knowledge about English grammar, pronunciation and vocabulary. Beside the factors relevant to language anxiety, many of students still

lacked of courage to speak English. Some students merely did not like English and oral classroom activities. Moreover, the teacher could also create reticence within both groups of students through teaching methodologies, teaching styles and personalities. Specifically, English major students were reticent because of teacher personalities and teaching style as providing unfairness of opportunity to speak English in the classroom whereas non-English major students were reticent due to teacher teaching methodologies, and personalities.

Despite such the inquiries, the results of the current study offered an implication for teachers of English. It would possibly help the teachers more understand students' learning behavior and possibly reduce reticence that might occur within the students. Gardner [26] said that concerning learning styles of the students helps the teachers choose suitable teaching methodologies which could reduce students' weakness and reinforce their strength. However, since each classroom is unique [27], more studies should be conducted to identify other possible factors leading to students' reticence in other contexts.

## References

- [1] Tatar S. Why keep silent? The classroom participation experiences of non-native-English-speaking students. *Language and Intercultural Communication* 2005; 5(3-4): 284-293.
- [2] Tsui A. *Introducing Classroom Interaction*. London: Penguin Books; 1995.
- [3] Swain M. *Communicative competence: Some roles of comprehensible input and comprehensible output in its development*. Rowley, MA: Newbury House; 1985.
- [4] Liu M. Causes of reticence in EFL classrooms: A study of Chinese University students. *Indonesian Journal of English Language Teaching* 2005a; 1(2): 220-236.
- [5] Liu M. Reticence in oral English language classrooms: A case study in China. *TESL Reporter* 2005b; 38(1) : 1-16.
- [6] Aungwatanakun S. *English teaching methodology*. Bangkok: Chulalongkorn University Press; 1994.
- [7] Khamkhien A. Teaching English speaking and English speaking tests in the Thai context: A reflection from Thai perspective. *English Language Teaching* 2010; 3(1): 184-190.
- [8] Flowerdew J, Miller L. Students perceptions, problems, and strategies in second language lecture comprehension. *RELC Journal* 1992; 23(2): 60-80.
- [9] Flowerdew J, Miller L. Lecturer perceptions, problems and strategies in second language lectures. *RELC Journal* 1996; 27(1): 23-46.
- [10] Flowerdew J, Miller L, Li DCS. Chinese lecturers' perceptions, problems and strategies in lecturing in English to Chinese-speaking students. *RELC Journal* 2000; 31(1): 116-138.
- [11] Hamouda A. An exploration of causes of Saudi students' reluctance to participate in the English language classroom. *International Journal of English Language Education* 2013; 1(1): 17-34.
- [12] Keaten JA, Kelly L. Reticence: An affirmation and revision. *Communication Education* 2000; 49(2): 165-177.
- [13] McCroskey JC. Oral communication apprehension: A summary of recent theory and research. *Human Communication Research* 1997; 4(1): 78-96.
- [14] Phillips GM. The problem of reticence. *Pennsylvania Speech Annual* 1965; 22: 22-38.
- [15] Phillips GM. Reticence: Pathology of the normal speaker. *Speech Monographs* 1968; 35(1): 39-49.
- [16] Phillips GM. *Avoiding communication: Shyness, reticence, and communication apprehension*. 2<sup>nd</sup> ed. NJ: Hampton Press; 1997.
- [17] Xie X. Why are students quiet? Looking at the Chinese context and beyond. *ELT Journal* 2010; 64(1): 10-20.
- [18] Soo RS. Reticence students in the EFL classrooms. *Advances in Language and Literature Studies* 2013; 4(2): 65-73.
- [19] Baktash F, Chalak A. The relationship between reticence and personality types in Iranian University EFL classrooms. *Theory and Practice in Language Studies* 2016; 6(5): 1000-1005.
- [20] Izadi M, Zare M. Reticence in EFL speech production: A study of learners' anxiety and vocabulary knowledge. *Working Papers in Language Pedagogy* 2016; 10: 73-86.
- [21] Oradee T. Developing speaking skills using communicative activities (discussion, problem-solving, and role- playing). *International Journal of Social and Science and Humanity* 2012; 2(6): 533-535.
- [22] Pattapong K. Complex interactions of factors underlying Thai EFL learners' willingness to communicate in English. *PASAA* 2015; 49: 105-136.
- [23] Talley PC. Students' responses to Scaffolded learning in the Asian University ESL classroom. *International Journal of Business and Social Science* 2014; 5(3): 235-244.
- [24] Yang CA Mixed-method study about Chinese students' willingness to communicate. *Culminating Projects in English* 2015; 32: 79-32.
- [25] Kongkaw T. *The reticence of EFL/ESL students in an Asian context: Uncovering its myth* [Unpublished Dissertation]. Bangkok: Mahidol University; 2015.

- [26] Gardner H. *Intelligence reframed: Multiple intelligence for the 21<sup>st</sup> century*. New York: Basic Books; 1999.
- [27] Tudor I. Rationality and rationalities in language teaching. *System* 1998; 26(3):319-334.

**Session of Water Engineering,  
Groundwater Hydrology and  
Environmental  
Science**

# The Potential Solutions of Water Resource Problem in Cisarua Sub-District, Bogor, West Java, Indonesia

M. Faisi Ikhwal<sup>1,\*</sup> and Titiek Ujjanti Karunia<sup>2</sup>

<sup>1</sup>A master student of Department of Civil Engineering, Faculty of Engineering, Khon Kaen University, Thailand

<sup>2</sup>A lecturer of Department of Civil and Environmental Engineering, Bogor Agricultural University, Indonesia

## Abstract

Problems of water shortage for domestic uses being experienced in Cisarua Sub-district, as local government fail to offer their people with this basic need. The water from public services such as PDAM seems not enough to cover whole domestic need. The other existing and potential problem is deforestation that causing the increase of runoff volume. Forest Area in Cisarua is a specific territory of forest ecosystem determined and or decided by the government as a permanent forest has violated by society. The cause of land use changes in Cisarua is the growth number of construction especially hotel that increase continuously. The goals of this research were to analyze the tentative or potential ways to solve the water resource problems occurring in Cisarua Sub-district related to water resource. This study used primary and secondary data collected from related governments and interviews with the local people's opinion. Cisarua is included in the climate type Af humid tropical climate (with no real dry months) with rainfall annual average over the period 2003 to 2012 is 3040.6 mm/ year with an average of 253.4 mm monthly rainfall. Domestic customers that use PDAM Tirta Kahuripan in Cisarua sub-district is 1211 households even though at least there are 29148 households that should be connected to piped water. The changes of land use in Cisarua due to weak supervision and control of spatial level both central and local government. The best solution should be used by households is through rainwater harvesting. About 291480 cum will recharged during a month and can cover 66.378 % of water demand. Infiltration wells have been constructed around 201 units. Infiltration wells can reduce runoff that effected by deforestation so that runoff from Cisarua can be injected to soil and a groundwater.

**Keywords:** water shortage, deforestation, Cisarua sub-district, rainwater harvesting, infiltration wells

## 1. Introduction

Problems of water shortage for domestic uses are being experienced in Cisarua Sub-district, as local government fail to provide their people with this basic need. The water from public services such as PDAM (*Perusahaan Daerah Air Minum*) seems not enough to cover whole domestic need. According to data on 2016 (PDAM Tirta Kahuripan) in Cisarua Sub-district, there are 29148 households but until year of 2016 only 1211 households connected with piped water. This condition has forced the residents to adopt different way to fulfill their domestic water needs. They use another water source such as deep water well, shallow, or spring. Most of household in Cisarua Sub-district use wells and boreholes to supplement PDAM's piped water which is inadequate.

In addition to these problems, PDAM also faces problem in distribution system of water. PDAM Tirta Kahuripan has confront a decades-old system of distribution. This problem begins with poor planning, which ultimately affects the development of piping networks and maintenance. Lack of maintenance makes the pipe networks being in a bad condition. Breakages of pipe due to corrosion had compromised water pressure, water supply and water quality.

The other existing and potential problem related to water resource in Cisarua Sub-district is deforestation causing the increase of runoff volume. Forest Area in Cisarua ora specific territory of forest ecosystem that has been determined and or decided by the government as a permanent forest has been violated by society. Water catchment area in Cisarua is increasingly critical. If Area does not receive special attention, land use in the region keep changing and will have an impact on the increase of runoff volume constantly. Based on designation data (2005-2025) by BPDAS (*Balai Pengelola Daerah Aliran Sungai*) examining the spatial and land use changes in Cisarua is that the growth number of construction especially hotel increases continuously.

---

\* Corresponding author; e-mail: faisikhwal@gmail.com



The objective of this research is to analyze the tentative or potential ways to solve the water resource problems occurring in Cisarua Sub-district related to water resource.

**2. Materials and methods**

This study used primary and secondary data collected from related governments and interviews with the local people’s opinion. The available data can be used to figure out specify causes of problem and the tentative or potential ways to solve the problems. A list of needed data has been prepared and then collected via government agencies such as average monthly rainfall and meteorological data, the number of population, household, and density per village in Cisarua Sub-district. In this area, forest inventories studies have been conducted and will be great help in this study. Also, the existing surface and ground water resource were collected to supporting analysis. After the existing data have been collected and analyzed, then determined the causes of problem and draw up the possibilities of solution.

**2.1 The target area**

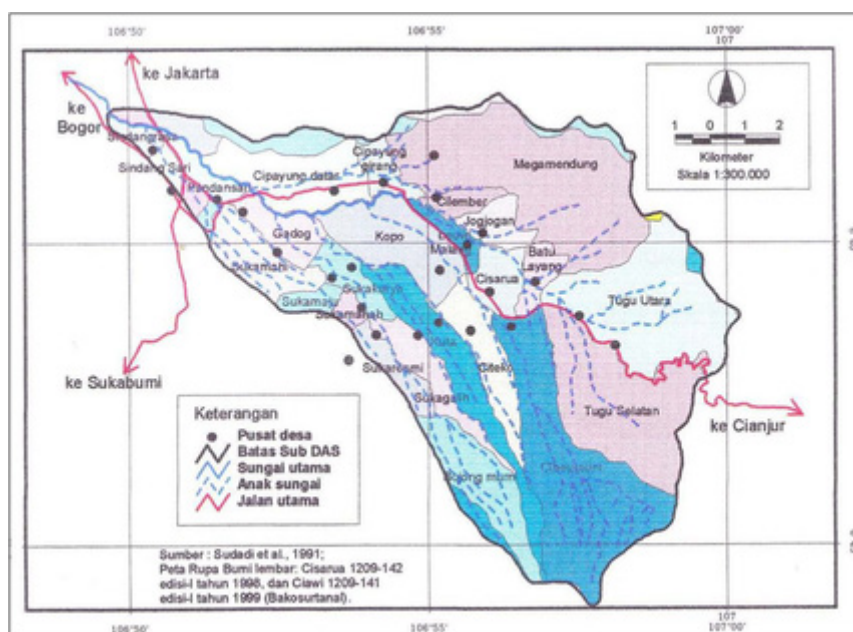
The location of the target area is Cisarua Sub-district that is part of the Upper Ciliwung Watershed located at the geographic coordinates of 6 ° 37 '48 " - 6 ° 46' 12" latitude and 106 ° 49 '48 " - 107 ° 00' 00" E. Cisarua Sub-district map can be seen in Figure 1. Region Morphology type of Cisarua Sub-district is relative highlands. Cisarua Sub-district has 3 sub watersheds as shown in Table 1. Administratively Cisarua Sub-district is located in Bogor Regency including 10 villages. There are Cilember village, Jogjogan village, Batu Layang village, Kopo village, Cisarua village, Citeko village, Leuwimalang village, Tugu Utara village, Tugu Selatan village, and Cibereum village which are part of the Local Government Level II Bogor Regency, West Java Province, Indonesia.

**Table 1** Sub watershed include to Cisarua Sub-district

NO	Sub-watershed	Area (Ha)
1	Ciesek	233.8
2	Ciliwung Hulu	3.739.95
3	Cibogo - Cisarua	2.962.48
	Total	6.936.23

Source: BPDAS Citarum-Ciliwung (2013)

Geographically the layout of the Cisarua Sub-district is very strategic. This is because the Cisarua Sub District is up stream of the capital city of the Republic of Indonesia, so the Cisarua Sub District becomes a buffer area of Jakarta. Cisarua Sub-district has a cool weather that fits into a tourist spot. That is why the growth of hotel and villa increase continuously.



**Figure 1:** Map of Cisarua Sub-District

## 2.2 Data of population in Cisarua Sub-district

BPS-Statistics Indonesia in 2015 has already recorded data of population and household, area, density per sub-district village in Cisarua sub-district to support the activities of the Population, Agriculture, or Economic. The location of this study has an area of 7406.30 ha. Data of population, household, area, and density per sub-district village in Cisarua can be seen with details as shown in Table 2.

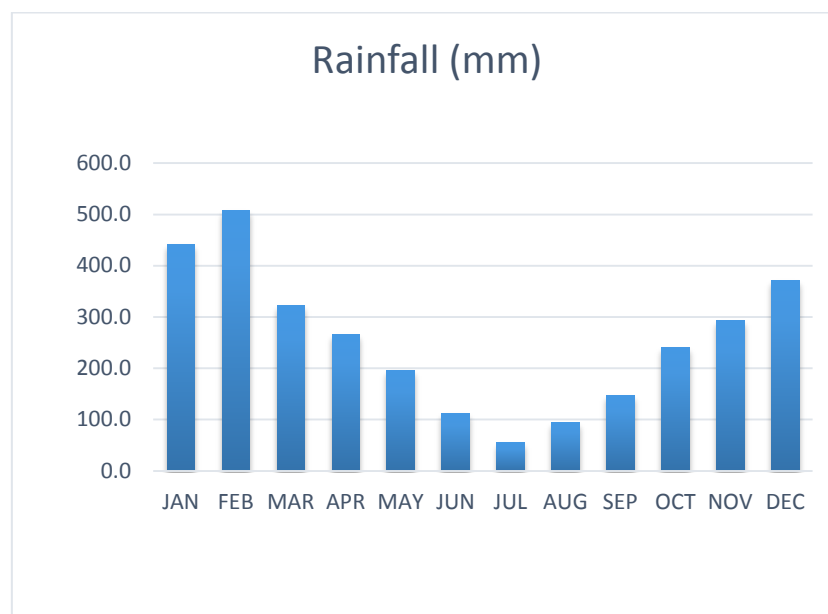
**Table 2** Total population per village in Cisarua Sub-district

Villages	Area (ha)	Proportion (%)	Population			Household	Density Capita/ha
			Male	Female	Total		
Cilember	296.74	4.01	5518	501	6019	2632	20.2837501
Jogjogan	235.64	3.18	4986	4591	9577	235	40.6425055
Batu Layang	272.15	3.67	7698	8590	16288	3212	59.8493478
Kopo	652.6	8.81	9375	8588	17963	5225	27.5252835
Cisarua	240.36	3.25	5662	544	6206	2845	25.8196039
Citeko	585.69	7.91	7359	6664	14023	3536	23.9427001
Leuwimalang	136.98	1.85	3126	3450	6576	2349	48.0070083
Tugu Utara	1201.3	16.22	6696	6096	12792	3402	10.6484642
Tugu Selatan	2665.41	35.99	10877	1005	11882	556	4.45785076
Cibeureum	1119.43	15.11	10837	9815	20652	5156	18.4486748
<b>Total</b>	<b>7406.3</b>	<b>100</b>	<b>72134</b>	<b>49844</b>	<b>121978</b>	<b>29148</b>	<b>16.4694922</b>

Source: BPS- Statistics Indonesian (2015)

## 2.3 Average monthly rainfall data and Meteorological data

Rainfall information is the primary input to any hydrological analysis. Analysis of rainfall characteristics is becoming very important for rainfall forecasting in the context of integrated watershed management planning (Rezaul, 2012). The study area is included in the climate type Af humid tropical climate (with no real dry months) with rainfall annual average over the period 2003 to 2012 is 3040.6 mm / year with an average of 253.4 mm monthly rainfall. Monthly rainfall data (period 2003 to 2012) is depicted in Figure 2.



**Figure 2:** Average monthly rainfall (2003 to 2012)

Source: Stasiun Meteorologi Citeko Bogor (2012)

### 3. Results and discussion

#### 3.1 Causes of problem

##### 3.1.1 Water shortage for domestic uses

Local government in Cisarua sub-district has several projects to provide water for domestic and agriculture uses. For domestic uses the responsible agency is PDAM Tirta Kahuripan. PDAM Tirta Kahuripan's role is to develop and operate water supply systems in Bogor District. The local government provides and subsidies payment for construction costs and most of the operation and maintenance (O&M) costs. Water needed for irrigation is taken from Cisarua river. Volume of this water is saved in reservoirs that are needed to other uses such as flood protection, and recreation. Water used for irrigation is delivered through primary, secondary, canal system. Based on data cited from [1], PDAM Tirta Kahuripan had approximately more than 46 % water loss, due to geological factor, human activity, etc.

According to the data, in 2016 the number of domestic customers that use PDAM Tirta Pakuan in Cisarua sub-district is 1211 households. Water Usage for domestic in Cisarua Sub-district of 2015 is approximately 410,959 m<sup>3</sup> (Including water supply for industrial sector and public buildings). In fact at least there are 29148 households that should be connected to piped water.

This condition has forced the residents to adopt different way to make water available for domestic uses such as deep water well, shallow, or spring. Most households use water from wells and boreholes to supplement PDAM's piped water which is inadequate. Nowadays residents in Cisarua are facing the other problems of water resources with deep water well and shallow. The wells that they build are reduced since the establishment of many large-scale housing, villa and hotels. These constructions take up hundreds hectare areas that seriously affected to water resource (water wells and streams in the area) because they also use the wellbore.

##### 3.1.2 Deforestation (Increasing the volume of runoff)

Forest Area is a specific territory of forest ecosystem determined by the government as a permanent forest. Government decision is important to maintain the size of forest area and to ensure its legitimation and boundary demarcation of permanent forest. Forest area is determined by the Minister of Forestry in the format of Minister Decree on the Designation of Provincial Forest Area and Inland Water, Coastal and Marine Ecosystem. The designation of Forest Area is formulated based on integrated and harmonized of Provincial Spatial Planning (RTRWP) and Forest Land by Concensus (TGHK) (BPS, 2016).

The designation of Forest Area in some cases also cover inland water, coastal, and marine ecosystem that may become part of Sanctuary Reserve Area (KSA) and Nature Conservation Area (KPA). In accordance to the Act on Forestry No. 41/1991, forest area is categorized as Conservation Forest, Protection Forest, Production Forest (BPS, 2016). Forest Area in Cisarua has been determined by Minister as shown in Table 3.

**Table 3** The designation of Forest Area in Cisarua has been determined by Minister (Year 2005-2025). *Source: Afifah (2010)*

No	Designation of Provincial Spatial Planning and Forest Land Use	Area (ha)	Propotion
1	Conservation forest	1237.02	16.7
2	Protection forest	2584.7	34.9
3	Farm area	1107.77	14.96
4	Rural settlements (low density)	134.92	1.82
5	Rural settlements (medium density)	298.82	4.03
6	Urban settlement (low density)	792.74	10.7
7	Urban settlement (medium density)	341.54	4.61
8	Dryland Agriculture Area	834.72	11.27

No	Designation of Provincial Spatial Planning and Forest Land Use	Area (ha)	Propotion
9	Plantation	62.46	0.84
10	River	11.61	0.16
Total		7406.3	100

Source: Afifah (2010)

As shown in Table 3 which has been analyzed by previous researcher [4], Minister of Forestry purposes Conservation Forest area 1237.02 ha (16.7%) and Protection Forest area 2584.7 ha (34.9%) in Cisarua sub-district. Based on Bogor Regency Figure (2016), Conservation Forest means a forest area having specific characteristic established for the purposes of conservation of animal and plant species as well as their ecosystem. Meanwhile Protection Forest is a forest area designated to serve life support system, maintain hydrological system, prevent of flood, erosion control, seawater intrusion, and maintain soil fertility.

Ernan Rustiadi, Senior researcher of the Center for Development Studies Regional Development (P4W) Bogor Agricultural University (IPB), explained the changes of land use in Cisarua sub-district due to weak supervision and control of spatial level both central and local government. Land use for settlement has increased yearly. The land use change in Table 4 shows that a change of land use decided by the government in the target area cause the change of land use from forest to settlement in Cisarua. The decline for forest in the land use results a runoff increase in the target area.

**Table 4** Land use change from Designation of Provincial Spatial Planning and Forest Land Use in Cisarua

No	Area based on designation	Land use change to							
		Building	Farm area	Farm area (tea)	Rural settlements (low density)	Rural settlements (medium density)	Paddy field	Dryland Agriculture Area	Villa/ Hotel
1	Conservation forest	1.33	21.07	70.1	1.03	4.15	0	117.63	1.54
2	Protection forest	6.8	152.02	524.18	11.87	5.19	9.49	9.49	12.87
3	Farm area	21.63	0	0	9.26	32.23	0	354.53	16.68
4	Dryland Agriculture Area	1.39	0	0	0	69.92	0	0	0
5	Plantation	0	0	0	0	3.65	0	22.76	97

Source: Afifah (2010)

### 3.2 Solutions to problem

Water shortage and deforestation are a growing concern for many areas in Bogor including Cisarua sub district. There are several solutions which could lead to solve water shortage and deforestation. Table 5 provides suggestions of tentative or potential ways to solve the problem.

**Table 5** List of potential ways to solve the problem

No	Problems	Causes	Potential Solutions
1	Water shortage for domestic uses	Their yield of wells is reduced since the establishment of many large-scale housing and hotels	Rainwater Harvesting Improve pipe water supply system
2	Deforestation (Increasing the volume of runoff)	Due to weak supervision and control of spatial level both central and local government.	Reforestation law enforcement Re-planning land use Educative Campaigns
3	Increasing the volume of runoff	Land use change	Infiltration wells (Artificial recharging wells)

### 3.2.1 Solutions of water shortage for domestic uses

#### 3.2.1.1 Rainwater Harvesting

Rainwater harvesting is a technique of collection and storage of rainwater into natural reservoirs or tanks, or the infiltration of surface water into subsurface aquifers (before it is lost as surface runoff). One method of rainwater harvesting is to collect water from rooftop. Rooftop harvesting can be used to intercept the flow of rainwater and provide a household with high-quantity water for domestic. Other uses include water for gardens, livestock, and irrigation, etc. Rainwater harvesting can also reduce the volume of runoff (Fayez, 2009). In settlement areas, the roof top rainwater can be conserved and used for collection of water. This approach requires connecting the outlet pipe from rooftop to divert the water to either existing tank or specially designed wells. Schematic of Rainwater Harvesting is depicted in Figure 3.



**Figure 3:** Schematic of Rainwater Harvesting [14]

#### 3.2.1.2 Pipe Water Supply System Improvement

The numbers of PDAM Tirta Kahuripan's customers is still small. Until 2015 the number of customers is still 1211 customers of 29148 households. PDAM Tirta Kahuripan should improve and add the number of customers in Cisarua Sub district. The lack number of customers describes the main problems that are faced by PDAM Tirta Kahuripan are efficiency and reliability.

PDAM Tirta Kahuripan has been working to improve the water supply capacity of these systems by installing new infrastructure including wells, pipe mains, and trench crossings, within the past years. The water company has been working to ensure that its network is connected in such a way that if a pump fails in one area, it can shift water from one area to another area.

### 3.2.2 Deforestation

#### 3.2.2.1 Deforestation prevention

Deforestation involves the conversion of forested regions to non-forest land for the use of pastures for livestock, logging companies, industrial gain, urban use, or simply to become a wasteland. Sadly, the trend has been in existence for many years in Cisarua sub-district, even though Cisarua Sub-district has been designed for conservation forest (16.7 % of total area) and protection forest (34.9 % of total area). As the population and demands on land resources increases, so does the deforestation in watershed will be increasing the volume of runoff.

To prevent deforestation or increase of the runoff, we have to include many stakeholders who live or need in this area to do their part in preventing deforestation. Stakeholders who can be included such as government, ingenious people, private sector, etc. Deforestation or the increase of runoff are a complex problems. While there are several solutions such as reforestation, law enforcement, educative campaigns, and re-planning for land use. These approaches can make a big difference to solve these problems.

#### 3.2.2.2 Reforestation Promotion

Reforestation is the restoration or replanting of forests that have been reduced by the change of land use in Cisarua sub-district. Reforestation is needed because huge areas of forest are being damaged or destroyed by the establishment of settlement in Conservation forest and protection forest. Table 4 shows Land use change from designation of provincial spatial planning and forest land use in Cisarua sub-district.

This deforestation has a number of causes, including fires, the clearing of land to make way for agriculture or human settlement, and logging. In order to tackle deforestation there are a number of stakeholders that aim to replant trees and help to regenerate and restore forest habitats. It requires an ongoing process and should not be viewed as a onetime thing. People, communities, governments, and organizations are all active actors. It involves selecting and dedicating large tracts of land mainly for the purpose of cultivating forests. For instance, in local communities and urban centers, it can be done around market areas or within city parks. [5]

### 3.2.3 Runoff

#### 3.2.3.1 Infiltration wells (Artificial recharging wells)

Artificial recharge well is the practice of decreasing volume of runoff by artificial well. The amount of runoff that flow on the land surface will be injected to a groundwater. This process usually occurs in the vadose zone below plant roots and is often expressed as a flux to the water table surface. Recharge occurs through artificial groundwater recharge, where rainwater and or reclaimed water is routed to the subsurface (Hossam, 2012).

### 3.3 Potential solutions to problem

These are some ideas to help solve the problems that appear. It is essential that everyone must become involved, including governments, after considering many aspects a lasting solution is going to be found. These problems can be done by building more rainwater collector and Infiltration wells (Artificial recharging wells). The main reason for these solution is the high rainfall in the region. This means there are more runoff. The best solution of each problem that appears is tabulated in Table 6.

**Table 6** The best solution of each problem that appears

No	Problems	The best solution
1	Water shortage for domestic use	Rainwater Harvesting
2	Deforestation (Increasing the volume of runoff)	Infiltration wells (Artificial recharging wells)

#### 3.3.1 Rainwater harvesting

Rainwater harvesting is a technology used for collecting and storing rainwater from rooftops, land surfaces, road surfaces or rock catchments using simple techniques such as pots, tanks and cistern as well as more complex techniques such as underground check dams. Harvested rainwater is a renewable source of clean water that is ideal for domestic and landscape uses. Water harvesting systems provide flexible solutions that can

effectively meet the needs of new and existing, as well as of small and large sites. Using a water harvesting system is an ongoing process that can be developed over time (Musa, 2011).

The best solution that should be used by households in Cisarua sub district to get water is through rainfall harvesting. Rainwater harvesting is appropriate to be applied in this area if we consider on rainfall annual average over the period 2003 to 2012 is 3040.6 mm / year with an average of 253.4 mm monthly rainfall. Rainwater harvesting is collected from rooftops through drains or gutters into storage containers like drums and surface tanks, and other storage facilities.

Rainwater harvesting method is low cost, easy maintenance and very effective. Table 8 shows availability of rainwater through roof top rainwater harvesting. Estimation of Availability of Rain Water through Roof Top Rain Water Harvesting in Table 7 if this method to be applied in Cisarua sub district:

**Table 7** Input data for calculating rainwater harvesting

Items	Numbers	Unit	Source of data
Rainfall	253.4	mm/month	Stasiun Meteorologi Citeko Bogor (period 2003 to 2012)
Population	121978	capita	Badan Pusat Statistik (2015)
Households	29148	Units	Badan Pusat Statistik (2015)
Roof top area	48.8	sqm	Badan Pusat Statistik (2015)
Water demand for domestic	0.12	cum/day/capita	Ministry of Public of Works and Housing (MoPWH)

Calculation: Using Table 7 for determine volume water that can be harvested from roof top.

›Water Harvesting = 10 cum/month x 29148 Households  
= 291480 cum

›Water demand for domestic = 0.12 cum/day/capita x 30days x 121978 capita  
= 439120.8 cum

›Water demand/household/month = 0.12 cum/day/capita x 4 persons x 30days  
= 14.4 cum/month = 3804.0776 Gallon

**Table 8** Availability of Rain Water through Roof Top Rain Water Harvesting

Rainfall(mm)	100	200	300	400	500	600	800	1000	1200	1400	1600	1800	2000
Roof top area (sqm)	Harvested water from Roof top (cum)												
20	1.6	3.2	4.8	6.4	8	9.6	12.8	16	19.2	22.4	25.6	28.8	32
30	2.4	4.8	7.2	9.6	12	14.4	19.2	24	28.8	33.6	38.4	43.2	48
40	3.2	6.4	9.6	12.8	16	19.2	25.6	32	38.4	44.8	51.2	57.6	64
50	4	8	12	16	20	24	32	40	48	56	64	72	80
60	4.8	9.6	14.4	19.2	24	28.8	38.4	48	57.6	67.2	76.8	86.4	96
70	5.6	11.2	16.8	22.4	28	33.6	44.8	56	67.2	78.4	89.6	100.8	112
80	6.4	12.8	19.2	25.6	32	38.4	51.2	64	76.8	89.6	102.4	115.2	128
90	7.2	14.4	21.6	28.8	36	43.2	57.6	72	86.4	100.8	115.2	129.6	144
100	8	16	24	32	40	48	64	80	96	112	128	144	160
150	12	24	36	48	60	72	96	120	144	168	192	216	240
200	16	32	48	64	80	96	128	160	192	224	256	288	320
250	20	40	60	80	100	120	160	200	240	280	320	360	400
300	24	48	72	96	120	144	192	240	288	336	384	432	480
400	32	64	96	128	160	192	256	320	384	448	512	576	640
500	40	80	120	160	200	240	320	400	480	560	640	720	800
1000	80	160	240	320	400	480	640	800	960	1120	1280	1440	1600
2000	160	320	480	640	800	960	1280	1600	1920	2240	2560	2880	3200
3000	240	480	720	960	1200	1440	1920	2400	2880	3360	3840	4320	4800

Source: Central ground water board ministry of water resources (2000)

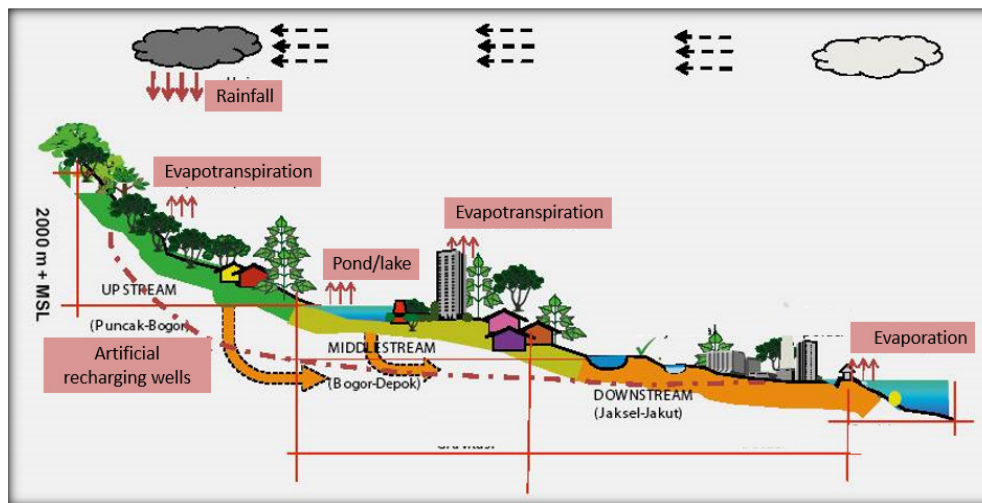
In Cisarua sub-district roof top rain water experiment can be done in this area where the roof top rain water collected from the roof will be stored into the existing water supply tank of the buildings. About 291480 cum will be recharged during a month and can cover 66.378 % of water demand.

Infiltration wells (Artificial recharging wells)

3.3.2 Artificial recharge of groundwater is achieved by storing surface water in basins, furrows, ditches, or other facilities where it infiltrates into the soil and moves downward to recharge aquifers. Artificial recharge is increasingly used for short- or long-term underground storage, where it has several advantages over surface storage, and in water reuse. To design a system for artificial recharge of groundwater, infiltration rates of the soil must be determined and the unsaturated zone between land surface and the aquifer must be checked for adequate permeability and absence of polluted areas. The aquifer should be sufficiently transmissive to avoid excessive buildup of groundwater mounds (Bouwer, 2002).

Government has been working to provide Artificial recharging wells. In Cisarua Infiltration wells have been constructed around 201 units. There are 30 units in Batu Layang Village, 30 units in Kopo Village, 39 units in Citako Village, and 82 units in Tugu Selatan Village.

Artificial recharging wells can reduce runoff that effected by deforestation. As we know that Cisarua Sub-district is located in upstream, so that runoff from cisarua can be injected to groundwater. This method can indirectly prevent flood in Jakarta as capital of Indonesia. Hydrogeologic cross section can be seen in Figure 5.



**Figure 4:** Hydrogeologic cross section showing features of the ground water flow system (Modified by Faisi and Titiék)

#### 4. Conclusions

Water shortage for domestic uses and deforestation that have happened in Cisarua Sub district can be solved by rainwater harvesting and infiltration wells. The roof top rain water collected from the roof will be stored into the existing water supply tank of the buildings. About 291480 cum will be recharged during a month and can cover 66.378 % of water demand. The government has been working to provide infiltration wells. In Cisarua Infiltration wells have been constructed around 201 units. There are 30 units in Batu Layang Village, 30 units in Kopo Village, 39 units in Citako Village, and 82 units in Tugu Selatan Village. Artificial recharging wells or infiltration well can reduce runoff that effected by deforestation. This method can indirectly prevent flood in Jakarta as capital of Indonesia because Jakarta is located lower than Cisarua sub district.

#### Acknowledgements

The funding received for this project was from the authors and the authors declare that there is no conflict of interest.



## References

- [1] D. Parwatiningtyas, E.W. Ambarsari, S. Mariko. The Calculation of the Highest Leak Level of Water Pipe Lines Region at PDAM Tirta Kahuripan Using Fuzzy C-Means and ArcGIS Method Analysis. (2017). AIP Conference Proceedings 1862, 030196 (2017); doi: <http://dx.doi.org/10.1063/1.4991300>
- [2] BPS – Statistics of Bogor Region. Bogor regency in figures 2016. Bogor: BPS – Statistics of Bogor Region; 2016
- [3] BPS – Statistics of Bogor Region. Bogor regency in figures 2015. Bogor: BPS – Statistics of Bogor Region; 2015
- [4] Afifah. Analisis inkonsistensi pemanfaatan ruang di kecamatan cisarua, kabupaten bogor dan faktor-faktor yang mempengaruhinya [Thesis]. Bogor: Bogor Agricultural University; 2010
- [5] 8 Fantastic Solutions to Deforestation [Internet]. 2017 [cited 27 Sep 2017]. Available from: <https://www.eartheclipse.com/environment/fantastic-solutions-to-deforestation.html>
- [6] Hossam H. Elewa, Atef A. Qaddah and Ayman A. El-Feel. Determining Potential Sites for Runoff Water Harvesting using Remote Sensing and Geographic Information Systems-Based Modeling in Sinai. American Journal of Environmental Sciences (2012). 8 (1): 42-55.
- [7] A. R. Musa, N. M. Tawil\*, S. M. Sood, A. I. Che-Ani, N. Hamzah, H. Basri. Constructing Formulation of Affordable Green Home for Middle Income Group. Procedia Engineering (elsavier.com). (2011) 466 – 473
- [8] Bouwer, H. Artificial recharge of groundwater: hydrogeology and engineering. Hydrogeology Journal. 2002; 10: 121.
- [9] Government of India Ministry of Water Resources. Manual on Artificial Recharge of Ground Water. New Delhi: Central ground water board ministry of water resources; 2007.
- [10] Fayez A. Abdulla and A.W. Al-Shareef. Roof rainwater harvesting systems for household water supply in Jordan .2008; Desalination 243 (2009) 195–207
- [11] Database of PDAM Kabupaten Bogor (2016)
- [12] Database of BPDAS Citarum-Ciliwung (2013)
- [13] Database of Stasiun Meteorologi Citeko Bogor (2012)
- [14] Harvesting rainwater 2017 [cited 27 Sep 2017]. Available from: <https://harvestingrainwater.ca/rainwater-harvesting/>
- [15] Rezaul K. Chowdhury and Simon Beecham. Characterization of rainfall spells for urban water management. International Journal of Climatology. 2013; 959-967

# Development of Indicators for the Assessment of Social, Economic and Environmental Impacts of Clean Development Mechanism (CDM) Projects in Pakistan with a Case Analysis of Pakistan's First Approved CDM Project

Butt, Ayesha Aftab<sup>1,2,\*</sup>

<sup>1</sup>Department of Environmental Sciences, Faculty of Basic and Applied Sciences, International Islamic University, Pakistan

<sup>2</sup>Department of Projects and Development, Muslim Hands, Pakistan

## Abstract

The aim of this research is to review and develop the indicators which prove to be necessary in assessing the social, economic and environmental impacts of the on-going Clean Development Mechanism (CDM) projects in Pakistan. The study examines missing links, identified through comparative analysis of the on-going projects for the social, economic and environmental criteria. The study identifies the salient impacts of the on-going CDM projects in Pakistan i.e. CERs and generation of carbon credits. It highlights the benefits gained through those projects. The study also explores the potential sectors of CDM projects in Pakistan. It has identified the indicators and provided the means of testing the projects contribution to sustainable development. It is suggested that for any such project, to qualify at least two of the four pillars, namely environmental and social sustainability, must show positive results. The study combines the findings of different studies and communicates well the new tools to understand the evolving environmental factors and evaluate the CDM project performance. There are few literatures available addressing Pakistan's CDM from different perspectives. However, such projects are mostly focused on the methods, research and capacity building but there is a need also to converse the issues of sustainable development criterion and progress towards this aspect. CDM being the new intervention require attention, as great benefits are associated with it and development of indicators to assess the impacts of current CDM projects in Pakistan will actually depict the missing links which will then be focused by future projects and studies. An ultimate conclusion of this research study is the development of the indicators (social, economic and environmental) which provides an indicative answer to the actual research topic.

**Keywords:** Clean Development Mechanism, Indicators, Pakistan, projects

## 1. Introduction

Climate Change is the new emerging global environmental issue nowadays which has drawn the world's attention towards itself. Any changes occurring in the natural environment ultimately affects the human activities and hence effects the growth and development of a country. Global Warming is one the serious environmental problem which has aggravated other environmental problems like water and air pollution, soil erosion and loss of biodiversity as well. It is important to adopt some measures in order to reduce such impacts, improvements therefore is needed in energy efficiency, exploration of renewable energy sources and preservation of forests and agricultural lands prove to be great steps in solving various ecological dilemmas. [1]. Recognizing the consequences of climate change different intergovernmental conferences were being carried out in late 1980s and early 1990s particularly focusing on havoc impacts of climate change and its mitigation options. The Kyoto Protocol came into force in 1997, which is one of the great efforts for the protection of the environment and a step towards achieving the sustainable development. The Kyoto Protocol led to the formulation of 3 market based flexibility mechanisms to mitigate GHGs emissions, one of which is CDM. [2]

Clean Development Mechanism defined as, a tool which allows emission reduction projects that assist in creating sustainable development in developing countries to generate CERs for use by the investor [3]. The CDM is an innovative mechanism which has twin aim of supporting industrialized countries in meeting their GHG emission reduction commitments and assisting the developing countries in achieving sustainable development. CDM is newly emerging policy tools which aim to reduce the emissions all over the world and

---

\* Corresponding author; email: ayesha2@hotmail.com

has a great potential to combat with climate change impacts thus benefit the entire globe. It is important to encourage the CDM projects in order to fulfill the national requirements and cope with problems like poverty, food insecurity and illiteracy. The only way CDM can contribute to sustainable development in developing world is, if the mechanism embraces simultaneously social, economic and environmental responsibility and avoids becoming yet another tool to make the economically richer to be more rich. [4].

The aspect of sustainable development for CDM is not just a condition; it is the prime driver for establishing a country's interest in the development of CDM projects [5]. CDM projects generate number of impacts e.g. social, economic and environmental in the host countries besides the GHG emission reductions. The choice of the Sustainable Development criteria and the assessment of the Sustainable Development impacts are supreme matters of the host countries in the present operationalization of the Kyoto Protocol [5]. Therefore, all national authorities needs to establish the sustainable development dimension in order to assess the connection between national development goals and CDM projects, with intention of selection and designing of CDM projects to create synergy with the development goals of a nation. [6]

## 2. Research Objective

Assessment of sustainable development aspect of CDM projects is a chance for the national authorities to identify potential CDM projects and exploitation of local development synergies. The Designated National Authorities (DNAs) play a significant role in securing the recognition of national development benefits of CDM projects, since they are anticipated to examine the obligation of the CDM to assist Sustainable Development to be fulfilled in host countries [7].

As, Chapter 40 of Agenda 21 calls for the indicators of sustainable development. Agenda requires the countries, international, governmental and non-governmental organizations to develop the idea of sustainable development indicators to identify those in the perspective of CDM project performance. It is the choice of the host Party to verify whether a CDM project activity helps to achieve Sustainable Development goals or not. [8]

Pakistan, being the beneficiary of CDM, has huge potential through the development of these projects in various sectors. For the successful implementation of CDM, Pakistan needs to set up its own sustainable development indicators which may prove to be helpful in the assessment of future CDM projects in the country. Although Pakistan has endorsed host country approval to certain CDM projects and also leading towards Certified Emissions Reductions (CERs) but still there is a need to meet the sustainable development criteria through the development of Sustainable Development Indicators (SDI) to meet the desired goals of effective implementation of future CDM projects and their success in Pakistan as well as globally. This study will thus lead towards the following objectives;

- 1) Development of sustainable development indicators in Pakistan's context,
- 2) Assessment of sustainability of an on-going CDM project in Pakistan and,
- 3) Identification of missing gaps and possible recommendations.

## 3. Materials and Methods

### Study Protocol

The research methodology handled the data in two main steps; Data Collection and Data Analysis. Data (qualitative / quantitative) was collected from different primary and secondary sources such as; literature reviews, series of interviews, meetings, field visits, focus group discussions, interviews, brain storming sessions with CDM experts, different events / conferences. It included; Meetings with relevant ministries (Ministry of Environment, Ministry of Industries, Ministry of Water and Power), International Organizations working on CDM projects implementation in Pakistan, Meetings with the CDM registered project proponents i.e. Pak Arab Fertilizer Limited (1<sup>st</sup> CDM approved project of Pakistan by UNFCCC), Brain storming sessions during field/site visit. Certain questions were also raised to reach towards the end objective of the study. The following sub questions were further developed regards current status of CDM in Pakistan and its promotion, possible barriers in implementation faced by industries and recommendations for effective implementation of such projects in the country.

### Data Collection

In recognition of the situation, five specific tasks were identified/ highlighted in the project study including; Integrative review and analysis of CDM in Pakistan, Identification of the potential for CDM in Pakistan particularly in the potential sectors mentioned in the National CDM Strategy, Evaluation of the CDM performance in Pakistan and the sustainable development assessment of CDM projects in Pakistan, Development of the indicators for assessing the social, economic and environmental impacts of CDM projects in

Pakistan and Analysis of the sustainability criteria employed for the 1<sup>st</sup> CDM approved project, Pak Arab Fertilizer Multan in Pakistan.

The first step of data collection highlighted the background of the CDM approach in accordance with the sustainable development objectives. Various methods were used for the entire study; integrative review of CDM in Pakistan's context was based on the latest appropriate information obtained through review of literature and sequential progressive interviews conducted. Literatures included the scientific journals, research project reports, publications, Project Design Documents (PDDs), conference papers and presentations as well as up-to-date information from Ministry of Environment, CDM Cell website. The statistical data came from authoritative publications (ministries, international organizations, private sector working on CDM projects), formal interviews were taken (personally or via email). Some of the interviewees gave well-timed response to the project findings. Information related to CDM and Climate Change was collected by attending seminars, conferences and workshops on the subjects of CDM financing, Carbon Credit opportunities in power, renewable energy, waste management etc. conducted by different private, international and government organizations working on CDM project development in Pakistan like Winrock International, CDM Cell-Ministry of Environment, UNIDO, Carbon Services etc. The consequent interactions enhanced the sources of information and shaped further discussions. Comparative approach was also used in the study as well. Assessment of the Pak Arab Fertilizer, Multan project (1<sup>st</sup> CDM registered project of Pakistan) was carried out against the set defined indicators in the Gold Standard Manual. Degree of success was assessed in terms of meeting up of the criteria of sustainable development (social, economic and environmental).

#### Tools Devised

A close and open ended questionnaire was developed on the basis of standardized gold indicators and indicators extracted from the PDD for the assessment of social, economic and environmental impacts generated by the CDM project of Pak Arab Fertilizer Limited (PFL). The questionnaire highlighted the three criterions (social, environmental and economic) for the assessment of CDM project impacts. The questionnaire was discussed with the project officials and filled. Questions mentioned in the questionnaire were related to the current status of the project, benefits gained by the community through the project, economic wellbeing of the country and environmental wellbeing of the particular area where the project was operational. The questionnaire has helped in determining the missing links which were addressed by the study. The secondary data was also collected through different sources particularly from the studies already concluded and Ministry of Environment, DNA.

#### 4. Results and Discussions

The study chiefly led towards devising a set of sustainable development indicators in Pakistan's context, the same set is then used to assess the sustainability of an on-going CDM first approved project in Pakistan. Alongside, the study revealed the gaps identified and possible recommendations for effective implementation of the model in developing country's context.

4.1. Prioritized Sustainable Development Indicators and Scaling: The ultimate outcome of the study is the list of sustainable development indicators addressing 3 main pillars i.e. social, economic and environmental particularly. A relative scale has also been provided for the assessment of the indicators. The list of indicators developed for the assessment of CDM projects in Pakistan clearly highlights the most important aspects which should be addressed properly for a developing country like Pakistan. The list of indicators defined under the criterion as highlighted in the given table;

**Table 1** Proposed Set of Indicators for the Assessment of CDM projects sustainability of Pakistan

CRITERIA	INDICATORS
ENVIRONMENTAL	Reduction of greenhouse gas emissions compared with baseline (CO <sub>2</sub> equivalent)
	Emission of air pollutants compared with baseline
	Noise level in the project site
	Odor Pollution
	Waste water quality
	Waste output of the project per raw material input
	Soil contamination in compliance with government standards
	Ground water contamination

CRITERIA	INDICATORS
	The amount of hazardous waste
	The project's water demand and efficiency of water usage
	Soil, coastal and river bank erosion in the project site
	Green Areas
	The impact on ecosystem diversity and biodiversity
	Population size and species of flora and fauna
SOCIAL	People's participation, sensitization, education
	Projects or activities based on sufficiency economy philosophy, Protection of natural and cultural heritage, Scholarship awards, Religious, arts and cultural activities, Healthcare support, Child nursery care, living standards, Supplying drinking water etc.
	Workers' health and surrounding community health
	Generation of Employment Opportunities
TECHNOLOGICAL	Development/import of technology
	Number of well skilled employees
	Post Crediting Period plan as outlined by the project
ECONOMIC	Workers' annual income
	Energy. Consumption, Production Use of alternative energy or energy efficiency (percentage %) Use of alternative energy / domestic renewable energy (tons of oil equivalent) Percentage of energy usage efficiency
	Provision of infrastructure and procedural requirements.

Keeping in view, the situation of a developing country like Pakistan, environment is the neglected area as compared to the social and economic criteria. In case of CDM projects (On-going and new project proposals) indicators provided prove to be useful as each criteria is addressed separately.

In contrast to the existing literature of the sustainability assessment of CDM projects such as MATA-CDM (Multi-Attributive Assessment of CDM projects) approach which is been defined under Kyoto Protocol and applicable to assess the sustainability of all international CDM projects, this study has focused on a specific perspective of development of indicators for the assessment of sustainable CDM projects of Pakistan. The set of proposed indicators resulted from the study are totally in compliance with the National Sustainable Development Strategy (NSDS) of Pakistan and addresses separately the environmental, social and economic challenges associated with the CDM projects which may hinders the sustainable development of the country. It is important to carry out the assessment of sustainable development benefits of CDM projects applicable to the future CDM projects also. The easiest way is the application of a uniform checklist which considers different parameters against the defined scale. Different identified indicators can be calculated using the standardized values given in Table No. 7 indicating the values from -1 to 3.

**Table 2** Assessment scale for determination of the Sustainable Development benefits of CDM projects

SCALE Value	SIGN	INDICATOR
-1	Negative	Project has negative sustainable development impacts. Negative impacts generated in terms of environmental and social development (ESD) policies and/or causing environmental/social impacts from the CDM project baseline.
0	Neutral	Sound CDM project having no difference from baseline in any of environmental/social or policy terms
1	Positive	One additional significant benefit e.g. one of social, local, environmental, health, poverty, community participation or economic/welfare gains.
2	Positive	Two or more additional benefits in two categories. i.e. social, environmental and economic
3	Positive	Significant benefits in three or more categories i.e. social, local, environmental, health, community participation and welfare/employment.

Proposed Set of Indicators for the assessment of Social, Environmental and Economic Impacts of CDM Projects in Pakistan: Pakistan being a developing country and a new entrant to the CDM business needs to develop the guidelines and the indicators for review and approval of CDM projects according to national sustainability goals. Sustainable development including technical and institutional infrastructural are required to be raised to an increased stage in order to evaluate the projects qualifying for CDM. All CDM projects need to demonstrate progress in all three pillars of sustainable development (environmental, social, and economic) as well as sustainable technological indicators.

**Table 3** Set of Indicators for Assessing impacts of new and ongoing CDM projects in Pakistan

CRITERIA	INDICATORS	NEW CDM PROJECT PROPOSAL (PDD)	ONGOING CDM PROJECT
ENVIRONMENTAL			
1) Reduction of greenhouse gas emissions	Reduction of greenhouse gas emissions compared with baseline (CO <sub>2</sub> equivalent)	0 Greenhouse gas emissions are equivalent to baseline +1 Greenhouse gas emissions are reduced	- 1 Increase in greenhouse gas Emissions 0 Greenhouse gas emissions are equivalent to baseline +1 Reduction of greenhouse gas emissions less than 10% by year +2 Reduction of greenhouse gas emissions by 10% and more by year
2) Reduction of air pollutant emissions in compliance with air quality standards Note: Standards concerning air pollutants should be in compliance with the laws of Ministry of Environment, EPAs, Pollution Control Departments etc.	Emission of air pollutants compared with baseline	-1 Increase in emissions of air Pollutants 0 Emission of air pollutants is equivalent to baseline +1 Reduction of air pollutant emissions	-1 Increase in emissions of air Pollutants 0 Emission of air pollutants is equivalent to baseline +1 Reduction of air pollutant emissions less than 20% by year +2 Reduction of air pollutant emissions by 20% and more by year
3) Noise pollution (in compliance with government standards announced by EPAs such as NEQs)	Noise level in the project site	0 Noise level meets standards +1 Noise level below standards	-1 Noise level exceeds standards 0 Noise level meets standards +1 Noise level below standards by 10 Decibel or less +2 Noise level below standards more than 10 decibels
4) Odor pollution (in compliance with government standards)	Odor pollution	0 Meets standards +1 Below standards	-1 Exceeds standards 0 Meets standards +1 Below standards +2 Odorless
5) Wastewater quality (According to set effluent standards)	Wastewater quality	0 Wastewater quality meets standards +1 Wastewater quality is below standards +2 Wastewater quality is below standards and wastewater discharge decreases	0 Wastewater quality meets standards +1 Wastewater quality is below Standards +2 Wastewater quality is below standards and wastewater discharge decreases +3 Zero discharge of wastewater/treated wastewater

		+3 Zero discharge of wastewater/treated wastewater	
6) Waste management	Waste output of the project per raw material input	-1 Increased waste output per raw material input 0 Waste output per raw material input remains intact +1 Reduction of waste output per raw material input +2 Zero flow of waste	-1 Increased waste output per raw material input 0 Waste output per raw material input remains intact. +1 Reduction of waste output per raw material input +2 Zero flow of waste
7) Soil Contamination	Soil Contamination in compliance with government standards	0 No soil contamination +1 Rehabilitation of soil quality	-1 Creating soil contamination 0 No soil contamination +1 Rehabilitation of soil quality
8) Groundwater contamination	Groundwater contamination	n/a Not applicable to the new proposals	-1 Groundwater contaminated 0 No groundwater contamination
9) Reduction of hazardous waste Note: Hazardous waste should be in compliance with laws announced by relevant ministries and authorities.	The amount of hazardous waste	-1 The amount of hazardous waste increases 0 The amount of hazardous waste remains intact +1 The amount of hazardous waste decreases.	-1 The amount of hazardous waste increases 0 The amount of hazardous waste remains intact +1 The amount of hazardous waste decreases
10) Water demand and efficiency of water usage	The project's water demands and efficiency of water usage	-2 Water usage impacts water resources and creates other environmental impacts in the water basin. -1 Water usage impacts water resources. Water usage per production unit increases. 0 Water usages does not impact water resources nor create environmental impacts in the water basin. +1 Self-contained water storage +2 Self-contained water storage and decrease of water usage per unit.	-2 Water usage impacts water resources and creates other environmental impacts in the water basin. -1 Water usage impacts water resources. Water usage per production unit increases. 0 Water usages does not impact water resources nor create environmental impacts in the water basin. +1 Self-contained water storage +2 Self-contained water storage and decrease of water usage per unit.
11) Soil, coastal and river bank erosion.	Soil, coastal and river bank erosion in the project site	n/a Not applicable	-1 Soil, coastal/river bank erosion caused by the project's activities 0 No soil, coastal and river bank erosion caused by the project activities.

			0 No soil, coastal and river bank erosion caused by the nature due to impact of project activities.
12) Increase in green areas under the project's initiative.	Green areas	0 The project does not develop green areas. +1 The project develops green areas. +2 The project develops green areas above the average of provincial statistics. +3 The project develops green areas above the average of provincial statistics and does not pollute landscape.	0 The project does not develop green areas. +1 The project develops green areas. +2 The project develops green areas above the average of provincial statistics. +3 The project develops green areas above the average of provincial statistics and does not pollute landscape.
13) Ecosystem diversity	The impact on ecosystem diversity and biodiversity	-1 Impact on ecosystem diversity and biodiversity. 0 No impact on ecosystem diversity and biodiversity. +1 Increase of biodiversity to the ecosystem.	-1 Declined biodiversity in the ecosystem. 0 The ecosystem remains intact. +1 Increase of biodiversity to the ecosystem.
14) Species diversity	Population size and species of flora and fauna	-1 Decline in population size and species of flora and fauna. 0 Flora and fauna species remain intact. +1 Increase in flora and fauna species.	-1 Decline in population size and species of flora and fauna. 0 Flora and fauna species remain intact. +1 Increase in flora and fauna species.

#### 4.3 Assessment of Sustainability of an On-going CDM project of Pakistan

During the field visit of the On-going CDM project i.e. PFL Project Multan, assessment has been made on the basis of the indicators extracted from the Gold Standard Manual typically being used for assessing the performance of the CDM projects. The scale values would be like;

- 0 -- Neutral (Sound CDM project with no significant benefits nor loss)
- +1-- Positive (One additional significant benefit e.g. one of social, local, environmental and economic).
- +2 – Positive (Two or more additional benefits in two categories. i.e. social, environmental and economic).
- +3 – Positive (Significant benefits in three or more categories i.e. social, local, environmental, health, community participation and welfare/employment).
- -1 – Negative (Negative impacts generated in terms of environmental and social development policies and/or causing environmental/social impacts from the CDM project baseline).

The following table shows the rating against the defined scale for the assessment of CDM project impacts for the PFL project Multan.



**Table 4** Rating of Pak Arab Fertilizer (PFL) Project Impacts

THEME	INDICATORS	SCALE	BENEFITS
SOCIAL	Contribution to net employment generation	+1 -- Positive	Social
	Equal employment opportunities	0 -- Neutral	-
	Social security of work force	+2 – Positive	Social (health) Economic
	Capacity building of staff and learning	0 -- Neutral	-
	Education	+1 -- Positive	Social
	Improved quality of life	+2 –Positive	Social/ Environmental
ECONOMIC	Contribution to sustainability of the balance of payments	+2 –Positive	Economic/ Environmental
	Cost effectiveness	+1 – Positive	Economic
	Contribution to macroeconomic sustainability	+1 -- Positive	Economic
	Reduction of direct government investments	0 – Neutral	-
	Net foreign currency savings	+1 -- Positive	Economic
ENVIRONMENTAL	Air quality	+1 --Positive	Environmental
	Avoided emissions of local pollutants	+1 --Positive	Environmental
	Other Pollutants	+1 --Positive	Environmental
	Biodiversity	Not applied	-

## 5. Conclusion & Recommendations

Pakistan is a developing nation with problems like diminutive geographic area and burdened with population, political insecurity, resource constraints, unemployment, poverty and environmental problems. In this regard, implementation and development of CDM projects is vital. Environmental well-being can be achieved through execution of maximum number of CDM projects which helps in overcoming the problems like energy crisis, health hazard and economic instability. CDM projects development in Pakistan has faced several restrictions since its initiation. The major gaps identified in the CDM projects implementation in Pakistan are as follows;

- There is a lack of baseline data. A well-defined baseline should be established taking into consideration the opinions of country's experts and all concerned government, non-government and international organizations.
- There is a Low level of awareness amongst the public, private and financial sectors about CDM procedures and opportunities are the underlying obstacles to CDM's thrive in Pakistan. Awareness raising and dissemination of information should be carried out properly through seminars, workshops, trainings and advertisement.
- Pakistan lacks optimum funds in the CDM operation, in this regard government should mobilize the entrepreneurs through motivation and the banking sector should be called for raising fund for the CDM projects development. There is a need that the Board of Investment should convince foreign investors to set up projects with 100 per cent equity or in the form of joint ventures on the basis of CDM arrangements.
- There is low Capacity level of public and private institutions. It is important to build the capacities of the officials of these institutions particularly the staff of DNA through information dissemination and also to draw the attention of donor agencies and other foreign investor through participation in trade fairs, exhibitions, international workshops and websites of other national institutions. CDM project approval process is quite complex in Pakistan. Industrial stakeholders are not satisfied with the procedure of host country approval and they are of the view that the concerned government officials are not properly providing guidelines to complete the required procedure. In order to overcome this problem country like Pakistan should apply to the CDM Executive Board to relax and simplify the process for the sake of smooth growth of CDM in the

whole developing world. Proper guidelines for the preparation of PDD and all other related stuff must be made readily available on net for preparation of reports and studies otherwise stakeholder is bound to hire consultant services which may prove to be expensive.

- There is a gap in the understanding of the involvement of academic institutions in the CDM project development. In this regard, the academic institutions and consulting firms should be taken on board for their technical skills enhancement in order to provide technical resources in Pakistan for CDM project development and to address the projects' sustainability issues in a best way.
- The government alone however, cannot alleviate the seriousness of threat to sustainable development in Pakistan. It demands urgent action by all segments of society including the Government, private sector, NGOs and civil society at large. The government should take the lead in initiating the action through promoting participation for ownership of policies, programmes and projects and enforceability of laws and regulations.
- For carrying out the sound sustainable development activities/projects in Pakistan and to make NSDS effective it is important to devise an appropriate institutional mechanism for its implementation and monitoring. NSDS is multisectoral in nature, in this matter Government should constitute a multisectoral body which should not only plan, monitor or supervise the implementation of NSDS but also motivate the key stakeholders with a stake in a prosperous future of Pakistan, in its implementation and may also serve the purpose provided its mandate and membership is broadened in line with all three aspects of sustainable development i.e. economic, social and environmental dimensions.

This study has also provided a ground for the further research on how these indicators could be refined more in order to be used for the assessment of CDM projects according to the national priorities and project specific indicators could also be proposed. The future studies may also focus on the Development of a success criteria including Sustainable Development Indicators by assessing the projects through the DNA with the help of UNFCCC. To make this effective a Sustainable Development Unit could be established under the DNA to work on this special perspective of Sustainable Development. Further research to be carried should also need to focus on the following;

- Research into the need of Institutional Arrangements: - For the Developing nations say Pakistan like to host CDM projects need to put in place the necessary institutional mechanisms for approving CDM projects and ensuring their compatibility with national sustainable development goals and strategies.
- Need for financial arrangements: - There is a need for sufficient financial arrangements into the CDM sector in order to promote the associated sustainable (social, economic and environmental) benefits arising from these projects.
- It is needed to know how much sustainable development could be possible through CDM projects for the developing countries.

Sustainable development is not actually a requirement but should be considered as an important aspect in CDM scheme. For the developing countries like Pakistan CDM should be examined both at policy and implementation levels and the success stories of the advanced civilizations prove to be effective in this regard.

### Acknowledgements

The author would like to extend special thanks to the department of environmental sciences, international Islamic university, Islamabad, Pakistan for providing the baselines and technical inputs to the study, moreover the CDM unit of United Nations Industrial Development Organization (Pakistan) providing ways of enriching the research with up-to-date information.

### References

- [1] Olhoff et al. (2007) CDM Sustainable Development Impacts Guide, CD4CDM UNEP Project
- [2] UNFCCC (2015) Web link: [http://unfccc.int/kyoto\\_protocol/items/2830.php](http://unfccc.int/kyoto_protocol/items/2830.php)
- [3] Rosales, J. and G. Pronove (2002) A Layperson's Guide to the Clean Development Mechanism. UNCTAD-Earth Council
- [3] Pembina Institute for Appropriate Development (2003) A User's Guide to the Clean Development Mechanism (CDM) – Second Edition.

- [4] Liguang, L. (2006) Seeking synergies to achieve sustainable development. Clean Development Mechanism in China. Master Thesis, Masters of Science Programme, Jinan University, China
- [5] Verles, M. (2016) Sustainable Development from Kyoto to Paris and Beyond
- [6] Curnow, P. (2009) A guidebook to host country legal issues
- [7] CDM cell, Ministry of Environment, Pakistan (2006), Pakistan National Operational Strategy for CDM
- [8] UNIDO (2009), Institutional Capacity Enhancement for CDM in Pakistan, Research Study carried out by UNIDO and Ministry of Environment, GOP (Report Unpublished)
- [9] Agenda 21, Chapter 40: Information for Decision-making. (Advanced version of chapter 40 of Agenda 21, as adopted by the Plenary in Rio de Janeiro, on June 14, 1992) weblink: [gopher://unepq.unep.org:70/11/un/unced/agenda21](http://gopher://unepq.unep.org:70/11/un/unced/agenda21)

# Comparison data inventory of two limestone quarries with environmental footprint technique

Thanapat Atikij<sup>1</sup>, Sayam Aroonsrimorakot<sup>1,2\*</sup>

<sup>1</sup>Department of Appropriate Technology and Innovation for Environmental Security, Faculty of Environment and Resource Studies, Mahidol University, Salaya, Nakornpathom 73170, Thailand

<sup>2</sup> Associate Professor of Faculty of Environment and Resource Studies, Mahidol University

## Abstract

Limestone has been very popular in using as a raw material to construct almost every industries and commonly found in every part of Thailand through quarrying. This study analyzed the resources, power and material consumption in limestone's production process from 2 quarries in Thailand. In short, the quarries will be called limestone quarry A and limestone quarry B. The analysis is based upon the production process in 2016 by using Life Cycle Assessment to consider the resources, power and material consumption as an input in Data Inventory to compare each other based on 1 ton of limestone production. From the study, the production process of both quarries is similar only the consumption is difference. The production process including (1) Preparing and Drilling (2) Blasting (3) Excavating (4) Transporting (5) Milling. The resources used in production process including fuel, electricity and ammonium nitrate while limestone quarry A also use electricity and water in blasting process, limestone quarry B does not. According to the calculation limestone quarry A consumed fuel 0.650 liter/ton while limestone quarry B consumed 0.345 liter/ton the difference is 0.305 liter/ton or 46.92% most of the fuel were consumed in Excavating process. Limestone quarry A consumed electricity 4.164 kWh/ton while limestone quarry B consumed 1.154 kWh/ton the difference is 3.010 kWh/ton or 72.29%. Ammonium nitrate consumption of limestone quarry B was 0.221kg/ton while limestone quarry A is 0.007 kg/ton the difference is 0.214kg/ton or 96.83%. In addition, limestone quarry A also consumed water in production process 9 liter/ton. A result of difference caused by the technology gap while limestone quarry A uses a simple and straight forward technology, limestone quarry B uses an advance technology to carry the manufacturing process.

**Keywords:** Life Cycle Assessment, Environmental impact, Environmental Footprint, Limestone quarry

## 1. Introduction

Environmental impact and damage has increasingly been getting attention from people around the world as the relation and consequences between living and non-living, natural-made and man-made in the environment becomes more visible. Meanwhile, natural resources such as renewable resources including wind, tide, sunlight, forest and animal and non-renewable resources including minerals, fuel and soil are decreasing. The environmental impact and the expansion of society, economy and population, mismanagement and improper technologies are one of the causes of the depletion of those resources. Furthermore, it also create more impact to system such as air pollution, acid rain, greenhouse effect, ozone depletion and resources run down which may lead to further conflict in the future.

Limestone or Calcite ( $\text{CaCO}_3$ ) is a sedimentary rock, composed mainly of skeletal fragments of marine organisms such as coral, forams and molluscs. Its major materials are the minerals calcite and aragonite, which are different crystal forms of calcium carbonate. Limestone physically appears as a dense white-grey stone. As mentioned above, limestone is a byproduct of a slow and long geological process, more importantly it is a non-renewable resource. Somehow, from its commonly found across the country and constant quality, Limestone has numerous uses as a building material, an essential component of concrete (Portland cement), as aggregate for the base of roads, as white pigment or filler in products such as toothpaste or paints, as a chemical feedstock for the production of lime, as a soil conditioner, or as a popular decorative addition to rock gardens. Limestone quarry usually uses medium to large machine with high amount of investment, the process can be broken down as follow (1) Design and Preparation (2) Drilling and Blasting (3) Excavating and Transporting and (4) Processing for product's purpose. The processing usually use Jaw crusher as a Primary crusher before feed the material to the Second crusher, Tertiary crusher also include in some high demand factory to create more fine ground limestone. The grounds then conveyed through strainer to separate the stone

\*Corresponding author; e-mail: sayam.aro@mahidol.ac.th

by size for further process. Limestone's manufacturing process relies on technologies to achieve high quality with optimum price which make it become a large scale industry. As result, the impact of this industry can be separated in 2 categories 1) non-renewable resources depletion impact and 2) environmental and human health impact [1], [2] such as deforestation from land slide that affect agricultural product and biodiversity [3], water contamination from manufacturing's chemical byproduct [4], air pollution by produce CO<sub>2</sub>, CO, NO<sub>x</sub>, So<sub>x</sub>, CH<sub>4</sub>, NMVOCs and NH<sub>3</sub> [5], noise and dust pollution with 25-50 µm dust (Total suspended particles, TSP) [6] that affect community and human hygiene such as Pulmonary disease or Silicosis asbestosis [7], Eutrophication on land caused by a contamination from mining process and lead to an increasing soil basicity that affect plants and biodiversity [8].

As mentioned before, limestone can be commonly found across Thailand with 325 sources cover 56,803 acre. Limestone industry is a massive mineral industry in Thailand with high product value and high demand in cement, construction material, chemical and agricultural industry. Limestone has also been manufactured enough to export to other countries. On the other hand, the tremendous amount of demand and manufacturing also cause a conflict between community and manufacturer in many regions [9]. As the demand for limestone in construction material industry is still increasing [10], the limit of management and development process to reduce the effect from quarry become more strict [11]. Data collection is also one of the methods to give a better understanding of the industry in a bigger picture and better evaluation.

Environmental footprint technique is still new in Thailand while it is well-known in Europe, few Thai research is done with this technique. The technique accumulates 14 environmental impact factors and calculate a footprint as result [12]. This technique has been published recently by the announcement from European commission. The announcement aim to set a standard for international trade, green product focus on improve its quality and environment friendly which will be evaluated by Life Cycle Assessment (LCA). LCA is an assessment technique according to ISO 14044 [13] to assess the impact of product throughout its life cycle in form of energy consumption, material and waste from extracting its raw material through transportation, usage and end of use period also known as cradle-to-grave analysis [14]. Information from the assessment can be used as an index to seek new approach in managing each product to be more environmental friendly.

This study aims to assess the impact from limestone manufacturing process in Thailand from 2 different manufacturer using LCA technique to evaluate the consumption of resources, energy and raw material from the beginning through the end of the manufacturing process. The data obtained this study started from (1) Preparation from Drilling (2) Blasting (3) Excavating (4) Transporting (5) Milling process, recorded in volume to create Inventory data. Finally, by using Environmental footprint technique with the Inventory data, a new approach to manage the manufacturing process and reduce environmental impact can be obtained.

## 2. Research objectives

- 2.1 To study limestone manufacturing process using LCA technique.
- 2.2 To analyze and compare data inventory of the resources, power and material consumption in limestone's production process from 2 quarries.

## 3. Materials and methods

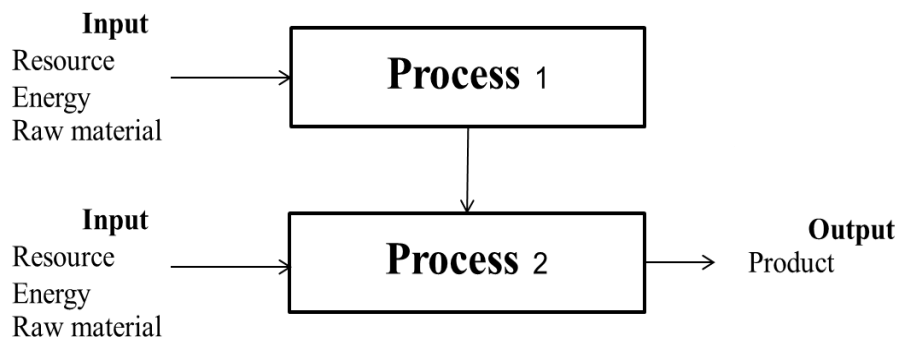
This study adopted Life Cycle Assessment to assess the environmental impact in the form of volume of resources, energy and raw material consumption in limestone manufacturing process of both limestone quarry A and limestone quarry B. The purpose is to get the bigger picture of the manufacturing process and obtain a new approach to improve environmentally friendly manufacturing process.

### 3.1 Goal and Scope Definition

The scope of this study is to collect a data involve's the limestone manufacturing process to calculate resources, energy and raw material consumption per 1 ton of limestone (1 functional unit). The data is only direct to manufacturing process from Preparation through Drilling, Blasting, Excavating, Transporting and Milling process known as Cradle-to-Grave and not include other functional areas of the business such as administration, office building and facilities. The period of data collection started from January to December 2016.

### 3.2 Life Cycle Inventory

Data collection involves environmental impact in each process as indicated in Goal and Scope Definition to define Input including resources, energy and raw material. Meanwhile, output is shown in Figure 1.



**Figure 1** Input and Output of activities

This study collects the volume of Input and Output of each activity from both quarries to compare resources, energy and raw material consumption in manufacturing process including, fuel (liter/ton), electricity (kWh/ton), water (liter/ton), ammonium nitrate (kg/ton).

### 3.3 Environmental impact analysis

Analysis will be done based on resources, energy and raw material consumption in manufacturing process to prioritize the volume of resources and energy consumption in each process. Assess the impact on environment, information will be sorted by descending order.

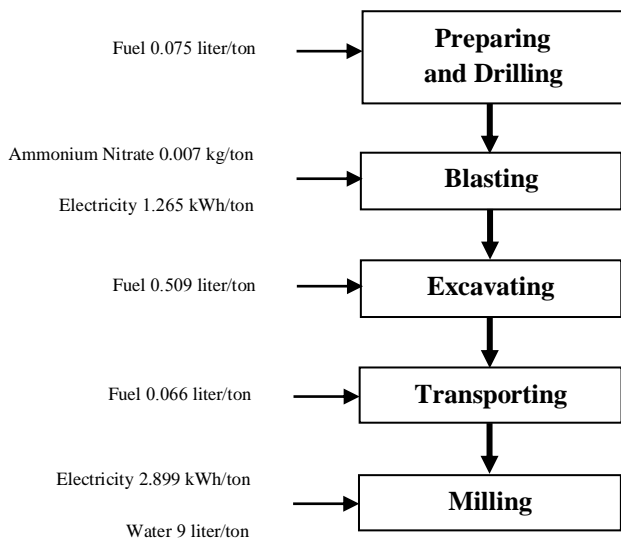
## 4. Results and discussion

From the study, the production process of both quarries is similar including (1) Preparing and Drilling (2) Blasting (3) Excavating (4) Transporting (5) Milling. By calculating resources and energy consumption based on 1 functional unit (Table 1), the result shows that limestone quarry A has consumed resources, energy and raw material consumption, as shown in Figure 2, and limestone quarry B has consumed resources, energy and raw material consumption, as shown in Figure 3.

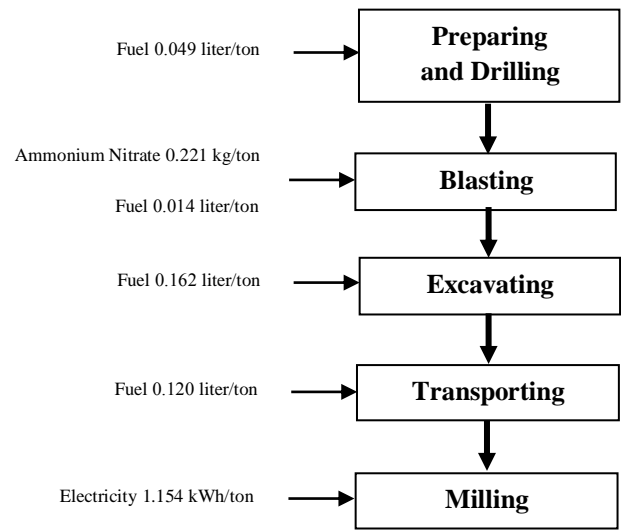
**Table 1** A Consumption of resources, energy and raw material of Limestone quarry A and B

Process	Preparing and Drilling		Blasting		Excavating		Transporting		Milling	
	A	B	A	B	A	B	A	B	A	B
<b>Input</b>										
<b>Fuel</b> (liter/ton)	0.075	0.049	-	0.014	0.509	0.162	0.066	0.120	-	-
<b>Electricity</b> (kWh/ton)	-	-	1.265	-	-	-	-	-	2.899	1.154
<b>Ammonium Nitrate</b> (kg/ton)	-	-	0.007	0.221	-	-	-	-	-	-
<b>Water</b> (liter/ton)	-	-	-	-	-	-	-	-	9	-

While the overall production process of both quarries is similar, the consumption level and input in some process is different. In the Blasting process of limestone quarry A consumed electricity from a water pump in front of the quarry to suck out the water in rock layer to the adjoining reservoir. Meanwhile limestone quarry A has used tap water to wash the crushers, limestone quarry B has used water from the reservoir next to the quarry.



**Figure 2** A flowchart illustrates resource, energy and raw material consumption of limestone quarry A manufacturing process



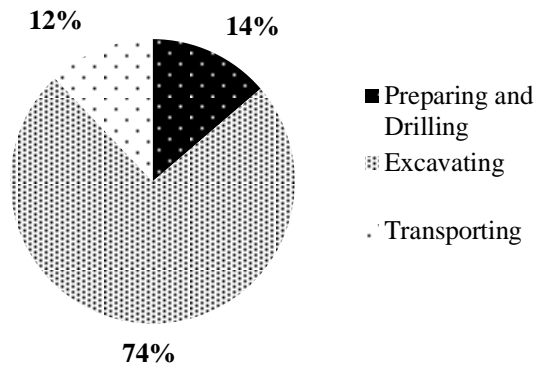
**Figure 3** A flowchart illustrates resource, energy and raw material consumption of limestone quarry B manufacturing process

From the study, the manufacturing inputs of limestone quarry A including fuel, electricity, ammonium nitrate and water. Fuel has consumed by vehicle in Preparation, Drilling, Excavating and Transporting process by the amount of 0.650 liter/ton. Sort by descending order the result are as follow, Excavating consumed 0.509 liter/ton or 78.31%, Preparation and Drilling consumed 0.075 liter/ton or 11.54% and Transporting consumed 0.066 liter/ton or 10.15%. Meanwhile, Blasting and Milling process consumed electricity by 4.164 kWh/ton can be separated as, Milling consumed 2.899 kWh/ton or 69.62% and Blasting consumed 1.265 kWh/ton or 30.38%. Ammonium nitrate has been used as a mixture to make a bomb in Blasting Process by 0.007 kg/ton. Finally, water consumed in the process by 9 liter/ton.

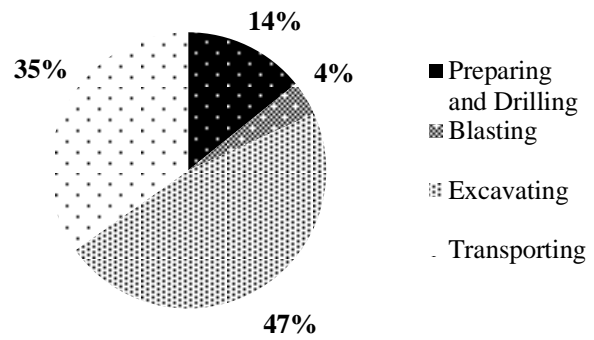
The manufacturing inputs of limestone quarry B including fuel, electricity, ammonium nitrate and water. Fuel has consumed by vehicle in Preparation, Drilling, Blasting, Excavating and Transporting process by the amount of 0.345 liter/ton. Sort by descending order the result are as follow, Excavating consumed 0.162 liter/ton or 46.96%, Transporting consumed 0.120 liter/ton or 34.78% and Blasting consumed 0.014 liter/ton or 4.06%. Meanwhile, Milling is the only process consumed electricity by 1.154 kWh/ton. Ammonium nitrate has been used as a mixture to make a bomb in Blasting Process by 0.221 kg/ton.

Both quarries consumed fuel most in Excavating process. Next, while limestone quarry A spent its fuel in Preparation and Drilling follow by Transportation, as shown in Figure 4, limestone quarry B spent its fuel in Transportation, Preparation and Drilling follow by Blasting, as shown in Figure 5. Comparing both quarries' consumption limestone quarry A consumed 0.650 liter/ton while limestone quarry B consumed 0.345 liter/ton, the latter has consumed 0.305 liter/ton or 46.92% less.

Limestone quarry A consumed electricity in Blasting and Milling process in 4.164 kWh/ton total and 2.899 kWh/ton in Milling. Limestone quarry B consumed electricity only in Milling process in 1.154 kWh/ton. Comparing both quarries' consumption the latter has consumed 3.010 kWh/ton or 72.29%



**Figure 4** A Proportion of Fuel consumed in Limestone Quarry A



**Figure 5** A Proportion of Fuel consumed in Limestone Quarry B

On the other hand, limestone quarry A consumed ammonium nitrate in 0.007 kg/ton while limestone quarry B consumed 0.221 kg/ton. As result, limestone quarry A consumed 0.214 kg/ton or 96.83% less.

Both quarries have a similar manufacturing process from Preparation and Drilling through Blasting, Excavating, Transportation which traveled 0.8 km from quarry to crusher, and occupied 3 crushers for both quarries. The factors that affect the different in consumption is the different in size of the location, manufacturing technology, size of the organization. Limestone quarry A occupied 95,824 sq.m. of production quarry while limestone quarry B occupied 1,023,800 sq.m. Transportation under limestone quarry A belonging is 21 can be separated as 2 Driller, 1 Fertilizer Mixing car, 1 Tractor, 10 Excavator and 7 Dumper while limestone quarry B has 42 can be separated as 12 Driller, 12 Dozer and 18 hundred-tons Truck. Besides, limestone quarry A produces 6 different sizes of product including 1 inch, 2 inch, ¾ inch and 3/8 inch stone plus crushed rock and dust stone. After all 3 crushers finished with all 6 different products and the manufacturing process end, the customers then pick up their goods at the pickup point. On the other hand, limestone quarry B produces only 1 inch stone which will be conveyed through the conveyer to the rest point before transfer to a cement manufacturing process in the other section of the plant in the future.

### 5. Conclusions

The study and data collection of limestone manufacturing process in 2016 has been carried out with Life Cycle Assessment technique to compare resources, energy and raw material consumption in manufacturing process per 1 ton of limestone. From the study, the production process of both quarries is similar including (1) Preparing and Drilling (2) Blasting (3) Excavating (4) Transporting (5) Milling. The only difference between two quarries is the amount of resources, energy and raw material consumption. Limestone quarry A's input including, fuel for Driller, Fertilizer Mixing car, Tractor, Excavator and Dumper during the Preparation and Drilling process through Excavating and Transporting process. Electricity is another input for Blasting, water pump system and Milling process. In addition, Ammonium nitrate is an input for the explosive material in Blasting process. Finally, water is also counted as an input for washing the crushers. Meanwhile, limestone quarry B's input including, fuel for Preparation and Drilling, Blasting, Excavating and Transporting process. Electricity consumed in Milling process and ammonium nitrate in the Blasting process. The analysis shows that limestone quarry B consumed 0.305 liter of fuel and 0.3010 kWh/ton less than limestone quarry A. On the contrary, limestone quarry A consumed ammonium nitrate 0.214 kg/ton less than limestone quarry B. In addition, limestone quarry A has used water in the manufacturing process. The difference in the consumption is caused by the area while limestone quarry A occupied size 95,824 sq.m of production quarry, limestone quarry B occupied 1,023,800 sq.m. Moreover, the difference in number of vehicle and technologies also caused the gap. In addition, the difference in number of product while limestone quarry A produces 6 different sizes of product including 1 inch, 2 inch, ¾ inch and 3/8 inch stone plus crushed rock and dust stone, limestone quarry B produces only 1 inch stone. Finally, while limestone quarry A sells those products to end customers, limestone quarry B uses its product in other section of its own business. As a result of the study in both manufacturing process by using Life Cycle Assessment to obtain information for Environmental footprint technique. A new approach to manage the manufacturing process through technologies, ideas and concept to reduce environmental impact can be obtained. Besides, information from the study can be used to compare with other similar quarry.



## Acknowledgements

This study was cooperated enthusiastically with both quarries to obtain in-depth information for the study within Life Cycle Assessment concept.

## References

- [1] Adepoju SO. Time effect of organic matter accumulation in restored surface layers of limestone mining site. Nigeria. **J. of Engi. Manag.** 2002; **33**: 35-40.
- [2] OECD. **Sustainable development, green growth and quality employment Realizing the potential for mutually reinforcing policies. In: Background Paper for the Meeting of G20 Labour and Employment Ministers Guadalajara.** Organisation for Economic Co-Operation and Development, Paris. 2012.
- [3] Adedeji OH, Adebayo HO, Sotayo EI. Assessing environmental impact of inland sand mining in parts of Ogun state, Nigeria, Ethiopian. **Jour. Of Envi. Stud. & Manag.** 2014; **7**: 478-487.
- [4] Peckenhams JM, Thornton T, Whalen B. Sand and gravel mining: effect on ground water resources in Hancock country, Maine, USA. **Envi. Geo.** 2008; **56**: 1103-1114.
- [5] Fugiel A, Burchart-Korol D, Czaplicka-Kolarz K, Smolinski A. Environmental impact and damage categories caused by air pollution emissions from mining and quarrying sectors of European countries. **J. of Cl. Prod.** 2016; **143**: 159-168.
- [6] Bluvshstein N, Mahrer, Y, Sandler A, Rytwo G. Evaluating the impact of a limestone quarry on suspended and accumulated dust. **Atm. Envi.** 2010; **45**: 1732-1739.
- [7] Howard B and Cameron I. Dust control: Best Practice Environmental Management in Mining. **Envi. Aus.** 1998: 73.
- [8] Etherington JR. Eutrophication of limestone health soil by limestone quarry dust and implications for conservation. **Biol. Conserv.** 1978; **13**: 309-319.
- [9] Schueler V, Kuenmerle T, Schröder H, Impacts of surface gold mining on land use systems in Western Ghana. **Ambio.** 2011; **4**: 528–539.
- [10] Cassidy SM. **Mining Encyclopedia of Science and Technology.** 1997.
- [11] Damigos D. An overview of environmental valuation methods for mining industry. **J. of Cl. Prod.** 2004; **14**: 234-247.
- [12] Acero AP, Rodríguez C, Ciroth A. **Impact assessment method in Life Cycle Assessment and their impact categories.** Greendelta. 2014.
- [13] International Organisation for Standardisation. ISO 14040, **Environmental management-Life Cycle Assessment- principles and framework.** Geneva, Switzerland. 2006.
- [14] Guine'e JB, Gorre'e M, Heijungs R, Huppes G, Kleijn R, De Koning A, Van Oers L, Sleeswijk AW, Suh S, De Haes HAU, De Bruijn H, Van Duin R, Huijbregts MAJ, Lindeijer E, Roorda AAH, Van der Ven BL, Weidema PP. **Handbook on Life Cycle Assessment, operational guide to the ISO standards.** Kluwer Academic Publishers, Dordrecht, the Netherlands. 2002.

# **Session of Hospitality and Tourism Management**

# Comparing Performance of Centralized and Non-Centralized Safety Stock Case Study: Retail Clothing Business

Supreechaya Bunmak<sup>1,\*</sup>, Nathawan Samakachan<sup>1</sup> and Arisara Thaneerananon<sup>2</sup>

<sup>1</sup> Logistics and Supply Chain Management Program, Faculty of Management Science,  
Nakhon Pathom Rajabhat University, Nakhon Pathom 73000, Thailand

<sup>2</sup> Business Education Program, Faculty of Management Science,  
Nakhon Pathom Rajabhat University, Nakhon Pathom 73000, Thailand

## Abstract

This research aims to develop a model of safety stock for retail clothing business between centralized and non-centralized system. Currently, in a case company that used non-centralized system to control their inventory. The company's central warehouse, when supplier delivered finished goods to the warehouse, warehouse staff will check the products and proceed the inventory information to the company database system. After that, all inventory will be sorting out and distributing to retail stores without stocking inventory in the warehouse. There are some company problems with the inventory such as imbalance among retail stores and transferring inventory between retail stores, which have been taken long time. Moreover, waiting period for ordering new products on next period if the retail store can't transfer the inventory to another store. Which may lead to opportunity lost. In this paper, the researcher emphasizes on the efficiency improvement for safety stock system by modifying the safety stock system to a centralized, the majority of inventory stored at company central's warehouse and small lot stored at the retail stores. As a result, the centralized safety stock system can reduce the quantity of safety stock to 1,344 pieces from 2,224 pieces or reduced 39.57% that compared with non-centralized safety stock system and can reduce production costs down to THB 102,960. In addition, the reshuffle of safety stock system has reduced lead time to 1 week from at least 2 weeks for replenishing the inventory to retail stores. This helps to increase the company's commercial opportunities.

**Keywords:** Safety Stock, Centralized, Non-centralized, Retail business

## 1. Introduction

From the current business situation, there is high level of competition and has new entrants to the business in a growing proportion. Each entrepreneur will develop and implement the new strategies that aims to increase market share than other operators in the same business. For the retail clothing business, based on the economic situation analysis [1] prepared by department of business development, Ministry of commerce on December 2015, the retail clothing business that higher the growth rate to register for start-up company. This is opposed to other type of businesses that trend to decrease.

Due to circumstance, there are many business competitors in retail clothing business. The entrepreneurs need to adapt the business plan following current world economic situation. One of the key factors that entrepreneurs must prioritize is the effective planning, implementation and management of their resources. For the trading business, the important resources to the performance of an organization are the production and stock keeping. The optimal of production and storage of materials are important to the profitability of the business.

For the retail clothing business, the inventory management is an important because there are many competitors. If prepared the inventory less than demand, the trade opportunities will be lost. In the other hand if prepare the inventory level to high, the entrepreneur must spend a lot of money to investment and risk of loss from sales.

In this paper, the researcher emphasizes on the efficiency improvement for safety stock system in case study of retail clothing business by modifying the safety stock system to a centralized, the majority of inventory is stored at company central's warehouse and small lot stored at the retail stores instead of non-centralized, all the inventory stored at each retail stores without stocking the inventory at the company's central warehouse. For the research objective as,

1. To study and develop the safety stock model for retail clothing business.
2. Testing results from the model development to compare performance between the current model (Non-centralized safety stock) and the new model (Centralized safety stock)

The researcher has reviewed about the theories and reviewed of the literature as following;

---

\* Corresponding author; e-mail: supreechaya.work@gmail.com

The inventory control system [2], the criteria used to select the inventory control system to suitable the organization's operating strategy. The inventory control system is classified as two types;

Type 1 Continuous inventory system is a system to track the movement of the inventory at all times. This is a system that records the input-output inventory data and represents the current balance of the inventory level on the monitor screen. For a continuous inventory system that is suitable for the high value product and important to the organization to be handled regularly.

Type 2 Periodic inventory system is a system of inventory in which updates are made on period basis, with a set period of the inventory balance check such as weekly, monthly, Quarterly or annual. This system is suitable for the common product and consistent usage product.

For the safety stock inventory system, the product that the organization has calculated for backup stock in cases the product has a higher volume to use than expected, or other unexpected situation. The key factors in determining the quantity of the safety stock inventory that consist of the accuracy forecast, the service level target of the organization, the frequency of replenishment, lead time and other variability.

Service level [4] is an important factor for determining amount of inventories that an organization will reserve to prevent lose any opportunity to sell. However, if the organization has set a high service level, the cost will be high following target level. Therefore, the organizations must be carefully about data analyze and plan strategies.

The concept of risk pooling [5] is an important concept for the supply chain management process. The concept of risk pooling as demand fluctuation will be lower level if aggregate demand from different sources are combined. By reducing such fluctuate, the amount of safety stock inventory of the organization will be reduce. This will be beneficial to the organization in terms of reducing inventory cost. Risk pooling can be accomplished in several methods including consolidating of inventory storage locations to the center warehouse, product integration, consolidation of distribution points.

The research of Sri Krishna Kumar and M.K Tiwari [6] has designed the supply chain system by using the risk pooling technique. In case study is a comparison between the performances of the retailer that independent of each other and retailer work with distribution center. This research method using mix integer nonlinear programming as an implementation tool. The result of the research concluded that the retailer work with distribution center can reduce the total operating cost up to 8.25%

The research of Peter L. Jackson, John A and Muckstadt [7] has studied the impact of inventory system between several retailers and warehouse. The researcher has set the retailer's order cycle twice time by using the risk pooling model. The results of the research showed that the impact on the second order of the product. The effect that the researchers has developed to determine the optimal of the demand for each product in the store. In additional, this research also aims to develop a computer system for the operation of controlling distribution system to retailers.

The research of Z. Kevin Weng [8] has studied the impact of risk pooling which is caused by demand uncertainty. This research study the layout of warehouse and n retail stores. The inventories at the warehouse are include many products of retailers and studied the impact of operation costs, opportunity cost, cost of inventory and ordering cost. The results of the research showed that many retailers use the safety stock inventory to reduce the cost of their products.

## 2. Materials and methods

For company information, in case study is fashion clothing company under their own brand. The company has fashion designers to design product including men's clothing, women's clothing and accessories. There are 10 branches in Bangkok. Target customers of this brand are during adolescence and working age. The highlight of company case study that there are a variety of clothing styles and accessories for the customers to view and select products, so it is attracting a large number of customers to shopping at stores.

In the first step, researcher study of the company's business model. The product that the researcher interested is a T-shirt for men in black and white colour. For the T-shirt for men is available product throughout the year and generates revenue for the company. In product details; each color is available in 5 size as XS, S, M, L, XL. For the production order period of the T-shirt. The company has set an order cycle every four months; the company takes about 1 month to analyze the sales data before ordering and the factory will take 3 months to order production.

**Table 1** The period of T-shirt production and delivery

Month in which the company ordered to factory production	January	May	September
Month at the factory delivery finish goods to company center warehouse	March	July	November

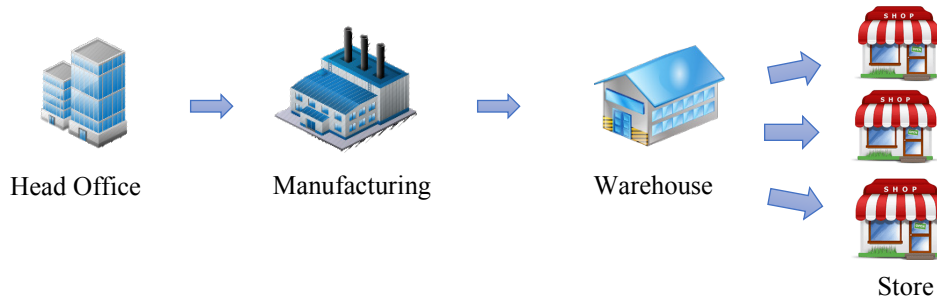
After the factory delivers the finish goods to company central warehouse and warehouse staff will be check the order, counting products and data entry into the warehouse inventory system. Then all the stock are sorting by the number assigned by sales department in each branch and shipping all the product to the store without stock keeping at the warehouse. In case of any branch store requires additional product, they will need to contact other branches to transfer stock and the warehouse will be the operator to transfer the stock between the stores.

For each production order cycle, the sales department will record the sales report in each period of each branch stores and analyze the data and decide the order quantity to production.

For the data analysis consist of 2 parts as

Part 1 Analysis of sales quantity for next period sales forecast data.

Part 2 Analysis for the safety stock volume in each color, size to storage in each branch store.



**Figure 1** Process flow of ordering and shipping information

Based on the operating model of the case study company can be encountered the problem as follow;

For the product distribution method of the company’s case study to all branch stores without some stock backups stored at the company central warehouse. If any branch stores need to transfer the stocks between Branch stores will take a minimum of two week to complete process. Due to the company central warehouse will begin to transfer from one branch and back to warehouse to carry out the paperwork before shipping to other branches. In the other hand, if any branch store do not transfer the products to another store. The branch store will have to wait for the order in the next cycle order, which will take a long time.

From this issues, the researcher is interested to improve the safety stock model in a new format by adjusting the safety stock system from the currently method as non-centralized safety stock to the new method as centralized safety stock system by using risk pooling concept, is to store safety stock inventory at the company central warehouse.

The research process as follow;

Step 1 Determining the amount of safety stock level to reserve in various places with lead time. Lead time is the deciding factor. For the new safety stock model will be stored in two locations as

- One part of safety stock inventory will be stored at company central warehouse, by the time taken for calculating the safety stock inventory a total 4 months or 16 weeks as current operation.

- One part of safety stock inventory will be stored at branch stores. The researcher has added the condition about replenish stock at branch store, each branch stores can request to fill the stock from the company central warehouse on time per week. After company central warehouse received the request they will deliver the products to the branch store at the same day in the week later. So, lest time to calculate for the safety stock level of and branch store is one week.

For the both stock locations use the method of safety stock calculating from the formula.

$$(\sqrt{L} \times \sigma) \times z \tag{1}$$

The explanation of the variable in equations;

L = Lead time for products delivery from source location to destination

Z = Customer service level, the organization is set at 97%

$\sigma$  = Standard deviation of weekly sales report that separate by branch stores, color, size

Standard deviation calculated from the formula as

$$\sigma = \sqrt{\frac{\sum(x-\bar{x})^2}{N}} \tag{2}$$

x = T-shirt’s weekly sales report

$\bar{x}$  = Average sales of all T-shirt

N = Amount of week

Step 2 Calculate the summary of safety stock by using centralized inventory concept; the result obtained from the calculation of safety stock that stored at the company central warehouse and the amount of safety stock that stored at each branch stores.

**Table 2** Total amount of safety stock on the period of sales from December 2015 to March 2016 (Period 1) by using centralized inventory concept

Color	Size	Safety Stock		
		At Warehouse	At Store	Total
Black	XS	19	5	24
	S	65	17	82
	M	72	18	90
	L	24	6	30
	XL	17	5	22
White	XS	21	6	27
	S	99	25	124
	M	67	17	84
	L	31	8	39
	XL	13	4	17
<b>Grand Total</b>		<b>428</b>	<b>111</b>	<b>539</b>

**Table 3** Total amount of safety stock on the period of sales from April to July 2016 (Period 2) by using centralized inventory concept

Color	Size	Safety Stock		
		At Warehouse	At Store	Total
Black	XS	29	8	37
	S	63	16	79
	M	51	13	64
	L	28	7	35
	XL	14	4	18
White	XS	35	9	44
	S	57	15	72
	M	55	14	69
	L	39	10	49
	XL	16	4	20
<b>Grand Total</b>		<b>387</b>	<b>100</b>	<b>487</b>

**Table 4** Total amount of safety stock on the period of sales from August to November 2016 (Period 3) by using centralized inventory concept

Color	Size	Safety Stock		
		At Warehouse	At Store	Total
Black	XS	15	4	19
	S	29	8	37
	M	28	7	35
	L	22	6	28
	XL	12	3	15
White	XS	23	6	29
	S	44	11	55
	M	41	11	52

Color	Size	Safety Stock		
		At Warehouse	At Store	Total
	L	27	7	34
	XL	11	3	14
<b>Grand Total</b>		<b>252</b>	<b>66</b>	<b>318</b>

### 3. Results and discussion

The researcher compared the efficiency of safety stock level between the current pattern as non-centralized and new concept as centralized concept the store main safety stock of T-shirt at company central warehouse, the result are as follow

**Table 5** Total amount of safety stock based on sales report from December 2015 to March 2016 (Period 1)

Color	Pattern	Safety Stock						No. Diff	% Diff
		XS	S	M	L	XL	Total		
Black	As-is of period 1	40	111	113	54	39	357	-109	-30.53
	To be of period 1	24	82	90	30	22	248		
White	As-is of period 1	56	138	112	69	27	402	-111	-27.61
	To be of period 1	27	124	84	39	17	291		

**Table 6** Total amount of safety stock based on sales report from April to July 2016 (Period 2)

Color	Pattern	Safety Stock						No. Diff	% Diff
		XS	S	M	L	XL	Total		
Black	As-is of period 2	57	111	106	85	32	391	-158	-40.41
	To be of period 2	37	79	64	35	18	233		
White	As-is of period 2	61	144	131	87	34	457	-203	-44.42
	To be of period 2	44	72	69	49	20	254		

**Table 7** Total amount of safety stock based on sales report from August to November 2016 (Period 3)

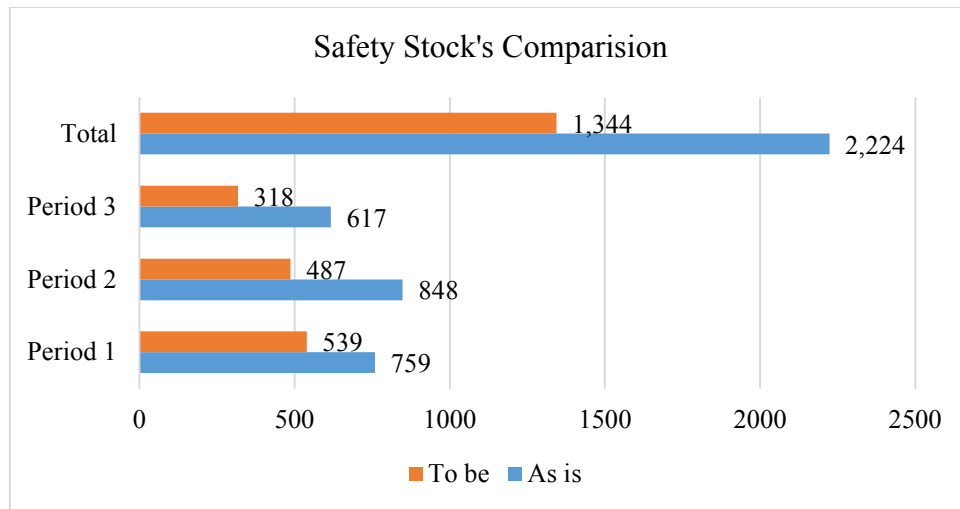
Color	Pattern	Safety Stock						No. Diff	% Diff
		XS	S	M	L	XL	Total		
Black	As-is of period 3	44	79	84	52	26	285	-151	-52.98
	To be of period 3	19	37	35	28	15	134		
White	As-is of period 3	69	86	91	72	14	332	-148	-44.58
	To be of period 3	29	55	52	34	14	184		

Based on the analysis from sales report of three period that can show the safety stock comparison between non-centralized and centralized concept as follow

**Table 8** The result of safety stock based on three period of sales report

Color	Pattern	Safety Stock						No. Diff	% Diff
		XS	S	M	L	XL	Total		
Black & White	As is	327	669	637	419	172	2,224	-880	-39.57
	To be	180	449	394	215	106	1,344		

And can be summarized as a chart



**Figure 2** Result of safety stock’s comparison between non-centralized and centralized concept

By the improvement of safety stock model, the centralized concept can reduce the total of production cost by comparing as follows

**Table 9** The result of production cost

Period	Reduce (/pcs.)	Cost (baht/pcs.)	Cost saving(baht)
Period 1	220	117	25,740
Period 2	361	117	42,237
Period 3	299	117	34,983
Total	880	117	102,960

In additional, from the improvement of safety stock concept to the centralized model. This approach can reduce the waiting time for replenishment of a branch store in case the product is sold out and the branch store requires additional stock, which takes time to synchronize with other stores, and centralized warehouse reduce to one week instead of 2 week for coordinate shipping between branch stores and the company central warehouse

**4. Conclusions**

From this research, Comparing Performance of Centralized and Non-Centralized Safety Stock Case Study: Retail Clothing Business can be summarized that the method of safety stock in a centralized concept has decrease in the total amount of safety stock inventory up to 39.57%. Moreover, the new safety stock pattern will also help the replenishment process in branch store that take time on processing less than current approach at the same time it also increased the company’s business opportunities.

**References**

[1] Department of Business Development. DBD Journal. 36<sup>th</sup> Issue. Bangkok: Ministry of Commerce; 2016.  
 [2] Amornsiri Dissorn. Inventory Management. Bangkok: Odian Store Limited Partnership; 2007.  
 [3] Kumnai Apiprachyasakul. Purchasing Principle. : 4<sup>th</sup> ed. Bangkok: Focusmedia and Publishing Company Limited; 2015.  
 [4] Pipop Lalitaporn. Inventory Management. Bangkok:Technology Promotion Association (Thailang-Japan); 2009.  
 [5] Chaiyot Chaimankong, Mayukapan Chaimankong. Logistics and Supply Chain Strategy Competing in the Global Market. 2<sup>nd</sup> ed. Nonthaburi: Vision Prepress Company Limited; 2007.  
 [6] Sri Krishna Kumar, M.K. Tiwari. Supply chain system design integrated with risk polling. Computer & Industrial Engineering. 2013, 64 (2): 580-588  
 [7] Peter L. Jackson & John A. Muckstadt. Risk Pooling in a two-period, two-echelon inventory stocking and allocation problem. Naval Research Logistics. 1989, 36 (1): 1-26  
 [8] Z. Kevin Weng. Risk Pooling over demand uncertainly in the presence of product modularity. International Journal of Production Economics. 1999, 62 (1-2): 75-8



## **Guidelines for Community Participation in the Woven Fabric Conservation for Cultural Tourism in Phai Hu Change Community in Banglane District, Nakhon Pathom Province**

Pimchanok Mulmit<sup>1,\*</sup>, Jitsupa Rungraung<sup>1</sup>, Bootsarakorn Khunnarong<sup>1</sup>,  
Suttipong Aiemnoo<sup>1</sup>, Supansa Paethong<sup>1</sup>

<sup>1</sup>Tourism and Hotel Department, Faculty of Humanities and Social Sciences,  
Nakhon Pathom Rajabhat University

### **Abstract**

The aims of this research were 1) to study the woven fabric context of Phai Hu Change Community; 2) to study community participate in the conservation of woven fabric; and 3) to discover the guidelines for community participate in woven fabric conservation for cultural tourism. The sample groups consisted of 30 key informants, including local administrative offices, community leaders, woven fabric group members, shop owners, restaurant owners, and local resident in Phai Hu Change Community. In terms of the data analysis, content analysis had been applied and presented in this article.

The results were as follows; 1) the history of woven fabric of Phai Hu Change Community inherited for a long time when the Tai Dam ethnic group emigrated from Petchaburi province and settled at Phai Hu Change in Nakhon Pathom Province. They brought the woven fabric culture, which helped them earn their living. The fabric was commonly black and in watermelon pattern. They used “Ki Kra Took” loom in weaving. The weaving wisdom was uninterruptedly passed down to their descendants in their family; 2) local people in the community participated in decision making and planning of the activities. The community leaders would call for an assembly of the local people when a festival or an event was to be held. And 3) the cultural conservation of Phai Hu Change Community focused on the preservation of the Sen Roeun tradition and Pad Tong ritual, the two majors customs of Tai Dam ethnic people which had represented their history and lifestyle since the olden days .

According to the results, the research was able to found the guidelines for community participation in the woven fabric conservation as follows: 1) The environment conservation should be promoted as it assists to sustain the natural resources which provide the local people with necessary materials and ingredients like the color from True Indigo Tree; 2) more local people should be encouraged to take weaving as their part-time job for alternative career choice in the future; 3) the community should establish a channel to publicize their products, preferably on social media; 4) knowledge pertaining to the culture and its fabric should be shared between local people and tourists to understand the ancient wearing method for value added creation and conservation of weaving fabric and 5) their descendants should be raise awareness of knowledge and importance of conservation of woven fabrics as their heritage that creates value for their locality through cultural tourism activities. 6) The community should create a network of cooperation between their woven fabric group and other local weaving groups in linkage area.

**Keywords:** Guidelines for Community Participation / Cultural Tourism / Woven Fabric/ Tai Dam ethnic people

### **1. Introduction**

Tourism is a growing industry and a major economic factor in Thailand. It attracts a great number of foreign tourists and creates jobs for Thai residents. According to Tourism Statistics 2016, the number of foreign tourists visiting Thailand about 32.6 million in 2016, increased from the previous year’s number by 8.91%. Due to the more stable political climate, drawing in more Chinese tourists, as well as European ones who could adjust themselves to the situation in the country, Thailand’s tourism sees a steady growth [1]. The tourism revenue is worth about 2,510,779 million baht, 1,641,258 of which come from foreign tourists, the rest from native ones. Compared to the last year’s figure, the overall revenue rises by 11.09%. In the international tourism sector, the revenue increases by 12.64%; while in the domestic tourism sector, 8.27%. Thailand’s tourism contributes to the Thai Gross Domestic Product (GDP) of 17.7% [2]. However, tourism is a highly competitive

---

\*Corresponding author; e-mail: neopimm@hotmail.com

industry and can be easily and inevitably affected by negative causes, foreign and domestic alike. The global outlook and situations always pose a challenge to Thai tourism. Their change and impact can greatly affect the development of many forms of Thai tourism, most of which are based on unique cultural identity and the collaboration among the local people in each community [3].

In these times, a local community seems to gain greater and greater popularity as the place of destination among tourists. The participation by the people in a community then becomes essential in sustainable tourism development because they, who have senses of place and ownership, know best how to optimize their own resources. Various forms of tourism also appeal to the tourist's interest, namely, historical tourism, ethnic tourism, and cultural tourism. Regarding this, Tourism Authority of Thailand (TAT) has reviewed the marketing plan accordingly, emphasizing "Thainess," for instance, "Thai smile," Thai cuisine, Thai textile, etc., in order to provide tourists with unique cultural experience. Furthermore, to help enhance the image of Thai tourism, the image of impressive products and services are encouraged to be presented, and tourism should convey the local people's feelings of happiness and pride in being born Thai [4]. In this respect, cultural tourism can be viewed as an instrument which is capable of encapsulating and expressing the local people's way of life, prompting them to preserve their cultural identity. Cultural tourism, thereby, can prolong the life of a culture. [5] Moreover, tourists can encounter local domicile and appreciate indigenous cultures and rituals and local folklores, so the community will be aware of the economic and social value based on their cultural and natural resources via tourism and this will encourage local people to preserve their own heritages [6].

Nakhon Pathom is one of the provinces adjacent to Bangkok, a suitable destination for tourists who have limited amount of time for vacation. The city was one of those most prosperous and culturally rich in times of older civilization in Suvarnabhumi [7]. Bestowed with fertile soil and being a trading hub, it welcomed new settlers from various ethnics, e.g. Mon; Lao Krang, whose weaving technique is remarkable and their textile is used in daily life, as well as in religious rituals; and Tai Dam, also known as Tai Song Dam and Lao Song. The Tai Song Dam people wear black, and their clothes are dyed with the use of indigo. The word "Song," or "Suang," in their ethnic name means pants. Accordingly, the way they are called reflects the way they dress and the clothes they put on them, both of which are now ardently preserved as a part of their identity. Tai Song Dam's weaving technique has been long inherited from their ancestors, originally for domestic purpose. The most outstanding textile is their watermelon-pattern sinh (a kind of a traditional skirt), woven with red weft thread and navy or indigo warp thread. Tai Dam's clothes are made of cotton yarn spun and woven, originally in plain white color. They will later be dyed using tree barks and other parts of some particular plants, say, Burma paduak, indigo, and ebony's fruit. Their weaving technique is also distinct. Normally, the weft thread will be thinner than the warp thread. In Tai Song Dam's weaving, the red weft thread is completely hidden from plain sight. But, when exposed to sunlight, the red weft thread will glow and its color will become visible to the naked eyes. [8]. In this regard, Tai Song Dam's weaving wisdom is indeed an important cultural resource for tourism in Nakhon Pathom.

Phai Hu Chang Community comprises Tai Song Dam people, who migrated from Dien Bien Phu, a city in the northern region of Vietnam, and settled down in Bang Lane District, Nakhon Pathom Province. They brought with them their culture, language, and way of life, all of which contribute to their identity. Their house can provide them a working space for weaving groups. Men, women, and teenagers are capable of weaving. A band of reed mouth organ players is formed to teach the children the instrument, one way to preserve their culture and make their children spend time beneficially. Basketry and other crafting are also taught. There is a Tai Song Dam language class in school. They grow fruit and vegetable without the use of chemicals. Nonetheless, it is found that the community still lacks community participation, which is a fundamental part in cultural tourism development [9]. A variety of fabric patterns are developed, reflecting the people's origin and way of life, for example, the star pattern, the fish scale pattern, the slating pattern, the water pattern, and the mountain pattern. Above all, the watermelon pattern is the most outstanding one. It is produced with the "Mudmee" technique: the selection to dye some part of the fabric, while leaving the other parts covered and unaffected. This technique employs mainly the colors black and navy in the process. The lack of people participation is also mentioned in the study by Nirachara Thongthammachat [10], stating that the local people are not interested in such a matter because they do not believe that cultural tourism can bring more income to the community. Cultural tourism, in fact, has already existed within the community and is officially organized by the community committee. However, in reality, there is only a very small group of people working towards it. Moreover, insufficient PR and advertisement cause the community to remain much unknown to the majority of tourists.

Therefore, this research aims to study the people participation in the conservation of woven fabric for cultural tourism in Phai Hu Chang Community, Bang Lane District, Nakhon Pathom Province, in order to promote cultural tourism and raise awareness of the community's significant role therein. The researchers also

hope to foster the cultural conservation idea in the people, the result of which will help Phai Hu Chang community develop into a place of sustainable cultural tourism.

## 2. Objectives

2.1 To study the context of the woven fabric in Phai Hu Chang Community, Bang Lane District, Nakhon Pathom Province.

2.2 To study the local participation in the conservation of woven fabric for cultural tourism in Phai Hu Chang Community, Bang Lane District, Nakhon Pathom Province.

2.3 To find guidelines of people participation in the woven fabric conservation for cultural tourism in Phai Hu Chang Community, Bang Lane District, Nakhon Pathom Province.

## 3. Methods

3.1 Population referred to 4,226 local residents of Phai Hu Chang Community, Bang Lane District, Nakhon Pathom Province

3.2 Sample groups of 30 people were comprised of 1) the official group, including the Phai Hu Chang Community Leader, the Tambon Administration Authority, and Tambon Administration Officers: through the method of purposive sampling, 2 people were selected; 2) the business owner group: through the method of accidental sampling, 2 grocery store owners and 2 food bistro owners were selected; 3) the local resident group: through the method of purposive sampling, 23 people were selected, including 2 village headmen, 1 sub district headman, 10 people of clothes weaving profession, and 10 local residents

3.3 Research instruments were comprised of an in-depth interview and observation techniques, the latter would be used to verify the information received from the interview and other secondary sources.

3.4 An analysis based on the gathered information would be conducted in accordance with the research objectives.

## 4. Results and discussion

### 4.1 Results

#### 4.1.1 The Context of Phai Hu Chang Community

It is found that the weaving of fabrics in Phai Hu Chang Community has been present since the olden days. The Tai Song Dam people, who migrated into the area, brought with them their culture, including weaving wisdom, the use of a unique kind of loom (Ki Kratook), and watermelon-pattern textiles. Their fabric is usually black. Tai Dam women are expected to be able to weave, regarded as a way to pass down their cultural heritage and preserve their identity, while men will opt for manual craftwork. The made fabric will also be used in the community's festivals and rituals. The weaving wisdom is inherited from one generation to another, the process during which begets new creative ideas. New patterns then emerge, which are more contemporary. The old loom design did not have a shuttle, while the new design has one to help to weave more quickly. The manual weaving process is still preserved: set upon the loom, two sets of threads are made interlaced at right angles, one is called the weft thread, the other, the warp thread. The popular patterns are watermelon, four leaf water clover, episcia flower, Khor Goot, and Sinh Tah Me; and the most common colour is black. These patterns can be made on blanket, handkerchief, pillow, bedspread, etc. The community can add more value to its textile product by informing tourists of the textile's cultural significance. Tourists can also learn the basic of Tai Dam weaving. Realizing that their wisdom can bring fortune to the community, the weaving technique will be passed down to the local's children, consequently contributing to the woven fabric conservation.

#### 4.1.2 Community Participation

It is found that the local people have participation as the principle of participation in 4 levels as follows;

1) As part of getting information; the local people are usually well informed of news and events within the community.

2) As part of discussion; they express their opinion about those matters.

3) As part of decision-making; When organizing an annual event, the local will come together to talk about the details, make a plan and they execute decision for this event. The local are willing to give support in many ways; they will cooperate in preparing the place, cleaning the area, and bringing food, for example.

4) As part of implement; the local are willing to give support in many ways; they will cooperate in preparing the place, cleaning the area, and bringing food, for example.

Moreover, Community participate in Cultural tourism which it is found that the local people are aware of their own unique culture and are eager to preserve it. Some of the residents instruct their children of Tai Dam's way of life. Furthermore, many traditions and customs are still held, such as the Sen Ruan tradition and the Pard

Tong ritual, both of which are of great cultural significance and have been long inherited. Most of the tourists visiting the community are students who are interested in hand-woven fabrics. This group of visitors already has culture conservation mind and is cautious not to cause any damage to the community.

#### 4.1.3 The guidelines for community participation in the woven fabric conservation

The research was able to find these guidelines as follows: 1) The environment conservation should be promoted as it assists to sustain the natural resources which provide the local people with necessary materials and ingredients like the colour from True Indigo Tree; 2) more local people should be encouraged to take weaving as their part-time job for alternative career choice in the future; 3) the community should establish a channel to publicize their products, preferably on social media; 4) knowledge pertaining to the culture and its fabric should be shared between local people and tourists to understand the ancient wearing method for value added creation and conservation of weaving fabric and 5) their descendants should be raise awareness of knowledge and importance of conservation of woven fabrics as their heritage that creates value for their locality through cultural tourism activities. 6) The community should create a network of cooperation between their woven fabric group and other local weaving groups in linkage area.

#### 4.2 Discussion

The woven fabric of Phai Hu Chang Community has long been inherited, a weaving culture of Tai Dam people which is still alive. The fabric is made into garments for usage in daily life, which later becomes their identity. Burutpat Somsong [11] also supported the idea, saying that Tai Dam's fabric are manually woven and used in daily life. The loom used is in antique design. The process of weaving requires high skills and proficiency, as well as excellent memory. No written record thereof exists. The endeavor to either learn or pass down the wisdom, thereby, must be oratory and through memorizing. The weaving techniques, including dyeing and pattern making, are also strictly preserved. The pattern of their fabric is undeniably unique, especially the watermelon one, which is very well-known among the local as Suphan Somthai [12] regarded the fabric pattern as a symbol to convey their belief and traditions. The vertical lines of the watermelon pattern consist of two colors: indigo and white. The white lines appear alone and in pair alternatively. She believes that the pair lines on the pattern, called "Ta Kib" or "Ta Kad," represent other related ethnics, Lao, Thai, and Vietnames, for example, who can live together; whereas the single line, called "Ta Deaw," represents Tai Dam people, who have to leave their homeland. There are other two thick pair lines which do not stand so close to each other, called "Ta Moo," representing the separation of Tai Dam people in Vietnam and Thailand, both of which seem to be unable to come to live together again. Tai Dam people are eager to preserve the weaving wisdom, considering it to be a part of their identity and seeing that it can be used to draw financial benefit towards the community. Moreover, local people in the community participated in decision making and planning of the activities. The community leaders would call for an assembly of the local people when a festival or an event was to be held. As Theron [13] pointed out that there are different shades of opinion on public participation and it related to the process of giving people more opportunities to participate effectively in development activities by empowering them to mobilize their own creative potentials, manage the resources, make decisions and control the activities that affect their lives. Rachaporn Chansawang [14] mentioned this as well, saying that the community participation in tourism management is a fundamental part. To conserve a culture is to highlight its people's identity, which is proved beneficial to the community itself. In accordance with McCool & Martin [15] stated that it is of utmost importance that the people in the community realize their own potential in tourism development, for, then, they can optimize their human resource. The community will become self-reliant and develop a sense of ownership. Tourists will see the value of their culture and pay more attention to it. As a consequence, more tourists will come to visit. The sense of ownership of the community will then grow even stronger, and the people will continue to preserve its own culture and heritage. According to Boonlert Jittangwattana [16], good cultural tourism means plenty of information available, regarding the importance, the origin, and the history of a place. This will provide tourists with valuable travelling experience, and helps the residents learn their own unique value, instilling in them senses of place and ownership. The local will then participate in resource management and benefit from tourism. The guidelines are to offer ways by which the local people can realize the significance and value of their own culture. They also help to supply the information concerning tourists. The way people can benefit from selling merchandise is strongly based on the idea that prioritizes the conservation of their own culture and identity. The idea is in accordance with Payom Thammabut [17] saying that the local residents must participate in making decision regarding any project which has an impact of their way of life and always keep in mind the community's capacity to bear the effect of tourism. Income distribution amongst the local should also be the focus, and the local people should benefit from tourism in the long run. They should also put greater emphasis on environmental and cultural conservation than on tourism and aims to utilize local and natural materials.

## 5. Conclusions

The woven fabric in Phai Hu Chang Community is the product of the wisdom of Tai Dam people who migrated into the area. The fabric is mostly of domestic purpose and in watermelon pattern, with black as its most common color. It is also used in many local traditions and customs. The “Ki Kratook” loom is utilized in the making. This wisdom is passed down from generation to generation. Regarding the process, most of the fabrics are manually woven with the aid of loom. Two sets of threads are made interlaced at right angles: one is called the deft thread; the other, the warp thread. Most woven patterns are watermelon, four leaf water clover, episcia flower, Khor Goot, and Sinh Tah Me, all of which can be made upon blanket, handkerchief, pillow, and bedspread. The local people can sell the fabric as their community’s unique product and increase its value by informing tourists of the weaving process and its cultural significance. Accordingly, tourists can learn how to weave with the local. Regarding community participation in the woven fabric conservation in Phai Hu Chang Community, it is found that the local people are commonly involved, whether in organizing or taking action. A great number of people are willing to help with manual work during the community’s festival or other events. The culture of Phai Hu Chang Community has been long inherited, and the people are aware of that. Therefore, there is an attempt in culture conservation, including their weaving wisdom, the Sen Ruan tradition, and the Pard Tong ritual, all of which helps to accentuate Tai Dam’s identity. The tourists who come to visit the community are mostly students. They are interested in the weaving wisdom and so pose no threat to the culture.

From the study, the researchers are able to form the guidelines for community participation in the woven fabric conservation for cultural tourism in Phai Hu Chang Community, Bang Lane District, Nakhon Pathom, which are as follows: 1) environment conservation should be promoted, as it helps to sustain the natural resource which provides the local with necessary materials and ingredients; 2) more local people should be encouraged to take weaving as their occupation; 3) the community needs to establish a channel to publicize their products, preferably on social media; and 4) knowledge pertaining to the culture and its fabric should be shared with tourists as to help them realize the product’s cultural significance and to increase the product’s value; 5) their descendants should be raise awareness of knowledge and importance of conservation of woven fabrics as their heritage that creates value for their locality through cultural tourism activities and 6) The community should create a network of cooperation between their woven fabric group and other local weaving groups in linkage area.

Finally, culture tourism is the form of tourism that attracts tourists get satisfaction and adds value of experience so tourists revisit under many local activities according to cultural tourists’ expectation. Moreover, culture tourism can emphasize local people take part in their tourist activities and gain the equal benefits that mean it will generate income for local community

## References

- [1] Ministry of Tourism and Sports. **Tourism statistic [Internet]**. 2017. [cited 11 June 2017]. Available from: <http://tourism2.tourism.go.th/home/details/11/221/25801>
- [2] Bangkokbiznews. **Tourism sector in the fiscal year 2016, increasing 17% of GDP [Internet]**. 2016. [cited 11 June 2017]. Available from: <http://www.bangkokbiznews.com/news/detail/740824>
- [3] Tourism Council of Thailand. **Thailand tourism confidence index [Internet]**. 2016. [cited 11 June 2017] Available from: [http://www.thailandtourismcouncil.org/imgadmins/confidence\\_file/TCT\\_confidence\\_file\\_th\\_2016-12-28\\_13-53-38.pdf](http://www.thailandtourismcouncil.org/imgadmins/confidence_file/TCT_confidence_file_th_2016-12-28_13-53-38.pdf)
- [4] Tourism Authority of Thailand. **TAT review 2016: Thai tourism campaign 2016 [Internet]**. 2016. [cited 14 June 2017]. Available from: <http://www.etatjournal.com/web/menu-read-tat/menu-2015/menu-42015/686-42015-destination>
- [5] Krairerk P. Creative economy capital, culture and business opportunities. **Journal of Management** . 2013; 31: 32-37.
- [6] Responsible tourism. **What is community based tourism? [Internet]**. 2016. [cited 15 October 2017]. Available from: <https://www.responsibletravel.com/copy/what-is-community-based-tourism>
- [7] Nakhon Pathom Governor’s Office. **Nakhon Pathom Province 2016 [Internet]**. 2016. [cited 21 July 2017]. Available from: [http://www.nakhonpathom.go.th/files/com\\_news\\_describe/2016-06\\_abd0f2a5f6240e7.pdf](http://www.nakhonpathom.go.th/files/com_news_describe/2016-06_abd0f2a5f6240e7.pdf)
- [8] Institute of Mekong-Salween Civilization Studies. **The Exhibition of Thai Dam ethic with uniqueness, black attire and the ritual of spirituality [Internet]**. 2014. [cited 23 October 2016]. Available from: <http://www.msos.nu.ac.th/msosv2/?name=knowledge&file=readknowledge&id=207>
- [9] Nopparat Y et al. **Guidelines for Cultural Tourism Promotion for in Phai Hu Change Community in Banglane District, Nakhon Pathom Province**. Nakhon Pathom: Nakhon Pathom Rajabhat University; 2013.

- [10] Nirachara T. **Sustainable Tourism Development in Phai Hu Change Community**. Bangkok: Suan Sunandha University; 2013.
- [11] Burutpat S. **Encyclopedia of Thai Dam ethnic groups.1st ed. Nakhon Pathom**. Research Institute for Languages and Cultures of Asia. Mahidol University; 1997
- [12] Suphan S. **Design of home decorative products by the concept of Thai Dam ethnic culture Bangkok**. National Research Council of Thailand; 2006.
- [13] Theron F. Public participation as a micro-level development strategy, in Davids, F. Theron and K. J. Maphunye. Participatory development in South Africa. A development management perspective. Pretoria: Van Schaik Publishers; 2005.
- [14] Rachaporn C. **Introduction to Tourism Long Distance Training Package Sustainable community**. Bangkok: Ministry of Tourism and Sports; 2003.
- [15] McCool SF, Martin SR. Community attachment and attitudes toward tourism development. **Journal of Travel Research**. 1994; 32: 29-34.
- [16] Boonlert J. **Tourism Industry**. 1st ed. Bangkok: Thammasat University; 2005.
- [17] Payom T. **Text book of Seminar 2**. Bangkok: University of Phayao; 2014

# **The Guidelines for Public Relations and Tourism Promotion of the Wat Tha Phut Folk Museum, Rai Khing Subdistrict, Sam Phran District, Nakhon Pathom Province**

Prapon Leksuma<sup>1</sup> and Nilubon KongPrem<sup>2</sup>

Tourism and Hotel Program, Faculty of Humanities and Social Sciences,  
Nakhon Pathom Rajabhat University

## **Abstract**

This research aimed to form the guidelines for public relations and tourism promotion of the Wat Tha Phut Folk Museum. The data collection method used was in-depth interview with 25 interviewees. It was found that the Wat Tha Phut Folk Museum housed a collection of antiques and was a place of tourist attraction where visitors could learn about the local's way of life, culture, customs, and history. The guidelines for public relations and tourism promotions consisted of the employment of 3 channels: 1) person-to-person public relations, in which visitors' words would promote tourism directly; 2) print media, which included the tourist manual, brochures, and posters, all of which were aided by interesting content and infographics; and 3) online media, through which tourism events and activities would be promoted via, for example, Line, YouTube, and Facebook. This guidelines aimed to appeal to the tourists who were interested in local way of life and history.

**Keyword:** Public Relation, Museum and Tourism

## **1. Introduction**

Tourism industry is one important factor in Thai economy. In 2015, Thailand's tourism revenue reached 2.23 billion baht, 1.44 of which were from foreign tourists, while the other 0.79 from native ones [1]. Tourism industry also instigates investment, employment, and income distribution to the rural area, as well as contributes development to many regions of the country [2].

Thailand is globally known for its beautiful culture, customs, history, ethnic diversity, and people's hospitality, all of which draw visitors to the country. Ministry of Tourism and Sports encouraged alternative forms of tourism where tourists could learn more and engage in local activities, to illustrate, ecotourism, creative tourism, and cultural tourism [3].

A museum is considered an important cultural tourist attraction, the keeper of history, art, and culture. The purpose of visiting a museum is to peak one's interest about the exhibited object and gain more knowledge in a relaxing, enjoyable way. Visitors will be interested to learn more about different matters depending on what type of museum they visit, for example, historical and archaeological museum, contemporary art museum, machinery museum, natural history museum, anthropological museum, ethnic museum, and folk museum [4].

Nakhon Pathom province is the city of historical importance, believed to have been founded since the Dvaravati period. It contains a great amount of historical and archaeological evidence, and, thereby, has many places to house them, for example, Sanam Chandra Palace, Phra Pathom Chedi National Museum, Wat Samrong Folk Museum, and Wat Tha Phut Folk Museum [5].

The Wat Tha Phut Folk Museum is another learning center in Nakhon Pathom Province where antiques are kept. It is not famous among tourists, though, due to the lack of public relations and usage of media. The museum then could not efficiently develop. This research, thereby, aims to form the guidelines for public relations and tourism promotion of the Wat Tha Phut Folk Museum, Nakhon Pathom, with the hope that the place will become better known among people, local and foreign alike, and can attain sustainable tourism in the future.

## **2. Literature Review**

Tourism promotion means stimulating sales through the dissemination of information. It means trying to encourage actual and potential customers to travel. According to Salah Wahab, the objectives of promotion are: 1.To make the tourist product widely known. 2.To make it very attractive in order to encourage many people to try it. 3.To make the message attractive without being dishonest

**3. Research Objectives**

3.1 To study the context of the Wat Tha Phut Folk Museum, Rai Khing Subdistrict, Sam Phran District, Nakhon Pathom Province.

3.2 To study the forms of tourism of the Wat Tha Phut Folk Museum, Rai Khing Subdistrict, Sam Phran District, Nakhon Pathom Province.

3.3 To form the guidelines for public relations and tourism promotion of the Wat Tha Phut Folk Museum, Rai Khing Subdistrict, Sam Phran District, Nakhon Pathom Province.

**4. Scope of the Research**

**Area Scope** The area scope in this research was Wat Tha Phut Temple, Rai Khing Subdistrict, Sam Phran District, Nakhon Pathom Province, and its vicinity.

**Content Scope** The content scope involved the concepts and theories of cultural tourism, tourism promotion, museum, public relations, as well as other studies relating to museum tourism.

**Population Scope** The population scope comprised 25 people who are involved with the Wat Tha Phut Museum, including the local residents, tourists, scholars, public and private agencies.

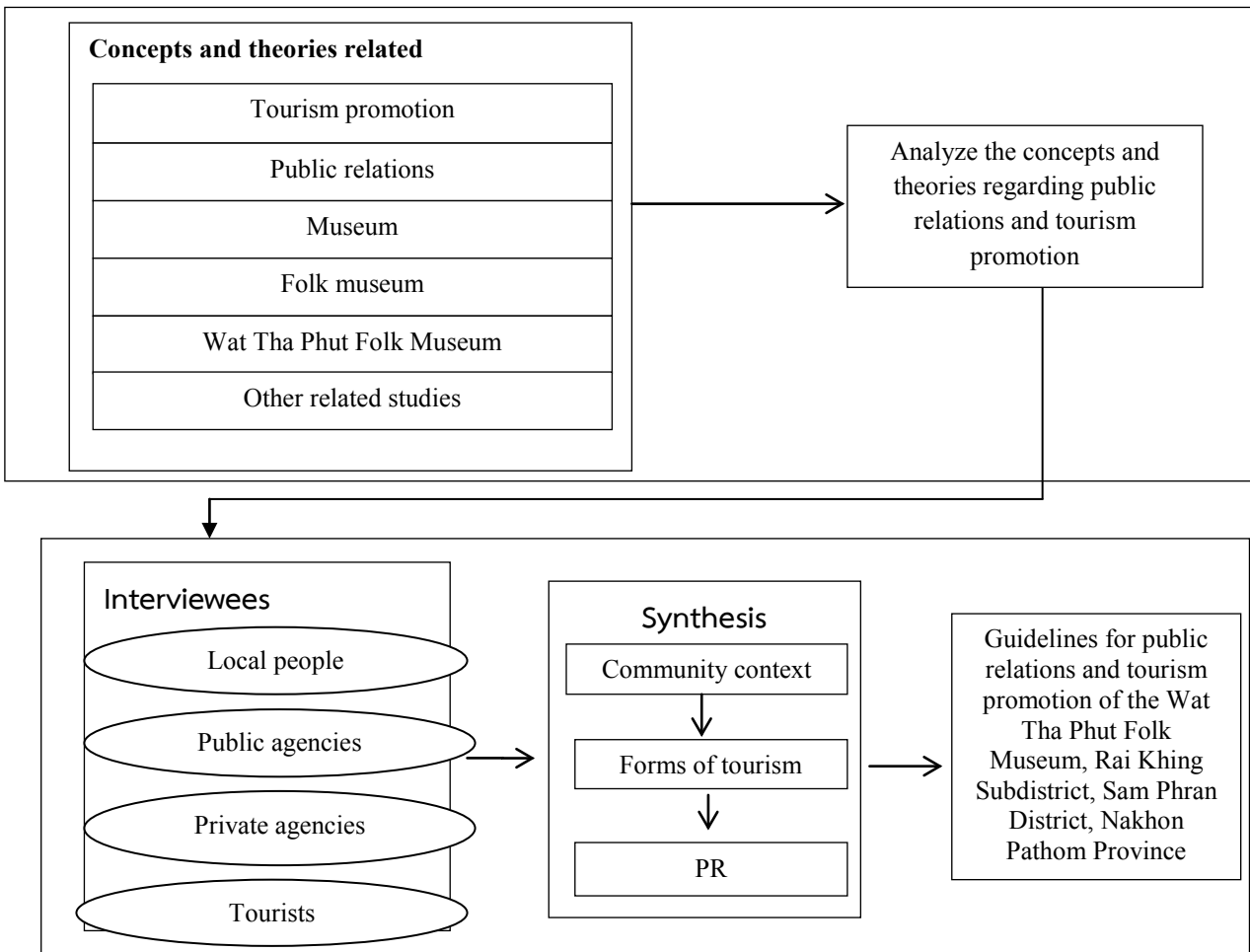
**5. Research Benefits**

5.1 To understand the context of the Wat Tha Phut Folk Museum, Rai Khing Subdistrict, Sam Phran District, Nakhon Pathom Province.

5.2 To understand the forms of tourism of the Wat Tha Phut Folk Museum, Rai Khing Subdistrict, Sam Phran District, Nakhon Pathom Province.

5.3 To be able to form the guidelines for public relations and tourism promotion of the Wat Tha Phut Folk Museum, Rai Khing Subdistrict, Sam Phran District, Nakhon Pathom Province.

**6. Conceptual Framework**



**Figure 1 Conceptual Framework**



## 7. Methods

Two steps were employed in this research:

### 7.1 Documentary Research

The researchers gathered information from books and research papers, written in Thai or English. The collected information included the concepts and theories regarding cultural tourism, tourism promotion, museum, public relations, as well as other relevant studies. The researchers then synthesized the acquired information to create the interview form.

### 7.2 In-depth Interview

The interview form then were applied to 25 interviewees, categorized into 5 groups: the local residents, tourists, scholars, public agencies, and private agencies. The tools employed were the interview forms, a recorder, and a notebook to write down important piece of information. Also, regarding the interview, the interviewees would be notified beforehand. The pieces of information acquired then would be validated with the triangulation method. They would be compared with one another. Should contradiction arise, the interviewees would be contacted and asked to confirm their answer via telephone call or email. The piece of information which was deemed to lack credibility or correctness would be disposed and not used in this research. Then, Analysis data by pattern matching [6] consists 3 step following 1. Data reduction 2.Data display and 3. Conclusion drawing and verification.

## 8. Results and Discussion

It is found that the history which related to the Wat Tha Phut Folk Museum went back into the far past. Around the period after the second fall of Ayutthaya Kingdom, Wat Tha Phut Temple was founded along the river known at present as Tha Chin by a Buddhist Monk Rot, who was the first abbot. The Wat Tha Phut Folk Museum was founded later in the modern era, as people feared that many existing antiques might be lost or stolen. The museum received great support from Princess Maha Chakri Sirindhorn Anthropology Centre in organizing and registering the antiques. The museum comprised 3 buildings. The first one, "Tipitaka Hall in the reign of King Rama III," held ancient objects, for example, a royal palanquin, a tea pot, a Tom Pat spittoon, which King Tank Sin granted to Monk Rot. The second one, "Former Abbot's House," displayed the abbot's utensils, Buddhist monk's requisites, and some of the temple's property, for example, blue and white ware, old banknotes, and valuable shells. The last building, "Dharma Study Building in the reign of King Rama V-VI," was made of teak wood and decorated with wood carvings. It displayed newspaper of olden days and other documents, as well as the utensils which the local had given to the temple. The local people were in charge of organizing the museum themselves. This museum followed the notion proposed by Worrapong Worachadudompong [7] saying that a museum was a place to display and house antiques and intellectual property. It was also a place of relaxation, as well as of research and education, the reference of knowledge in various fields.

The form of tourism of the Wat Tha Phut Museum, therefore, was that whose purpose was to gain more knowledge, whether about the local history or the people's way of life and culture. Most of the visitors came in group. They were teachers and students. Other visitors included those who were particularly interested in history and culture. This group of tourist usually visited the museum during the annual festival of Wat Tha Phut Temple.

Regarding the public relations, it was found that the Wat Tha Phut Folk Museum had 3 channels: person-to-person PR, print media, and online media. The person-to-person PR depended on the local people to give information to tourists and raise their interest in the museum. The print media were in the form of booklets and brochures providing information pertinent to Wat Tha Phut Temple and the museum. The online media consisted of the temple's website and Facebook page.

With the data provided above, the guidelines for public relations and tourism promotion of the Wat Tha Phut Folk Museum could be formed accordingly, as follows:

1) Person-to-person PR: Tourists could be encouraged to speak about the temple and the museum on different websites. Web bloggers and those who owned social media space could help to spread the information, too.

2) Print media: Good design could help to make the tourist manual, brochures, and posters more interesting, preferably with the aid of images and infographics. They should also be available in the famous tourist attraction spots in Nakhon Pathom whose travelling routes could connect to the museum. Worrapong Worachadudompong [7] also supported the use of brochures and posters, saying that they played a significant role in PR and were convenient to handed out widely. Also, with the use of them, the targeted group of tourist could become better focused.

3) Online media: Events and activities could be promoted through this means. PR videos could be made and published on Line, Facebook, YouTube, etc. when a festival or a special occasion were to be held.

These 3 channels focused on visitors who were interested in the local's way of life and the local history. This group of tourist was considered to be of decent quality and their tourism form was regarded with the term "Special Interest Tourism," including, for example, cultural tourism and experiential tourism [8]. This type of tourism put emphasis on experiencing local people's real way of life and culture, rather than mere sightseeing [1].

## 9. Reference

- [1] Ministry of Tourism and Sports. **National tourism development plan 2. 2017 [Internet]**. Available from: [http://www.mots.go.th/ewt\\_dl\\_link.php?nid=8409](http://www.mots.go.th/ewt_dl_link.php?nid=8409)
- [2] Boonreat J. **MICE Business**. Fern Khaluang, Printing and Publishing. 2014
- [3] Salisa T, Prakasit S. Creative tourism. Alternative options-survivor options. **Academic journal**. Pathumthani University 2016; Year 8 No.2 July-December
- [4] Suthasinee W. **Research Report Learning Power of Museum: Case study England. Bangkok: Office of the Basic Education Commission**. 2001
- [5] Nakhon Pathom Provincial office. **Nakhon Pathom Strategic plan 4 year (2015-2018) of Thailand**. Nakhon Pathom Official; 2014
- [6] Yin, Robert K. **Case study research, Design and Method**. 3<sup>rd</sup> ed. Vol. 5. Thousand Oaks: Sage; 2003
- [7] Worrarong W. **Graphic design**. Bangkok: Sophon Printing; 1997.
- [8] Hall CM, Mitchell R. Gastronomic tourism: Comparing food and wine tourism experiences. In M. Novelli (Ed.), **Niche Tourism: Contemporary Issues, Trends and Cases**. Oxford: Elsevier Butterworth Heinemann; 2005; 73-88
- [9] Tourism Authority of Thailand. **National tourism strategic plan 2017-2021**. Office of the Permanent Secretary, the war Veterans Organization; 2017.

# **Session of the Interdisciplinary Research**

# Utilization of pretreated peanut hulls for the optimized bioproduction of cellulase by *Pycnoporus Sanguineous*

Methus Chuwech<sup>1,\*</sup>, Nuansri Rakariyatham<sup>1</sup>, Kawin Supawittayayothin<sup>1</sup>,  
Niphorada Yawirat<sup>1</sup>, Nopakarn Chandet<sup>2</sup>, Jidapha Tinoi<sup>2</sup> and Phakhawat Jaisin<sup>3</sup>

<sup>1</sup>Faculty of Health Science, Nation University, Lampang 52000, Thailand

<sup>2</sup>Department of Chemistry, Faculty of Science, Chiang Mai University, Chiang Mai 50200, Thailand

<sup>3</sup>Faculty of Business Administration, Nation University, Lampang 52000, Thailand

## Abstract

Thailand is an agricultural country, producing tons of agricultural waste (rice straw, corncobs, coconut husk, sugarcane bagasse, cassava peel, and peanut hulls). Instead of eliminating, these biomasses can be converted to a value-added product, cellulase enzyme for industrial sector. Peanut hulls are one of excellent sources for cellulose, which can be used as a carbon source for microbial cellulase production. This study is conducted by experimental design using pretreated peanut hulls as a substrate via solid-state fermentation (SSF) by white-rot fungus, *Pycnoporus sanguineous*. The three treatments: (1) initial moisture in solid substrate (60%, 70%, 80%, and 90%), (2) temperature (25°C, 30°C, and 37°C), and (3) initial pH value (5.0, 5.5, 6.0, 6.5, and 7.0) on cellulase production in 3–12 days of incubation were observed in flask fermentors. The highest productions were obtained on the 9th day of incubation at 70% initial moisture, 30°C, and initial pH 6.0. The enzyme activities of filter paper activity (FPase), carboxymethyl cellulase (CMCase) and cellobiase were 4.437±0.148, 11.433±0.144 and 0.890±0.087 unit per gram dry substrate (U/gds) respectively. These results supported that the cellulase production by *P. sanguineous* under SSF using pretreated peanut hulls as a substrate could be an alternative choice for commercial cellulase production.

**Keywords:** Peanut Hulls, Cellulase, Solid-State Fermentation, *Pycnoporus sanguineous*

## 1. Introduction

Cellulose is the main component of agricultural waste, such as that is obtained from rice straw, corn cobs, coconut husk, sugarcane bagasse, cassava peel and peanut hulls. It contains a *glucose* unit joined together in long chains by  $\beta$ -1,4-glycosidic linkage. The bioconversion of cellulose to value-added products such as glucose requires a cellulase enzyme system comprised of endoglucanases (EC 3.2.1.4) which act randomly on soluble and insoluble cellulose chains, as well as exoglucanases (cellobiohydrolases; EC 3.2.1.91) which liberate cellobiose from the reducing and non-reducing ends of the cellulose chains and  $\beta$ -glucosidases (EC 3.2.1.21) which liberate glucose from cellobiose [1-3]. Cellulases play a significant role in emerging energy and various other biotechnological processes, such as food, textile, paper and pulp, agriculture, and environment [4]. However, production cost of enzymes is very high and accounts for about 40–60% of the total production cost [5]. According to an estimate, cellulases alone contribute 22.5–43.4% to the total cost of cellulosic ethanol production when enzymes are procured from commercial sources [6]. For this reason, the cost of enzyme is considered to be a major hindrance in the widespread commercialization of enzymatic lignocellulosic biomass hydrolysis. In the recent years, research efforts have been focused on lowering the cost of enzyme. Utilization of abundant renewable lignocellulosic biomass, especially agricultural waste residues, agro-industrial waste and their by-products as substrates can help to reduce cellulose prices [7]. Also the use of cheaper technologies like solid-state fermentation can further improve the production economics. SSF technology results in an enzyme preparation, which is more concentrated and hence, best suited for biomass conversion applications [8].

Cellulases are produced by many microorganisms, such as fungi, bacteria and actinomycetes. However, due to high yields, fungi have been commercially exploited for production of these enzymes. Among fungi, *Trichoderma* and *Aspergillus* have been widely exploited for their physical ability to produce cellulases [9]. *Pycnoporus sanguineous* is a white-rot fungus that produces ligninolytic enzymes such as laccases and cellulase [10].

Peanut hulls are abundant agro-industrial waste products that are recalcitrant to degradation under natural conditions [11]. The increasing expansion of peanut production has led to accumulation of large quantities of these shells all over the world. In the US alone, peanut production increased by 45% between 2011 and 2012, bringing production to 3.04 million metric tons [12]. Globally, 45.6 million metric tons of peanuts are produced

\*Corresponding author; e-mail: methus\_chu@nation.ac.th

annually [13]. It has been estimated that for every kg of peanuts produced, 230-300 g of peanut hulls are generated [14]. Therefore, as much as 13.7 million metric tons of peanut hulls are churned out every year, most of which are dumped into the environment or burned [15-16]. Peanut hulls are one of the interesting abundant agricultural by-products that result from passing through the shelling-machine process, a renewable resource that could be targeted for purposeful use in the food, feed, paper and bioenergy industries. Peanut shells contain high amounts of cellulose (40.5%), lignin (26.4%) and hemicellulose (14.7%) [17]. However, as yet, few if any value-added uses exist for them [18].

The SSF has been reported on by several researchers as an attractive process to produce cellulase [19]. However, there has not been any report on the utilization of low cost peanut hulls as a substrate for cellulase production. The aim and objectives of present work was to optimize production of cellulase enzymes from *P. sanguineous*, a white-rot fungus, under solid state fermentation. The level of initial moisture content, temperature and initial pH value for the production of cellulase through the use of peanut hulls as a substrate under SSF have been optimized.

## 2. Materials and methods

### 2.1 Microorganisms

The white-rot fungus, *P. sanguineous* was cultivated on potato dextrose agar (PDA) plates containing 2.0% agar and was then incubated at ambient temperatures for 7 days.

### 2.2 Detection of microbial cellulase on agar plate

A preliminary qualitative analysis of the cellulase activity was conducted using Congo red dye [19]. *P. sanguineous* was grown on CMC agar containing 0.2% NaNO<sub>3</sub>, 0.1% K<sub>2</sub>HPO<sub>4</sub>, 0.05% MgSO<sub>4</sub>, 0.05% KCl, 0.2% carboxymethylcellulose (CMC) sodium salt, 0.02% peptone and 1.7% agar. Plates were incubated at ambient temperatures for 3 days. The agar medium was flooded with 0.1% Congo red dye for 15-20 minutes, and then de-stained with 1M NaCl for 15 minutes. The formation of a clear zone of hydrolysis indicated cellulose degradation.

### 2.3 Raw materials and their pre-treatment

Peanut hulls were obtained from a local market in Chiang Mai Province, Thailand. These raw materials were first dried and chopped into small pieces by a chopper, then grounded into smaller particles in a hammer mill (Armfield, England) and finally separated by a 20-mesh sieve. The pretreatment of peanut hulls was carried out separately with 0.5% (w/v) H<sub>2</sub>SO<sub>4</sub> and 2.5% NaOH at 121 °C for 15 minutes. The pretreated residues were washed extensively to the neutral pH value (7.0) level and dried at 60 °C in an oven.

### 2.4 Cellulase production under solid-state fermentation

Solid-state fermentation was carried out in 250 ml Erlenmeyer flasks, each containing 2.0 g of dry pretreated peanut hulls, initial moisture was adjusted with a mineral salt solution [(NH<sub>4</sub>)<sub>2</sub>SO<sub>4</sub>, 0.5 g l<sup>-1</sup>; KH<sub>2</sub>PO<sub>4</sub>, 0.5 g l<sup>-1</sup>; MgSO<sub>4</sub>, 0.5 g l<sup>-1</sup> and pH 5.5]. The flasks were sterilized by autoclaving at 121 °C (15 psi) for 15 minutes and after that were cooled to room temperature. Inoculation was performed using a sterile cork borer, in 7-day old mycelium of *P. sanguineous* agar disc (diameter, 0.6 cm.) The medium content in the flasks were mixed well and incubated at 25 °C in an incubator for 12 days. The maximum amount of enzyme production was measured in terms of enzyme activity and selected for further study.

#### 2.4.1 Time course of cellulase production and effect of moisture content

To optimize conditions for fermentation, flasks containing 2.0 g of dried pre-treated peanut hulls were used with various levels of moisture content (60, 70, 80 and 90%), and periods of fermentation time (3, 6, 9 and 12 days). Other factors were constant at an initial pH value of 5.5, with a fermentation temperature of 25 °C. Fermented products were harvested in triplicate at the specified fermentation times and analyzed for cellulase activities.

#### 2.4.2 Effect of incubation temperature and initial pH on cellulase production

Cellulase production by the fungus, *P. sanguineous* was optimized following the effects of the environmental parameters such as incubation temperature (25,30 and 37 °C) and initial pH value (5.0, 5.5, 6.0, 6.5 and 7.0) to increase cellulase activity through the use of the optimal fermentation time period and the optimal level of initial moisture content acquired from the preliminary process.

### 2.5 Enzyme extraction

The enzymes were extracted by adding 15 ml of 50 mM citrate buffer (pH 4.8) to the solid state cultures and the medium contents were shaken on a rotary shaker at 150 rpm for 60 minutes at room temperature. The contents in the flasks were then filtered through a metallic sieve and the solid residue was pressed to remove any remaining liquid, followed by centrifugation (10000×g for 15 minutes at 4 °C) and the supernatant was analyzed for its enzyme activities.

### 2.6 Enzyme activity assays

The total cellulase (filter paper cellulase, FPase), carboxymethyl cellulase (CMCase) and cellobiase activities were determined in accordance with the International Union of Pure and Applied Chemistry

procedures and were expressed as international units (IU) [21]. Samples were collected every 3 days during the fermentation process for the determination of cellulase activity. Filter paper cellulase (FPase) was assayed by measuring the release of reducing sugars in a reaction mixture of Whatman's No. 1 filter paper (1.0×6.0 cm.) as a substrate in 50 mM sodium citrate buffer (pH 4.8) at 50 °C, after 60 mins of incubation. Carboxymethyl cellulase (CMCase) activity was assayed by measuring the release of reducing sugars in a reaction mixture containing 0.5 ml of crude enzyme and 0.5 ml of 2% (w/v) of carboxymethyl cellulose solution in 50 mM sodium citrate buffer (pH 4.8) incubated at 50 °C for a period of 30 min. The liberated reducing sugars were measured using 3, 5-dinitrosalicylic acid (DNS), according to the method of Miller [22]. One international unit of FPase and CMCase activity is equivalent to the amount of enzyme that releases 1 μmol of glucose per min during the hydrolysis reaction. Cellobiase activity was determined using 15 mM cellobiose at 50 °C after 30 min of incubation. One international unit of cellobiase activity is the amount of enzyme that forms 2 μmol of glucose per min from cellobiose. The values of enzymatic activity were expressed as IU/gds (international units per gram dry substrate).

### 2.7 Data analysis

Enzyme activity values were expressed as means±S.D. of three replications calculated using MS Excel 2007

## 3. Results and discussion

### 3.1 Detection of microbial cellulase on agar plate

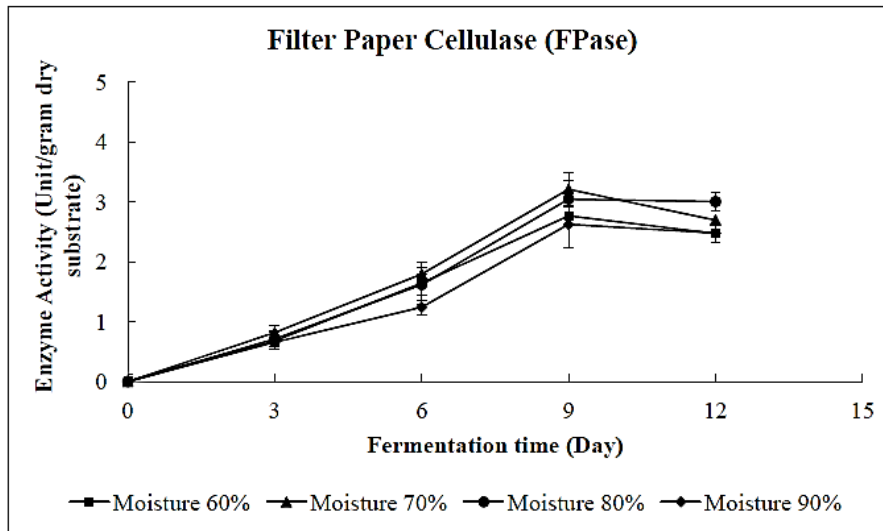
The fungal strain *P. sanguineous* was grown on CMC agar plates and checked for cellulase activity by incubation at ambient temperatures for 3 days. The cellulase activity was indicated as a clear orange halo after the strain was stained with 1% congo red solution. *P. sanguineous* showed a clear zone with a diameter of 28 mm. This result indicated that *P. sanguineous* had the definitive potential to produce cellulolytic enzymes.



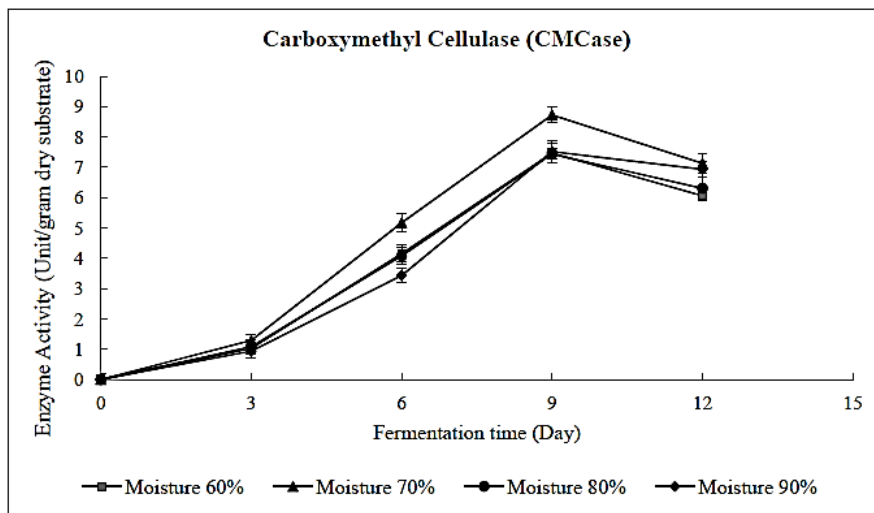
**Figure 1** *P. sanguineous* showed a clear zone of hydrolysis, which indicates CMC degradation.

### 3.2 Time course of cellulase production and effect of moisture content

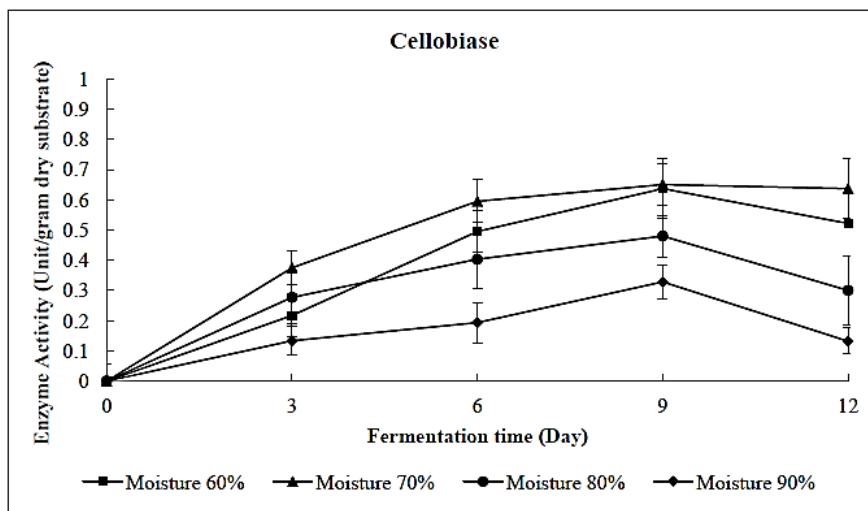
In the present study, the maximum production of FPase, CMCase and cellobiase occurred after 9 days of *P. sanguineous* with an initial moisture content of 70% (Figure 2-4) with the yields of  $3.214 \pm 0.105$  U/gds,  $8.725 \pm 0.121$  U/gds and  $0.651 \pm 0.053$  U/gds, respectively. However, the activity of these enzymes declined gradually after 9 days of fermentation.



**Figure 2** Fermentation time profiles of filter paper cellulase (FPase) activity of peanut hulls



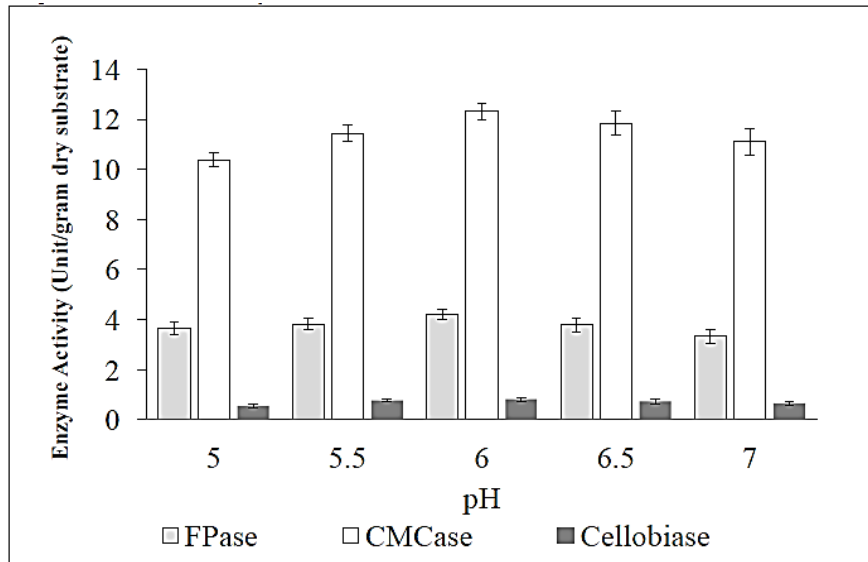
**Figure 3** Fermentation time profiles of carboxymethyl cellulase (CMCase) activity of peanut hulls



**Figure 4** Fermentation time profiles of cellobiase activity of peanut hulls

### 3.3 The effect of initial pH value on cellulase production

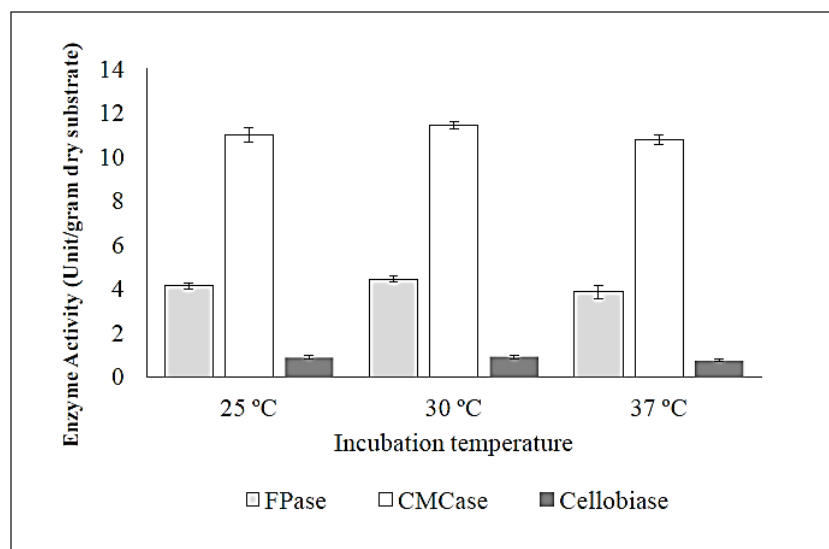
To study the effect of initial pH value on cellulase production, the pH value was adjusted between 5.0-7.0. The production profiles of all three enzyme components are shown in Figure 5. The highest FPase ( $4.197 \pm 0.191$  U/gds), CMCase ( $12.303 \pm 0.322$  U/gds) and cellobiase ( $0.824 \pm 0.077$  U/gds) activities were observed at a pH value of 6.0 on the 9<sup>th</sup> day of incubation at 70% initial moisture.



**Figure 5** Cellulase activities at different pH levels on the 9<sup>th</sup> day of incubation at 70% initial moisture

### 3.4 The effect of incubation temperature on cellulase production

The temperature of the fermentation medium is one of the parameters that have a significant influence on the end-product. Figure 6 illustrates the enzyme activity as it increased with an initial increase in temperature to 30 °C. When cultivated at 37 °C, the activity of the enzymes decreased substantially. The highest yields of FPase ( $4.437 \pm 0.148$  U/gds), CMCase ( $11.433 \pm 0.144$  U/gds) and cellobiase ( $0.890 \pm 0.087$  U/gds) were obtained at 30 °C on 9<sup>th</sup> day of incubation, at a pH value of 6.0 and 70% initial moisture, whereas these cellulase activities were reduced to FPase ( $3.848 \pm 0.315$ ), CMCase ( $10.788 \pm 0.209$ ) and cellobiase ( $0.725 \pm 0.049$ ) U/gds, at 37 °C of incubation.



**Figure 6** Cellulase activities at varying incubation temperatures on the 9<sup>th</sup> day of incubation at 70% initial moisture and pH 6.0



The present study demonstrated that pre-treated peanut hulls could provide maximum levels of cellulase production after 9 days of fermentation with an initial moisture content of 70%, an initial pH value of 6.0, and the optimum temperature for producing cellulase was 30 °C. The initial moisture content of the growth medium is a critical variable involved in solid-state fermentation. The optimum moisture content in solid-state fermentation depends on the nature of the substrate, humidity requirements of microorganisms and the type of enzyme applied to the production [23]. The results of this study have shown that the production yields of these enzymes at 70% initial moisture are; FPase  $3.214 \pm 0.105$  U/gds, CMCCase  $8.725 \pm 0.121$  U/gds and cellobiase  $0.651 \pm 0.053$  U/gds (Fig. 2-4). However, increasing the moisture level in the solid-state fermentation process showed lower enzyme production which may be attributed to the particle size of the substrate, limited gas exchange and higher risk of bacterial contamination, while low initial moisture content reduced the solubility of the nutrients and the substrate swelling [24]. The pH value of the medium is one of the most critical environmental factors affecting mycelial growth, production of enzymes and transportation of various components across the cell membrane [25]. The cellulase production by *P. sanguineus* was tested at different pH values ranging from 5.0 to 7.0. The fungus produced maximum FPase ( $4.197 \pm 0.191$  U/gds), CMCCase ( $12.303 \pm 0.322$  U/gds) and cellobiase ( $0.824 \pm 0.077$  U/gds) at an initial medium of pH 6.0 (Fig. 5). Increasing the initial pH of the medium (from 6.0 to 7.0) and decreasing the initial pH (from 6.0 to 5.0) caused a slight decrease in the FPase, CMCCase and cellobiase production. Kachlishvili [26] observed that cellular activity was optimal at a pH value of 4.8. A variation of pH values from the optimum range causes denaturation of the enzymes and reduces the enzyme synthesis ability. Temperature is one of the most important physical variables affecting solid-state fermentation [27]. The optimization of the incubation temperature for production of cellulase from *P. sanguineus* under SSF conditions revealed that the enzyme production gradually increased from 25 to 30 °C. (Fig. 6) and maximal enzyme production of all the three enzymes viz. FPase ( $4.437 \pm 0.148$  U/gds), CMCCase ( $11.433 \pm 0.144$  U/gds), and cellobiase ( $0.890 \pm 0.087$  U/gds) was observed at 30 °C. Any increases in temperature beyond 30 °C have an influential effect on the enzyme production. Hanif [28] reported an increase in cellulase production from *Aspergillus niger* at more than 30 °C and there after the production of enzymes decreased. Furthermore, the time course is certainly one of the important factors for the cellulase biosynthesis of fungi, while the maximum yield of the enzyme production occurred in 9 days. These results, demonstrated that the initial levels of moisture, initial pH value and incubation temperature were the most important factors for effective cellulase production.

#### 4. Conclusions

In this study we investigated the feasibility of cellulase enzyme production by using negative cost agro-industrial waste for cheap and feasible enzyme production through simple and cheaper solid-state fermentation technology. In conclusion, solid state fermentation of *P. sanguineus* helped in production of the desired components of cellulase enzyme. In the present study, *P. sanguineus* produced highest amounts of cellulase enzymes were obtained on the 9<sup>th</sup> day of incubation at 70% initial moisture, 30°C, and initial pH 6.0, the enzyme activities of filter paper activity (FPase), carboxymethyl cellulase (CMCase) and cellobiase were  $4.437 \pm 0.148$ ,  $11.433 \pm 0.144$  and  $0.890 \pm 0.087$  unit per gram dry substrate (U/gds) respectively. This study highlighted that solid-state fermentation is a valuable technique for production of complete cellulolytic system with balanced activities that will efficiently hydrolyze complex biomass, such as peanut hulls. The cultures of *P. sanguineus* can be potentially exploited for cellulase enzyme production using peanut hulls as major substrate which is present in abundant quantity. The enzyme activities can be further enhanced by statistical media optimization, provision of aeration during static SSF and controlled conditions during SSF in flasks. Future studies should be intended at the optimization of crucial parameters and scale up studies in bioreactors for cellulase production from peanut hulls which could prove helpful in commercialization of the process.

#### Acknowledgements

The author would like to thank the Department of Chemistry, Faculty of Science, Chiang Mai University and the Faculty of Health Science, Nation University for their contributive support to this research study.

#### References

- [1] Milala, M.A., Shugaba, A., Gidado, A., Ene, A.C. and Wafer, J.A. Studies on the use of agricultural wastes for cellulase enzyme productions by *Aspergillus niger*. Res.J.Agric. Biol. Sci. 2005; 1: 325–328.
- [2] Bansal, N., Tewari, R., Gupta, J.K., Soni, S.K. and Soni, R. A novel strain of *Aspergillus niger* producing a cocktail of industrial depolymerising enzymes for the production of second generation biofuels. BioRes. 2011; 6: 552–569.
- [3] Deswal, D., Khasa, Y.P. and Kuhad, R.C. Optimization of cellulase production by a brown rot fungus *Fomitopsis* sp. RCK2010 under solid state fermentation. Bioresour. Technol. 2011; 102: 6065–6072.
- [4] Jabasingh, S.A. Utilization of pretreated coir pith for the optimized bioproduction of cellulase by *Aspergillus nidulans*. Int. Biodeterior. Biodegradation. 2011; 65: 1150–1160.
- [5] Hacking, A.J., 1987. Economic Aspects of Biotechnology. Cambridge University Press, Cambridge, 317.

- [6] Wooley, R., Ruth S M., MGlassner', D., Sheehan, J. Process design and costing of bioethanol technology: a tool for determining the status and direction of research and development. *Biotechnol. Prog.* 1999; 15, 794–803.
- [7] Rodriguez-Couto, S., Sanroman, M.A. Application of solid-state fermentation to ligninolytic enzyme production. *Biochem. Eng. J.* 2005; 22, 211–219.
- [8] Dhillon, G.S., Brar, S.K., Verma, M., Tyagi, R.D., 2010. Recent advances in citric acid bio-production and recovery. *Food Bioproc. Technol.*, doi:10.1007/s11947-010-0399-0.
- [9] Zhang, Y.P., Lynd, L.R. Toward an aggregated understanding of enzymatic hydrolysis of cellulose: non-complexed cellulase systems. *Biotechnol. Bioeng.* 2004; 88 (7), 797–824.
- [10] Eugenio, M. E., Carbajo, J. M., Martín, J. A., González, A. E. and Villar, J. C. Laccase production by *Pycnoporus sanguineus* under different culture conditions. *J. Basic Microbiol.* 2009; 49: 433–440. doi:10.1002/jobm.200800347
- [11] Zheng W, Phoungthong K, Lü F, Shao LM, He PJ. Evaluation of a classification method for biodegradable solid wastes using anaerobic degradation parameters. *Waste. Manag.* 2013; 33: 2632-2640.
- [12] Agricultural Marketing and Resource Center (AgMRC) (2015) Iowa State University.
- [13] FAOSTAT (2015) Food and Agricultural Organization Statistics.
- [14] Zhao X, Chen J, Du F. Potential use of peanut by-products in food processing. *J. Food. Sci. Technol.* 2012; 49: 521-529.
- [15] Philippoussis AN, Zervakis G, Diamantopoulou P. Bioconversion of agricultural lignocellulosic wastes through the cultivation of the edible mushrooms *Agrocybe aegerita*, *Volvariella volvacea* and *Pleurotus spp.* *World. J. Microbiol. Biotechnol.* 2001; 17: 191-200.
- [16] Kerr TJ, Windham WR, Woodward JH Chemical Composition and In vitro Digestibility of Thermochemically Treated Peanut Hulls. *J Sci Food Agric.* 1986; 37: 632-636.
- [17] Bharthare, P., Shrivastava, P., Singh, P. and Ttiwari, A. Peanut shell as renewable energy source and their utility in production of ethanol. In *ijoar journal*, ijoar.org.2014; 2: 2320-9178.
- [18] Wilson K, Yang H, Seo CW, Marshall WE. Select metal adsorption by activated carbon made from peanut shells. *Bioresour Technol.* 2006; 97: 2266-2270.
- [19] Xia, L. and Cen, P.L. Cellulase production by solid state fermentation on lignocellulosic waste from the xylose industry. *Proc. Biochem.* 1999; 34: 909- 912.
- [20] Ramesh, C.K, Richa, S., Hena, D., Som, D. and Arvind, G. A rapid and easy method for the detection of microbial cellulases on agar plates using gram's iodine. *Curr Microbiol.* 2008; 57: 503-507.
- [21] Ghose, T.K. Measurement of cellulase activities. *International union of pure and applied chemistry. Pure Appl. Chem.* 1987; 59: 257–268.
- [22] Miller, G.L. Use of dinitrosalicylic acid reagent for determination of reducing sugar. *Anal. Chem.* 1959; 31: 426–428.
- [23] Kalogeris, E., Christakopoulos, P., Katapodis, P., Alexiou, A., Vlachou, S., Kekos, D. and Macris, B.J. Production and characterization of cellulolytic enzymes from the thermophilic fungus *Thermoascus aurantiacus* under solid state cultivation of agricultural wastes. *Proc. Biochem.* 2003; 38: 1099–1104.
- [24] Hamidi-Esfahani, Z., Shojaosadati, S.A. and Rinzema, A. Modeling of simultaneous effect of moisture and temperature on *A. niger* growth in solid-state fermentation. *Biochem. Eng. J.* 2004; 21: 265–272.
- [25] Kapoor, M., Nair, L.M. and Kuhad, R.C. Cost effective xylanase production from free and immobilized *Bacillus pumilus* strain MK001 and its application in saccharification of *Prosopis juliflora*. *Biochem. Eng. J.* 2008; 38: 88–97.
- [26] Kachlishvili, E., Penninckx, M., Tsiklauri, N. and Elisashvili, V. Effect of nitrogen source on lignocellulolytic enzyme production by white-rot basidiomycetes under solid-state cultivation. *World J. of Microbiol Biotechnol.* 2006;4: 391-97.
- [27] Krishna, C. Solid-state fermentation systems – An Overview. *Crit. Rev. Biotechnol.* 2005; 25: 1–30.
- [28] Hanif, A., Yasmeen, A. and Rajoka, M.J. Induction, production, repression and derepression of exoglucanase synthesis in *Aspergillus niger*. *Bioresour. Technol.* 2004; 94: 311–319.